

# INSTALLATION AND OPERATORS MANUAL

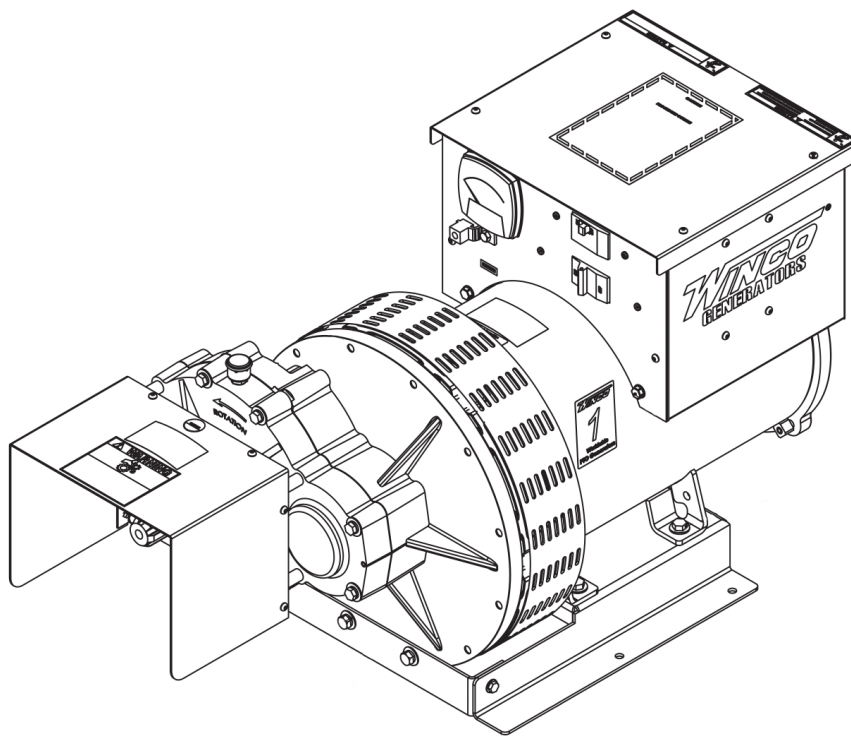

COPY YOUR MODEL AND SERIAL NUMBER HERE  
No other WINCO generator has the same serial number as yours.  
If you should ever need to contact us on this unit, it will help us to  
respond to your needs faster.

MODEL \_\_\_\_\_

SERIAL NUMBER \_\_\_\_\_

PURCHASE DATE \_\_\_\_\_

DEALER NAME \_\_\_\_\_

DEALER PHONE # \_\_\_\_\_

# TABLE OF CONTENTS

# SAVE THESE INSTRUCTIONS

## SAVE THESE INSTRUCTIONS

**2**

## SAFETY

**3**

## SPECIFICATIONS

**4**

GEAR LUBE  
27PTOC4-03  
27PTOT4-03  
30PTOC4-04  
30PTOT4-04  
30PTOC4-17  
30PTOT4-17  
35PTOC4-18  
35PTOT4-18  
35PTOC4-21  
35PTOT4-21

## INTRODUCTION

TESTING POLICY

**5**

## PREPARING THE UNIT

UNPACKING

**6**

## INSTALLATION

**7**

FOUNDATION MOUNTING  
TRAILER MOUNTING  
THREE-POINT HITCH KIT

## ELECTRICAL CONNECTIONS

**8**

GROUNDING  
PLUG KIT

## OPERATION

**11**

## PRE-START CHECKS

**12**

## GENERATOR PROCEDURES

**13**

START-UP  
SHUTDOWN

## MAINTENANCE

**14**

GENERAL INFORMATION  
PERIODICAL MAINTENANCE  
LUBRICATION  
CLEANING & INSPECTION  
GENERATOR STORAGE

## TROUBLE SHOOTING TABLE

**16**

## WIRING DIAGRAM

**17**

120/240V SINGLE PHASE  
120/208V & 120/240V THREE PHASE  
277/480V THREE PHASE

## 36 MONTH LIMITED WARRANTY

**20**

## LIMITED WARRANTY

**20**

This manual contains important instructions that should be followed during installation and maintenance of the generator. Read and understand all instructions in the manual before starting and operating the generator.

### USING THIS MANUAL

Congratulations on your choice of a WINCO generator. You have selected a high-quality, precision-engineered generator designed and tested to give you years of satisfactory service.

To get the best performance from your new generator, it is important that you carefully read and follow the operating instructions in this manual.

Should you experience a problem please follow the "Troubleshooting Tables" near the end of this manual. The warranty listed in the manual describes what you can expect from WINCO should you need service assistance in the future.

# SAFETY

## IMPORTANT SAFETY INSTRUCTIONS

This engine generator set has been designed and manufactured to allow safe, reliable performance. Poor maintenance, improper or careless use can result in potentially deadly hazards; from electrical shock, or fire. Please read all safety instructions carefully before installation or use. Keep these instructions handy for future reference. Take special note and follow all warnings on the unit labels and in the manuals.

## SAFETY DEFINITIONS

<b>DANGER</b>	Indicates an imminently hazardous situation which, if not avoided, will result in death or serious injury.
<b>WARNING</b>	Indicates a potentially hazardous situation which, if not avoided, could result in death or serious injury.
<b>CAUTION</b>	Indicates a potentially hazardous situation which, if not avoided, may result in minor or moderate injury. It may also be used to alert against unsafe practices.

### CALIFORNIA PROPOSITION 65



**WARNING:** This product contains crude oil, gasoline, diesel fuel and other petroleum products, Antifreeze to which can expose you to chemicals including toluene and benzene, Ethylene glycol (ingested) which are known to the State of California to cause cancer, birth defects or other reproductive harm and developmental issues. For more information go to [www.P65Warning.ca.gov](http://www.P65Warning.ca.gov).

### DANGER: ELECTRICAL SHOCK

The output voltage present in this equipment can cause fatal electric shock. This equipment must be operated by a responsible person.

- Do not allow anyone to operate the generator without proper instruction.
- Guard against electric shock.
- Avoid contact with live terminals or receptacles.
- Use extreme care if operating this unit in rain or snow.
- Use only three-pronged grounded receptacles and extension cords.
- Be sure the unit is properly grounded for your application.

### WARNING: FIRE HAZARD

Keep a fire extinguisher nearby and know its proper use. Fire extinguishers rated ABC by NFPA are appropriate.

### CAUTION: NOISE HAZARD

Excessive noise is not only tiring, but continual exposure can lead to loss of hearing.

- Use hearing protection when working around this equipment for long periods of time.
- Keep your neighbors in mind when using this equipment.

### CAUTION

- Keep the generator and surrounding area clean.
- Remove all grease, ice, snow or materials that create slippery conditions around the unit.
  - Remove any rags or other materials that could create a potential fire hazard.
  - Carefully clean up any gas or oil spills before starting the unit.

### CAUTION

All service, including the installation or replacement of service parts, should be performed only by a qualified technician.

- Use only factory approved repair parts.
- Do not work on this equipment when fatigued.
- Never remove the protective guards, covers, or receptacle panels while the engine is running.
- Use extreme caution when working on electrical components. High output voltage from this equipment can cause serious injury or death.

### WARNING

Installing a PTO generator is not a "do-it-yourself" project. Consult a qualified, licensed electrician or contractor. The installation must comply with all national, state, and local codes.

- Never operate the PTO drive generator without having it properly mounted to a concrete base or approved trailer.
- Never connect the PTO generator to an existing electrical system without installing an isolation transfer switch.
- Always insure the drive shaft is straight and level before operating the generator.

### WARNING

PTO drive shafts (tumbling bars) have many inherent dangers, extreme caution must be exercised when using them.

- NEVER allow children around the drive shaft when it is in operation.
- Keep all safety guards and shields in place and securely tightened.
- Never operate a drive shaft that has been damaged or had the safety shield removed.
- Never step over a drive shaft while it is running.
- Never wear a necktie, loose articles of clothing, or anything else that can be caught in moving parts.
- Never try to stop drive shaft with your hand or your foot.

# SPECIFICATIONS

## GEAR LUBE

Volume 0.875 Pint  
Type SAE 80-90W-140

## 27PTOC4-03

Watts 27,600  
Volts 120/240  
Phase Single  
Amps 115  
Input Speed 540 RPM  
Generator Speed 1800 RPM  
AVR AS540  
Input Shaft 1 3/8" 6-spline  
Required Tractor PTO HP 54

## 27PTOT4-03

Watts 27,600  
Volts 120/240  
Phase Single  
Amps 115  
Input Speed 1000 RPM  
Generator Speed 1800 RPM  
AVR AS540  
Input Shaft 1 3/8" 6-spline  
Required Tractor PTO HP 54

## 30PTOC4-04

Watts 31,600  
Volts 120/208  
Phase Three  
Amps 87  
Input Speed 540 RPM  
Generator Speed 1800 RPM  
AVR AS540  
Input Shaft 1 3/8" 6-spline  
Required Tractor PTO HP 63

## 30PTOT4-04

Watts 31,600  
Volts 120/208  
Phase Three  
Amps 87  
Input Speed 1000 RPM  
Generator Speed 1800 RPM  
AVR AS540  
Input Shaft 1 3/8" 6-spline  
Required Tractor PTO HP 63

## 30PTOC4-17

Watts 31,600  
Volts 120/240  
Phase Three  
Amps 87  
Input Speed 540 RPM  
Generator Speed 1800 RPM  
AVR AS540  
Input Shaft 1 3/8" 6-spline  
Required Tractor PTO HP 63

## 30PTOT4-17

Watts 31,600  
Volts 120/240  
Phase Three  
Amps 87  
Input Speed 1000 RPM  
Generator Speed 1800 RPM  
AVR AS540  
Input Shaft 1 3/8" 6-spline  
Required Tractor PTO HP 63

## 35PTOC4-18

Watts 36,000  
Volts 277/480  
Phase Three  
Amps 54  
Input Speed 540 RPM  
Generator Speed 1800 RPM  
AVR AS540  
Input Shaft 1 3/8" 6-spline  
Required Tractor PTO HP 72

## 35PTOT4-18

Watts 36,000  
Volts 277/480  
Phase Three  
Amps 54  
Input Speed 1000 RPM  
Generator Speed 1800 RPM  
AVR AS540  
Input Shaft 1 3/8" 6-spline  
Required Tractor PTO HP 72

## 35PTOC4-21

Watts 36,000  
Volts 346/600  
Phase Three  
Amps 43  
Input Speed 540 RPM  
Generator Speed 1800 RPM  
AVR AS540  
Input Shaft 1 3/8" 6-spline  
Required Tractor PTO HP 72

## 35PTOT4-21

Watts 36,000  
Volts 346/600  
Phase Three  
Amps 43  
Input Speed 1000 RPM  
Generator Speed 1800 RPM  
AVR AS540  
Input Shaft 1 3/8" 6-spline  
Required Tractor PTO HP 72

# INTRODUCTION

---

## TESTING POLICY

Before any generator is shipped from the factory, it is fully checked for performance. The generator is loaded, and the voltage, current, and frequency are carefully checked.

Rated output of generator is based on engineering tests of typical units, and is subject to, and limited by, the temperature, altitude, fuel, and other conditions specified by the tractor manufacturer.

The WINCO power take-off generators are designed primarily for farm use as a standby electrical power supply, utilizing the power take-off of a tractor or truck as the prime mover. This PTO drive generator will provide, 120/240V 1-PH, 120/208V 3-PH, 120/240V 3-PH, or 277/480V 3-PH (depending on model), 60Hz electrical service when properly driven.

**DO NOT** operate and/or store the unit outside during inclement weather without adequate protection from the elements. Failure to do so will damage the unit.

It is acceptable to use this generator with a tractor with less HP output than required for full power operation. The generator will work but produce only as much kW output as the tractor can supply HP for. For example, a 20 HP output tractor will deliver a maximum of approximately 10 kv.

If you are using a tractor with more HP than required to run the generator care should be taken to ensure that you do not overload the generator causing overheating and equipment damage. Observe input RPM specifications.

The generator may be foundation mounted for use as standby power source, or trailer mounted, and used as portable electrical power sources for areas where commercial power is not readily available, such as out buildings.

This generator includes a frequency meter to warn against high or low frequency, three output power receptacles, an overload protection circuit, and an electronic excitation circuit. To reduce maintenance problems, the coupling between the generator input shaft and rotor consists of precision helical gearing rather than a chain link drive. The input shaft is a 1 3/8in. 6-spline.

**IMPORTANT: THE MANUFACTURER STRONGLY RECOMMENDS RUNNING THE GENERATOR UNDER LOAD AT LEAST ONCE A MONTH IN ORDER TO EVAPORATE ANY ACCUMULATED MOISTURE CONDENSATION.**

# PREPARING THE UNIT

---

## UNPACKING

### CAUTION: EQUIPMENT DAMAGE

When you unpack your new generator, be sure to remove all of the information sheets and manual from the carton.

1. As you receive your unit, it is critical to check it for any damage. If any damage is noted, it is always easiest to refuse the shipment and let WINCO take care of the freight claim. If you sign for the unit, the transfer of the ownership requires that you file the freight claim
2. Before proceeding with the preparations of your new generator for operation, take a couple of minutes to ensure the unit you have received is the correct model and review the specification pages in this manual to ensure that this unit meets your job requirements.



# INSTALLATION

## FOUNDATION MOUNTING

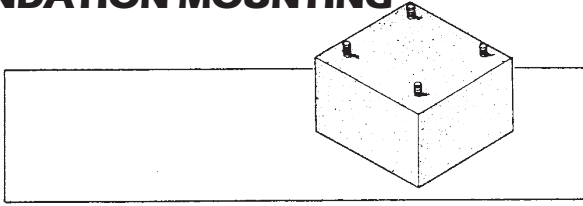

Mount the generator on a foundation if it is to be used as a permanent or standby power source. When planning a foundation consider the following points:

- A. The foundation location should enable aligning the drive shaft (tumbling bar) in a straight or nearly straight line between the power take-off and the generator input shaft. Misalignment must be less than 5 degrees during generator operation, even though the mechanical design of the tumbling bar would allow greater misalignment.
- B. The foundation must be solid enough to absorb generator starting and reflected load torque during operation.
- C. The foundation surface should be flat.
- D. Space is required around the generator for mounting switching devices, making connections, and for servicing.
- E. For dimensions needed for install for your specific generator, please refer to it's outline drawing. The hardware needed is dependent on your distinct application.
- F. The generator mounting bracket must rest evenly and firmly on the foundation. Install shims if necessary to even out the foundation under the mounting pads then bolt the generator firmly in place.

## TRAILER MOUNTING

Optional



Mount the generator on a trailer if you plan to use it as a portable power source. When selecting or building a trailer to mount the generator, consider the following points:

- A. The trailer construction must be strong enough to support the generator.
- B. The design of the trailer must enable the trailer to remain stable during operation, and to resist tipping caused by generator starting and reflected load torque.

C. The trailer height and mounting position of the generator on the trailer should enable aligning the drive shaft (tumbling bar) in a straight or nearly straight line between the power take-off and generator input shafts. Misalignment must be less than 5 degrees during generator operation, even though the mechanical design of the tumbling bar would allow greater misalignment.

D. The generator mounting area of the trailer bed should be flat.

The frame pads must rest firmly on the trailer bed. Install shims if necessary to even out the bed under the mounting pads, then bolt the generator firmly in place.

### WARNING: Personal Injury & Equipment Damage

Trailer may tip over and cause injuries if wheels are not spaced far enough apart.

## THREE-POINT HITCH KIT

Optional



### WARNING: PERSONAL INJURY & EQUIPMENT DAMAGE

When using the 3-point hitch assembly all three points must be attached to the tractor. Failure to do so will cause the generator to tip when lifting it, damaging both the t-bar and the generator.

- A. The three point hitch must be attached to the tractor at all times during operation.
- B. When operating the generator the three point hitch and generator must be sitting on flat level ground. All four deck pads must be in constant contact with the ground at all times. This will reduce the vibration in both the generator and the tumbling bar.
- C. For safety the generator must be bolted to the three point hitch deck using all four mounting bolts.

# ELECTRICAL CONNECTIONS

## GROUNDING

Proper grounding of your generator is application dependent. Carefully evaluate your planned use of your generator to understand which grounding you require. If you are not sure what to do, contact a competent professional to assist you. The NFPA 70 250:34-35 are good technical references.

### STANDARD PORTABLE GENERATOR

Your WINCO portable generator ships with a bonded neutral. You can safely use this generator without external grounding as long as all loads are powered through the receptacle panel.

### VEHICLE-MOUNTED GENERATOR

Your WINCO portable generator ships with a bonded neutral. When mounted to a vehicle to safely distribute power it is necessary that the generator frame is bonded to the vehicle frame. The generator should only supply equipment that is cord and plug connected through receptacles mounted on the generator or the vehicle.

### PERMANENTLY INSTALLED GENERATORS

This WINCO portable generator ships with a bonded neutral and overcurrent protection. NFPA 70 refers to this as a "separately derived system." When connecting it to a building a transfer switch specifically designed for GFCI and bonded neutral generators is required.

#### CAUTION:

Only qualified electricians should install electrical wiring. Wiring must conform to all applicable national, state, and local codes. (Reference: National Fire Protection Association Manual No. 70, National Electrical Code.)

#### DANGER: PERSONAL INJURY:

A manual transfer switch must be installed to separate the generator and the commercial power lines. The switch must isolate the generator from the commercial power lines and the load when the generator is on standby, and must isolate the commercial power lines from the load and the generator when the generator is supplying power. See the following diagrams.

A properly rated and installed double throw manual power isolation transfer switch must be used with a standby generator. The transfer switch isolates the load from the power line and allows you to safely operate your loads without endangering the power line repair crew. See diagram on page 8.

The load, connected to the normal terminals of the transfer switch, is energized by the normal power line when the switch is in the normal position. The generator, connected to the emergency terminals of the switch, furnishes power when the switch is in the emergency mode position.

There are two ways to install a manual transfer switch. The first shown on the left side of the diagram on page 8, is to

install the switch between the watt-hour meter and the normal distribution panel. As with any system you must install an entrance rated breaker before the manual transfer switch. The manual transfer switch must in all cases be equal to or greater than the rating of the entrance rated breaker.

The second way to install the system is to purchase and install an emergency distribution panel and move the circuits you wish to back up to the new distribution panel. In this case the manual transfer switch only has to be sized to the amperage of the circuit breaker in the main distribution panel that is feeding it. See the right hand drawing of the diagram on page 8.

Before deciding which system to install, first determine which loads you can safely run on your PTO generator and the cost of buying a large manual transfer switch versus the cost of a smaller switch and the additional distribution panel.

## PLUG KIT

The bag contains an instruction sheet, 2 plug bodies, four contacts, two handle and the hardware to assembly the disconnect plug. You will need to purchase the appropriate length of fine stranded copper wire for your application in order to complete the assembly of the disconnect plug. Your application and local code will determine the type of wire used. WINCO's recommended wire size is given in each plug kit.

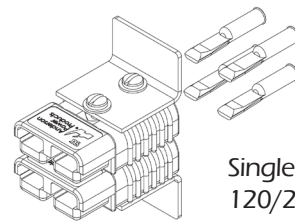

Single Phase  
120/240V

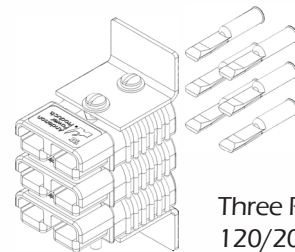

Three Phase  
120/208V & 120/240V

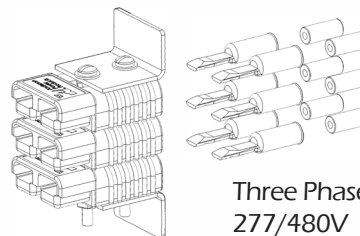

Three Phase  
277/480V

If you require different inserts or contacts for local code, WINCO has a variety of different inserts and contacts available. Contact the factory at 507-357-6831 for pricing.



### **WARNING: EQUIPMENT DAMAGE**

Never use acid core solder. When soldering insure no excess solder runs down on the contact surface - Solder on the contact surface will not allow the contacts to mate properly causing them to burn up.

Each wire should be stripped back 7/8 of an inch and inserted into one of the contacts in the plug kit. You will then either need to solder them together using a good grade of resin core solder or they can be crimped with an appropriate compression crimper or both.

Approved Crimping tools are:

1. Anderson Power Products
2. ETC Model HHS hydraulic crimper
3. ITT Blackburn NO. 1640
4. T&B (Thomas & Betts) #TBM5

To complete the assembly of the disconnect plug refer to the instruction sheet in the plug kit.

### **WARNING: ELECTRICAL SHOCK**

DURING THE NEXT STEP, THE LOAD DISCONNECT PLUG SHOULD NOT BE PLUGGED INTO ITS RECEPTACLE. ALSO, MAKE SURE THAT THE EQUIPMENT TO WHICH THE PLUG LEADS (CABLES) ARE BEING CONNECTED IS NOT ENERGIZED (LIVE).

Strip the insulation off the free end of each of the plug leads (cables), and connect them to the load transfer switch (or directly to the load).

## TYPICAL CONNECTION METHODS FOR GENERATOR POWER SERVICE

**IMPORTANT: When making standby service hook up, make sure load to be transferred to standby generator will not exceed generator rating.**

TYPICAL HOOK UP FOR SUPPLYING ALL CIRCUITS WITH EMERGENCY POWER

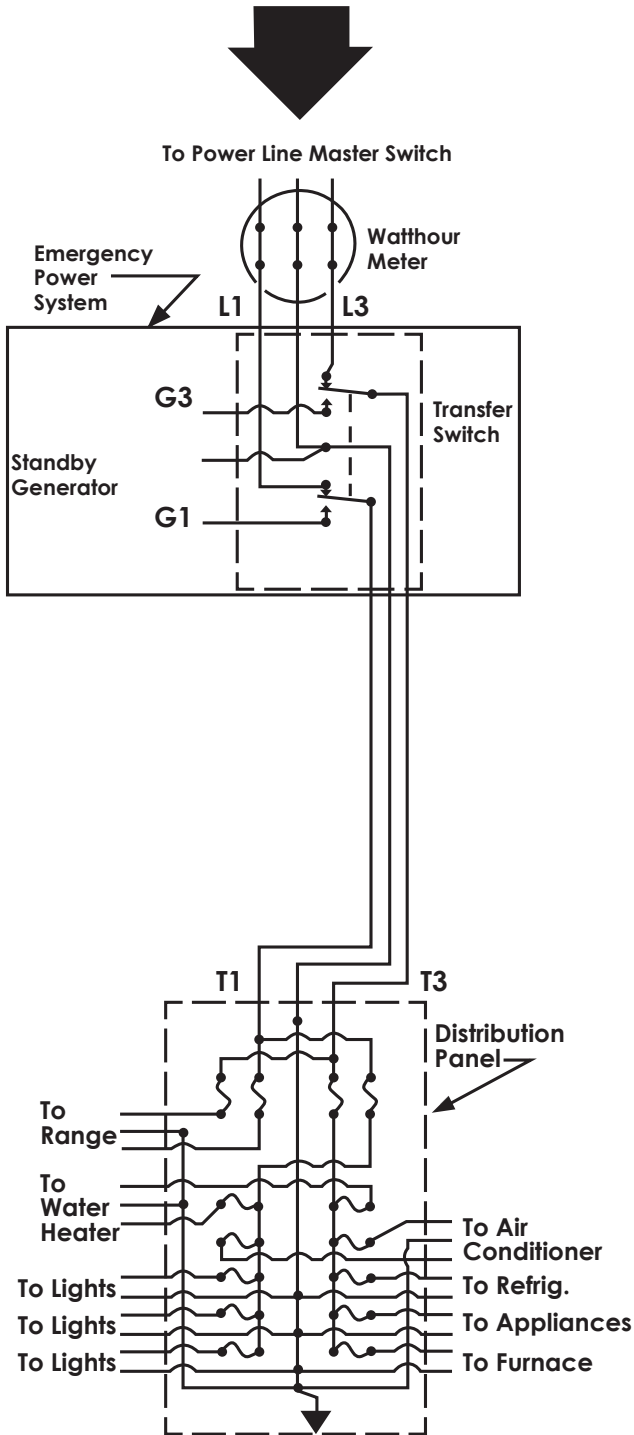

TYPICAL HOOK UP FOR SUPPLYING ONLY ESSENTIAL CIRCUITS WITH EMERGENCY POWER

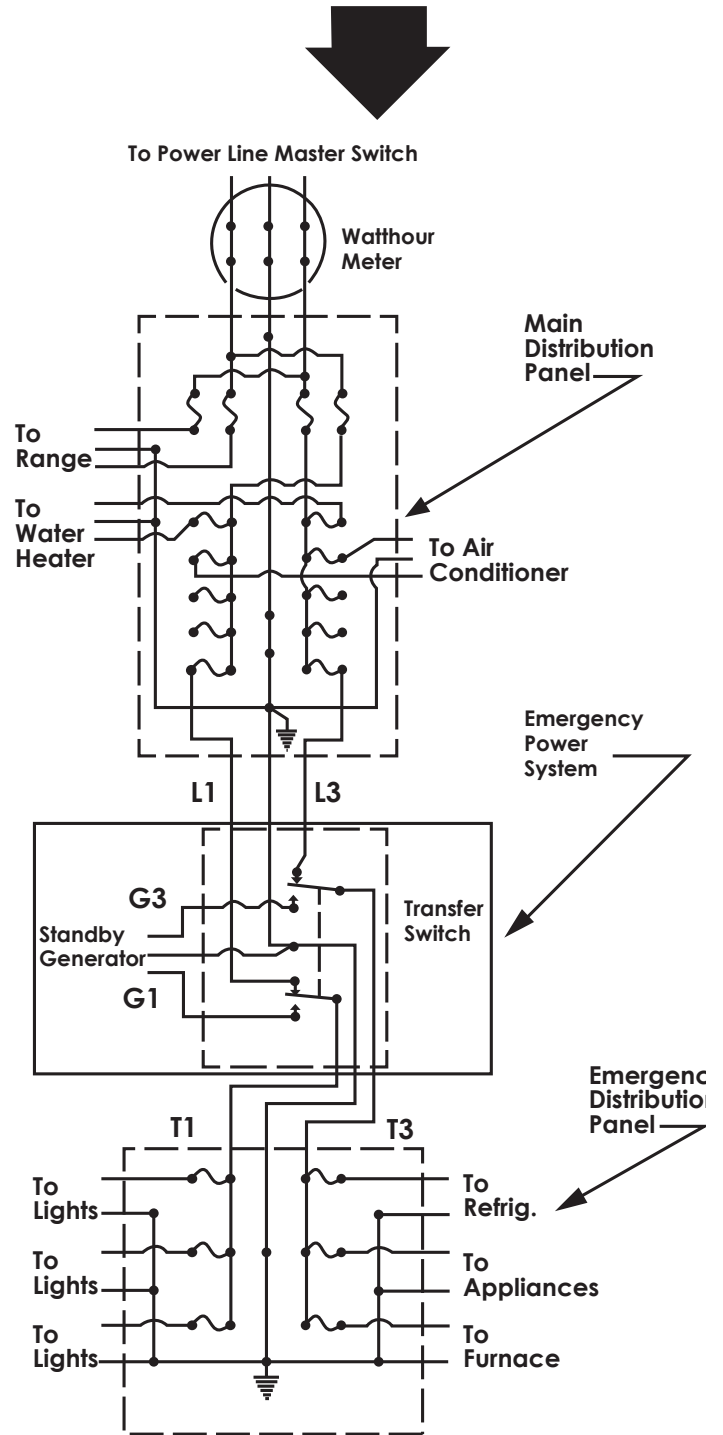

# OPERATION

---

## OUTPUT POWER AVAILABLE AND LOAD DETERMINATION

Before using the generator, read and understand the following information.

Generator output current (amperage) is internally limited by three circuit breakers. If too much demand is placed on a generator output (if you try to drive too many motors with it, for example), one of the circuit breakers will trip, cutting off the output in order to protect the generator.

A 20 Amp push-to-reset circuit breaker protects the 120V duplex receptacle output circuit. 20 Amps is the total limit for both outputs of the duplex receptacle. The 480V is equipped with the Anderson receptacle only.

A 50 Amp toggle circuit breaker protects the 240V receptacle output circuit. The 480V is equipped with the Anderson receptacle only.

A large two pole (three pole for three phase) switch type main circuit breaker protects the generator windings and output circuits, including the load disconnect receptacle outputs. The load disconnect receptacle is the largest gray receptacle on the generator output panel.

To aid in determining how much load can be applied to the generator, and how it should be distributed among the generator output receptacles, the following formulas may be useful. Get load voltages, current, and wattage from the nameplates on the equipment in the load.

Load current (in Amps) x Load voltage = Load wattage  
Amps x Volts = Watts  
Watt/1000 = kW

Load wattage / Load voltage = Load current (in Amps)

Example: 250W, 120V floodlight load:  $250W / 120V = 2$  Amps

### NOTE:

Electric motors require more current to start than to run. Commonly, the current rating given on a motor nameplate is the full load (running) current required by the motor, not its starting current, which is a lot higher. Motor starting current requirements vary greatly, by motor size and type. Repulsion-induction type motors are the easiest to start, typically using 1 1/2 to 2 1/2 times as much current to start as to run. Capacitor type motors usually require 2 to 4 times as much current to start as to run. Split-phase type motors are the hardest to start, normally using 5 to 7 times as much current to start as to run.

# PRE-START CHECKS

## WARNING: PERSONAL INJURY

When working on or around these generators, do not wear loose fitting clothing or any articles that may get caught in moving parts.

1. Visually inspect the generator. Check for:
  - A. Correct mounting
  - B. Physical damage
  - C. Debris in cooling vents and screens (could cause generator to overheat)

**IMPORTANT:** The manufacturer recommends that, if the generator has been stored for any length of time, before using it, the operator removes the control box cover and cooling fan screen. Then inspect the generator for rodent nests or other objects that could cause the generator binding and/or overheating. See "cleaning portion of the Maintenance section.

2. Check gearcase oil level by removing the plug located on the backside of the gearcase marked "OIL LEVEL". To refill oil, see LUBRICATION in the MAINTENANCE section in this manual.

**NOTE:** Either too little or too much oil can harm the equipment.

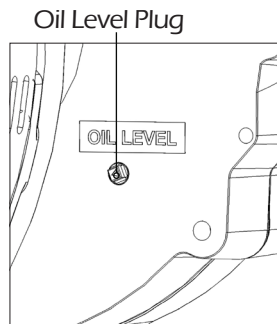

3. Make sure the drive shaft (tumbling bar) is assembled with its universal joint knuckles "synchronized". If the knuckles are not synchronized, the bar will chatter when rotating, which will cause the generator output voltage to flicker.

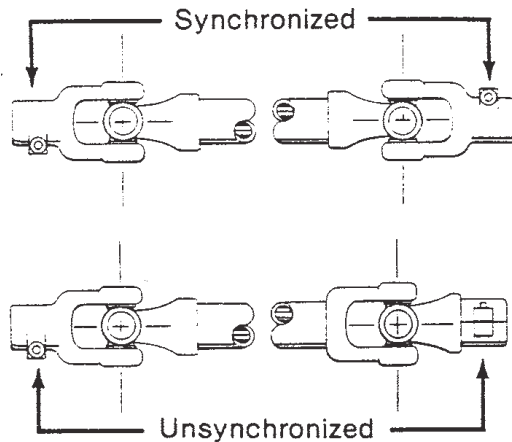

## DANGER: PERSONAL INJURY

Power take-off must be **DISENGAGED** at this time.

4. Couple the tractor to the generator with the drive shaft (tumbling bar). Couple the tumbling bar to the generator input shaft first, then to the power take-off shaft. Check alignment, tractor, power take-off shaft (tumbling bar), and the generator input shaft should form a straight (or nearly straight) line, with less than 5 degrees misalignment between the shafts. Misalignment will cause generator output voltage to flicker.

## CAUTION:

Make sure that all tumbling bar lock pins are engaged and that all safety shields are in place before operating the PTO generator.

5. Make sure no binding exists in generator or gearbox. If binding is found, locate the cause and correct it before proceeding.
6. Make sure that the electrical loads to be driven by the generator will not draw more current than the ratings of the generator receptacle or cord set which will supply the current.
7. Check all electrical connections in the system to be energized by the generator. Make sure the connections are correct and are tight.
8. Make sure all loads are turned off. Do not start generator under load.

# GENERATOR PROCEDURES

---

## START-UP

1. With the power take-off drive disengaged, start the engine which will drive the generator. Run the engine long enough to warm it up before proceeding, so that it will run smoothly and achieve full power under generator load.
2. With the engine idling, engage the power take-off drive.
3. Watch the frequency meter on the generator and slowly increase engine speed until frequency reaches approximately 60 Hz. The voltage output of the generator is controlled by an Automatic Voltage Regulator (AVR). Before turning on any load, check your voltage output from the generator using a Volt/OHM meter. If the voltage is either high or low, adjust the voltage level by turning the voltage adjustment screw on the AVR. The AVR is located inside the generator control cabinet. Once the proper voltage level is set, the AVR should bring the voltage back to the same level each time the unit is started up. But, as a precaution, it should be checked each time you use the generator. As a quick check you can plug in a trouble light and check for normal brightness.
4. With engine and generator running smoothly, switch on the electrical load while watching the frequency meter

### CAUTION: EQUIPMENT DAMAGE

If the load includes motors, turn them on one at a time, highest starting current motor first, next highest second, etc.

Adjust engine throttle to keep generator output under load at 60Hz. If the engine is equipped with a governor, it may automatically adjust the throttle as the load changes and keep the generator output at the proper level. However, some governors are not sensitive enough to maintain proper output under changing loads, and in such cases, the frequency will have to be monitored closely and manually adjusted.

## SHUTDOWN

1. Switch off electrical load.
2. Reduce Speed of engine driving generator to idle.
3. Disengage power take-off drive and allow generator to coast to a stop.

### WARNING: PERSONAL INJURY

Never try to manually stop the generator. Always let it coast until it stops.

4. Shut off the engine.
5. Disconnect drive shaft. Power take-off end first, then the generator end.

# MAINTENANCE

## GENERAL INFORMATION

The main components of the generator are: rotor and stator assembly, cooling fan, brushes, brush holder assembly, end brackets. Before performing any maintenance on the generator, isolate and/or disable the drive system so the unit can not be accidentally started while being repaired.

The trouble shooting chart lists various symptoms of poor generator operation with possible causes and the appropriate corrective action. You will need a volt-ohm meter or test light to check some of the causes. For some of the other causes you will need to check generator speed. To check generator speed, you can use a frequency meter, a tachometer, or a 120V-60Hz electric clock and a correctly operating wrist watch (run the electric clock and a correctly power and compare the clock's second hand movement with that of the wrist watch. They should run at the same speed. If the clock runs faster, generator speed is too high, and vice versa).

### CAUTION: EQUIPMENT DAMAGE

Most electrical equipment in North America operates satisfactory at frequencies between 58.5 and 62 Hz (cycles per second). Operating the generator at frequencies outside that range may cause damage to the generator and/or to electrical equipment driven by the generator.

## PERIODICAL MAINTENANCE

Service/maintenance items include periodic external physical inspection for missing hardware or damage to mounting or drive system and checking the oil level in the gearcase. It is recommended that the generator be operated at least monthly under normal loads to familiarize operators with the procedures and controls as well as to dry out any accumulated condensation or other moisture in the generator electrical windings. The maintenance and service attention invested will ensure getting the peak performance that was designed to the unit.

Routine preventative maintenance minimizes costly repairs and generator down-time. Before each use, inspect the generator: gearcase oil level should be correct, cooling vents and screens should be clear, and generator mounting hardware should be tight. Clean and inspect the generator after storing it for long periods, and after using it in extremely dusty conditions or in severe weather, such as rain or blowing snow.

## LUBRICATION

The generator bearings are factory lubricated and sealed, and require no further lubrication.

The generator input shaft should be cleaned and lubricated with a thin film of grease before installing the drive shaft and each time it is removed.

The drive shaft (tumbling bar) requires greasing. Keep the universal joints in the coupling shaft free from grease and dirt build-up.

NOTE:  
Do not over lubricate the universal joints.

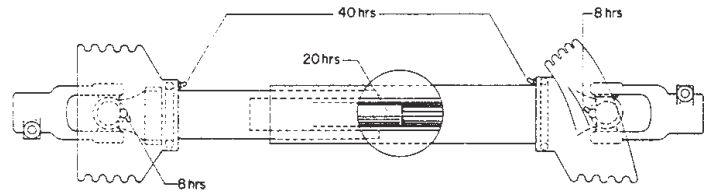

Check the generator gearcase oil level before each use of the generator. Maintain the oil level at the oil level plug height. The generator is shipped with lubricant in the gearcase. Specifications for the gearcase lubricant are:

API Service: GL-5  
Grade: SAE 85W-90-140  
Amount: 0.875 Pints

The following kind of oil are recommended for use in the generator gearcase: Mobile SAE 85W-90-140 API Service GL-5, Sunonco/DX XL80W90-140, Kendal Three Star 85W-140, Amoco 85W140 or equivalent.

### CAUTION: EQUIPMENT DAMAGE

Do not overfill generator gearcase. Overfilling causes overheating and oil seal failure.

Change oil at least once every twelve months or 150 hours of operation. Change it more often if you use the generator in bad weather. Use the following procedure to change generator gearcase oil:

1. Remove gearcase breather. Soak breather in cleaning solvent, then allow to dry.

Breather Vent

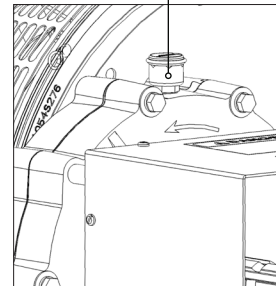

2. Remove oil level check plug.

Oil Level Plug

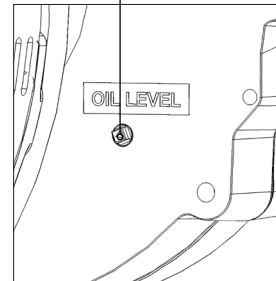

3. Remove the oil drain plug, drain the oil into a clean oil resistant container, 1 quart or larger. Check the oil for



metal. Fine metal dust in the oil does not indicate trouble, but metal chips do. Dismantle the gearcase and look for damaged gears if you find metal chips in the oil.

4. Replace the oil drain plug. Refill the gearcase through the breather port with new oil of the recommended type. Fill the case until a little bit of oil comes out of oil level check plug hole (it will take less than 1 pint when dry).
5. Replace the oil level check plug.
6. Replace the breather.

## **CLEANING & INSPECTION**

Use a vacuum cleaner or dry low pressure compressed air (regulated at 25-35 PSI) to clean the generator periodically.

### **WARNING:**

Do NOT clean the generator while it is running.

Proceed as follows:

1. Remove control box cover. Vacuum or blow dust or debris from the control box. Inspect all wiring for correct routing, fraying insulation, and secure connections.
2. Remove end cover. Vacuum or blow dust and debris from the inside of the generator. Inspect wiring for loose connections, fraying insulation and correct wire routing.
3. Replace end cover and control box cover.

## **GENERATOR STORAGE**

Before storing the generator, apply a heavy coat of grease to the splined input shaft. Store the generator in a sheltered area, where it is protected against snow, rain, and excessive dust.

## TROUBLE SHOOTING TABLE

SYMPTOM	POSSIBLE CAUSE	CORRECTIVE ACTION
Low Output Voltage	<ol style="list-style-type: none"> <li>1. Engine speed too slow.</li> <li>2. Generator overloaded.</li> <li>3. Inadequate engine horse power.</li> <li>4. Defective or misadjusted AVR</li> </ol>	<ol style="list-style-type: none"> <li>1. Check engine speed. Increase RPM if necessary.</li> <li>2. Reduce load if it is higher than the rated capacity of the generator. See generator nameplate.</li> <li>3. Generator requires 2.0 HP/1000 Watt output. Obtain larger engine if necessary.</li> <li>4. Adjust, repair, or replace as required</li> </ol>
High Output Voltage	<ol style="list-style-type: none"> <li>1. Engine speed too fast.</li> <li>2. Defective or misadjusted AVR</li> </ol>	<ol style="list-style-type: none"> <li>1. Check engine speed for correct input RPM.</li> <li>2. Adjust, repair, or replace as required</li> </ol>
Excessive Vibration	<ol style="list-style-type: none"> <li>1. Power take-off misalignment excessive.</li> <li>2. Loose mounting nuts and bolts or hold-down studs.</li> <li>3. Universal joints in coupling shaft worn or dry.</li> <li>4. Defective bearings</li> </ol>	<ol style="list-style-type: none"> <li>1. Correct misalignment. It should be less than 15°.</li> <li>2. Tighten mounting nuts and bolts; repair hold-down stud mountings.</li> <li>3. Repair or replace defective parts.</li> <li>4. Check for possible causes. Replace defective bearings.</li> </ol>
No Output Voltage	<ol style="list-style-type: none"> <li>1. Circuit breaker open.</li> <li>2. Short circuit in the load.</li> <li>3. Defective receptacles.</li> <li>4. Loose (or broken) wires or connections in control box.</li> <li>5. Defective rotating rectifier.</li> <li>6. Defective AVR</li> <li>7. Shorted or open rotor.</li> <li>8. Shorted or open stator.</li> </ol>	<ol style="list-style-type: none"> <li>1. Reset circuit breakers, replace if defective.</li> <li>2. Disconnect the load. Check voltage at receptacle cord set. Check motors, appliances, and load leads for short circuit, repair short..</li> <li>3. Remove panel cover and check for voltage to the receptacles. Replace defective receptacles..</li> <li>4. Remove panel cover and check all wiring and connections. Tighten and/or replace where necessary.</li> <li>5. Test rectifier. Replace if defective.</li> <li>6. Repair or replace as required</li> <li>7. Measure rotor resistance. Replace rotor if open or shorted.</li> <li>8. Measure between leads for open or short. Replace stator if defective.</li> </ol>
Output Voltage Flickering or Fluctuating	<ol style="list-style-type: none"> <li>1. Tumbling bar (shaft) misalignment</li> <li>2. Engine governor may be worn or improperly adjusted.</li> <li>3. Loose connection in field circuit</li> <li>4. Tumbling bar u-joints not synchronized.</li> </ol>	<ol style="list-style-type: none"> <li>1. Reduce tumbling bar misalignment to less than 15 degrees.</li> <li>2. Set or repair defective governor.</li> <li>3. Check and tighten connections.</li> <li>4. Reassemble tumbling bar.</li> </ol>
Generator Overheating	<ol style="list-style-type: none"> <li>1. Poor ventilation.</li> <li>2. Generator overloaded.</li> <li>3. Shorted turns in field or armature windings.</li> </ol>	<ol style="list-style-type: none"> <li>1. Clean ventilation and cooling fan screens.</li> <li>2. Reduce load, then check voltage and current.</li> <li>3. Replace defective components.</li> </ol>
Oil Leak	<ol style="list-style-type: none"> <li>1. Loose plug in gearcase.</li> <li>2. Defective seal, gasket, or plug in gearcase.</li> </ol>	<ol style="list-style-type: none"> <li>1. Tighten plug.</li> <li>2. Replaces seal(s), gasket or plugs. Maintain correct oil level.</li> </ol>

# WIRING DIAGRAM

## 120/240V SINGLE PHASE BACK VIEW

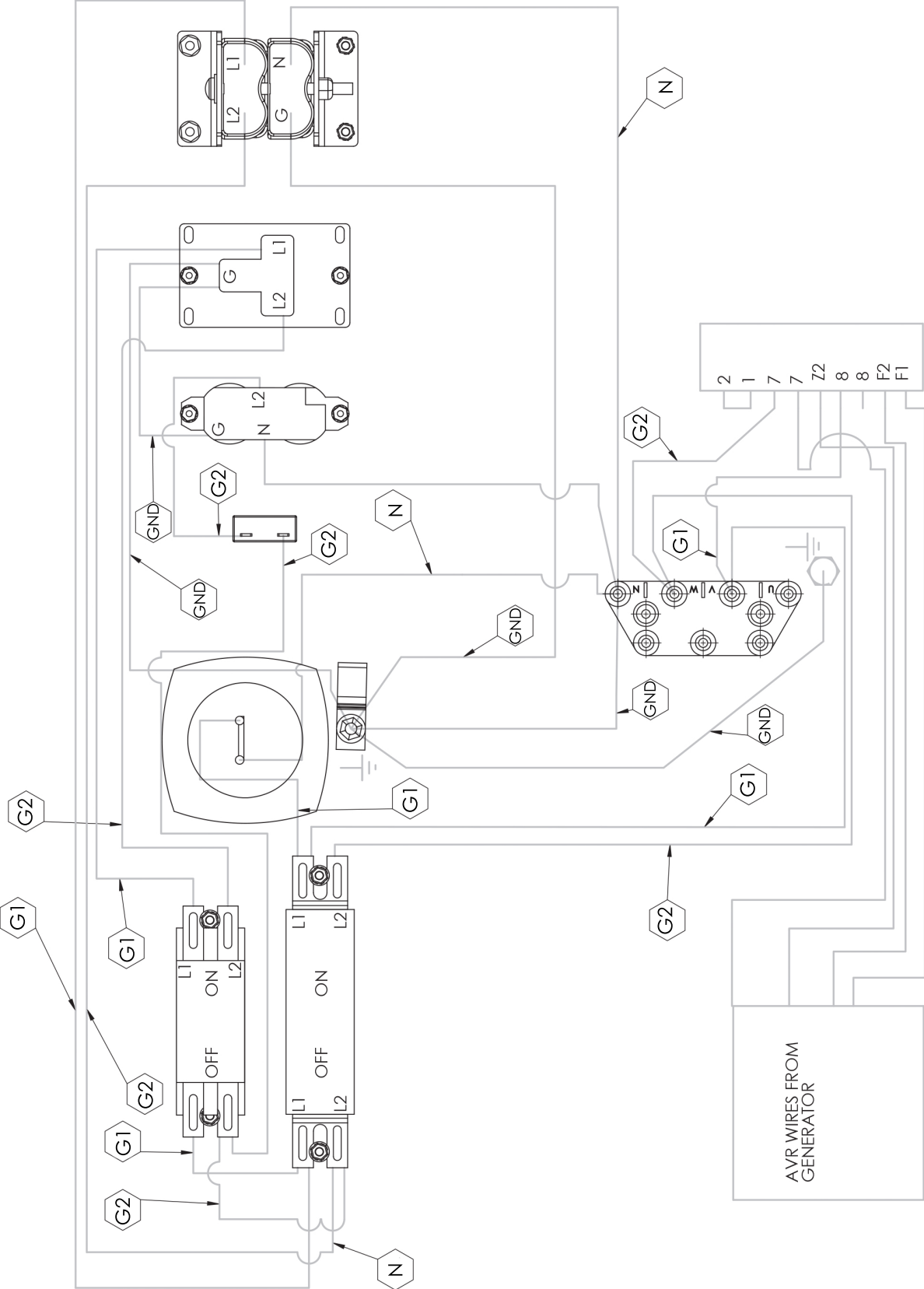

# 120/208V & 120/240V THREE PHASE BACK VIEW

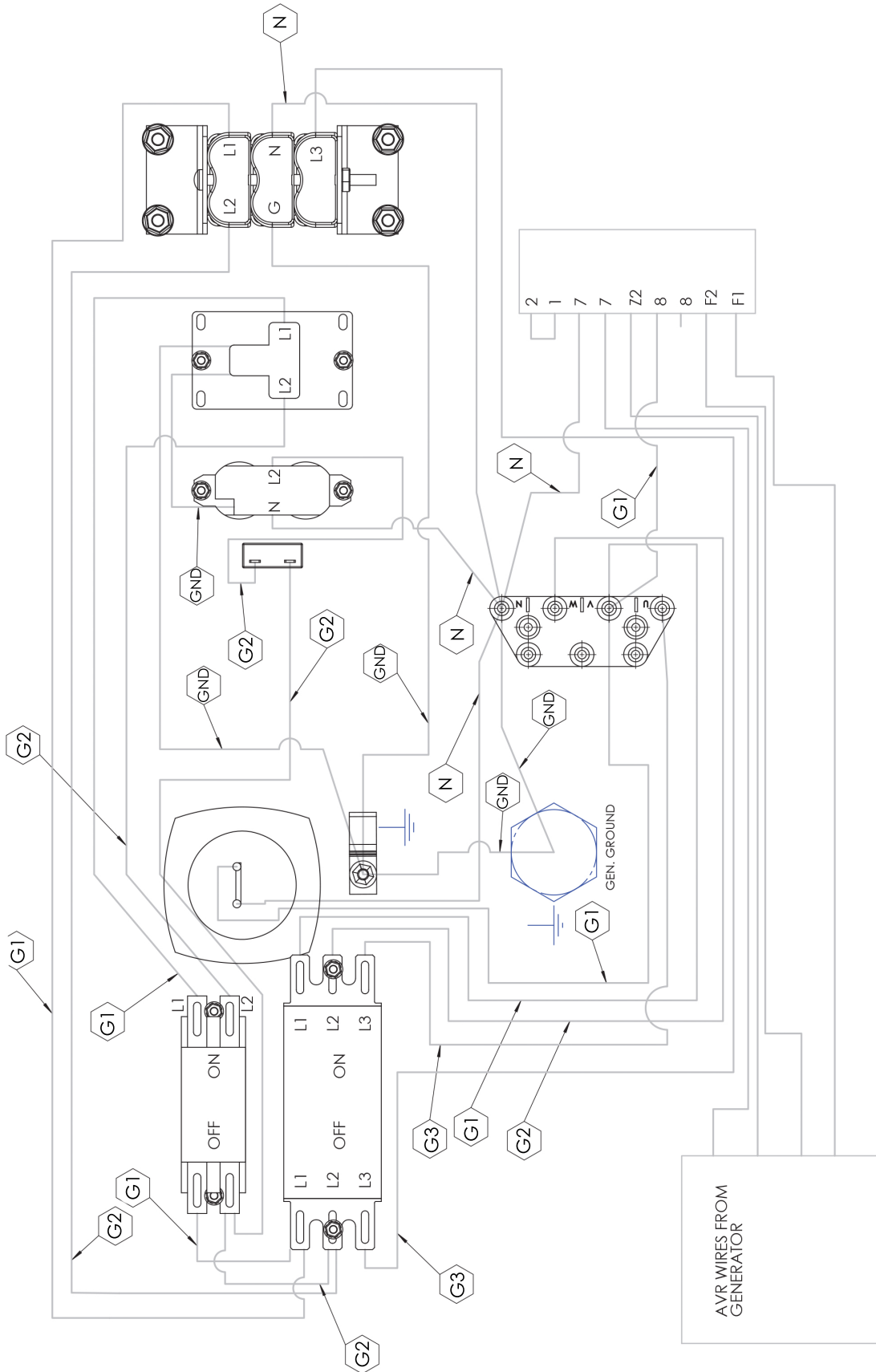

# 277/480V THREE PHASE BACK VIEW

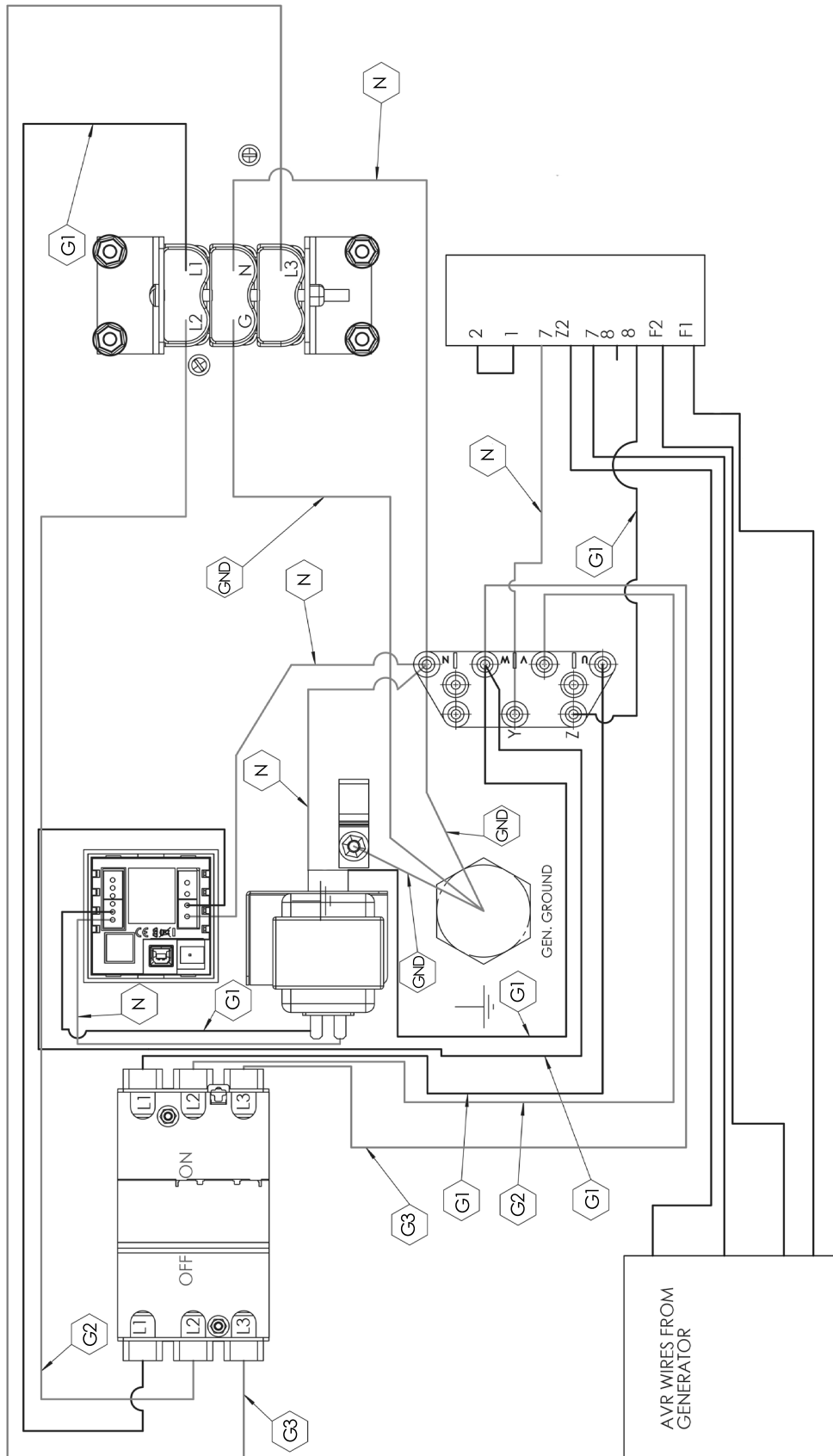

## **36 MONTH LIMITED WARRANTY**

WINCO, Inc., warrants for thirty-six months from date of shipment, that it will repair or replace at its option, for the original user, the whole or any part of the product found upon examination, by WINCO at its factory at 225 South Cordova Avenue, Le Center, Minnesota, or by any factory-authorized service station, to be defective in material or workmanship under normal standby use (average less than 50 hours per month) and service.

For warranty service, return the product within 36 months from the date of purchase, transportation charges prepaid, to your nearest factory-authorized service station or the WINCO factory. **THERE IS NO OTHER EXPRESS WARRANTY.**

There is no other express warranty. To the extent permitted by law, any and all warranties, including those of merchantability and fitness for a particular purpose, are limited to 36 months from date of shipment, and liability for incidental or consequential damages or expenses is excluded. Some states do not allow limitations on the duration of an implied warranty, and some states do not allow the exclusion or limitation of incidental or consequential damages, so that above limitation or exclusion may not apply to you. This warranty gives you specific legal rights; you may have other rights which vary from state to state. Note: Some states do not allow limitation on the duration of implied warranty and some states do not allow the exclusion or limitation of incidental or consequential damages, so the above limitations may not apply in every instance. This warranty gives you specific legal rights which may vary from state to state.

### **EXCLUSIONS:**

WINCO does not warrant drive lines, trailer tires, receptacles, or certain other component parts of the product installed by others, since such items are warranted by their manufacturers.

WINCO does not warrant modifications or alterations which were not made or authorized by the WINCO factory and which affect the stability or reliability of the product.

WINCO does not warrant products which have been exposed to misuse and/or negligence or have been involved in an accident.

WINCO does not warrant products which have been installed in such a manner as not to protect them from the adverse environmental conditions (water, mud, insects, etc.) or have not been kept clean.

WINCO reserves the right to change or improve its products without incurring any obligations to make such changes or improvements on products purchased previously.

This warranty is limited to bench labor and parts only, no allowance will be made for travel time, or removal and reinstallation of the PTO unit.