

DISCHARGE VIEW

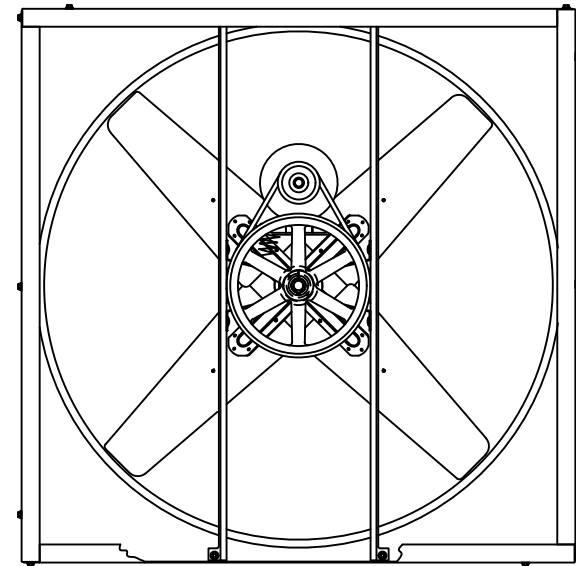
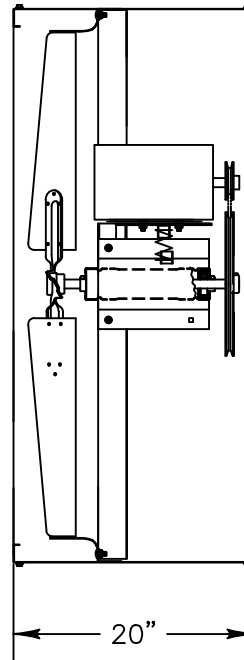

INTAKE VIEW

Exhaust Fan Specifications

Blade Diameter:	48"	Motor Enclosure:	ODP
Drive:	Belt	Duty Cycle:	Continuous Duty
Horsepower:	3/4	Guards:	N/A
Voltage:	115/230	Prewired:	115v
Phase:	1	Power Cord:	10' with molded plug
RPM:	455		

*See TriangleFans.com for performance specifications
 *Specifications are subject to change without notice



VI4814-U

NOT TO SCALE | 28 SEP 2015