

DISCHARGE VIEW

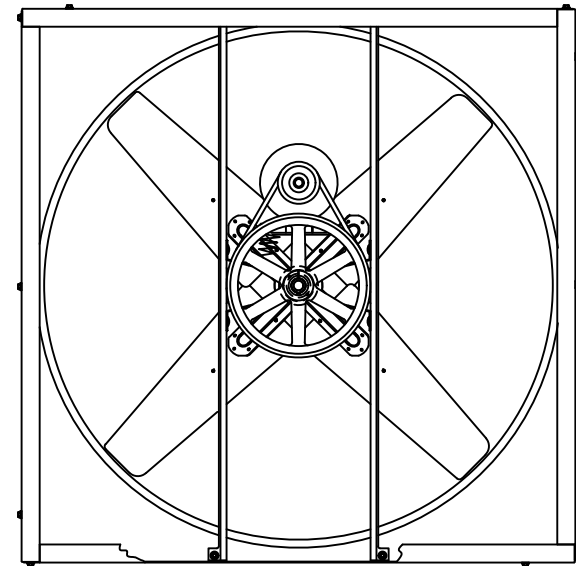

INTAKE VIEW

Exhaust Fan Specifications

Blade Diameter:	42"	Motor Enclosure:	ODP
Drive:	Belt	Duty Cycle:	Continuous Duty
Horsepower:	1	Guards:	N/A
Voltage:	115/230	Prewired:	115v
Phase:	1	Power Cord:	10' with molded plug
RPM:	475		

*See TriangleFans.com for performance specifications
 *Specifications are subject to change without notice



VI4215-U

NOT TO SCALE | 28 SEP 2015