

CHAIN PROVIDED BY CUSTOMER

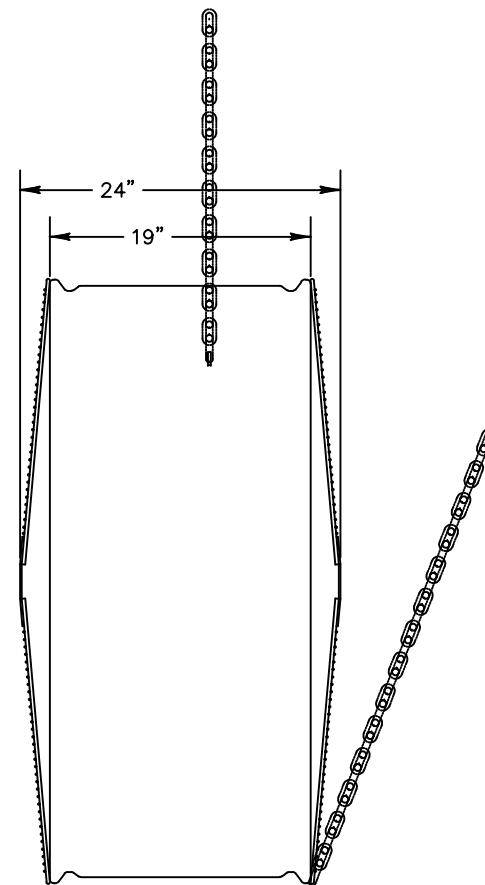

Fan Specifications

Blade Diameter:	42"	Motor Enclosure:	Hazardous Location
Drive:	Belt	Duty Cycle:	Continuous Duty
Horsepower:	1/2	Guards:	OSHA Compliant, Spiral Wound
Voltage:	230/460	Power Cord:	N/A
Phase:	3		
RPM:	500		

*See TriangleFans.com for performance specifications

*Specifications are subject to change without notice



SEB4213HL-X

NOT TO SCALE | 15 JUN 2018