

INTAKE VIEW

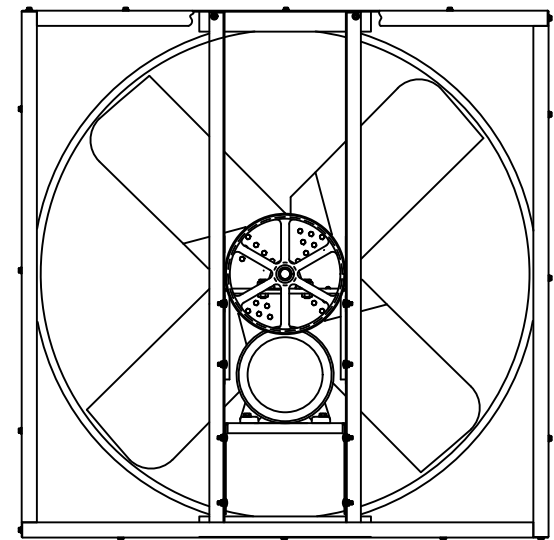
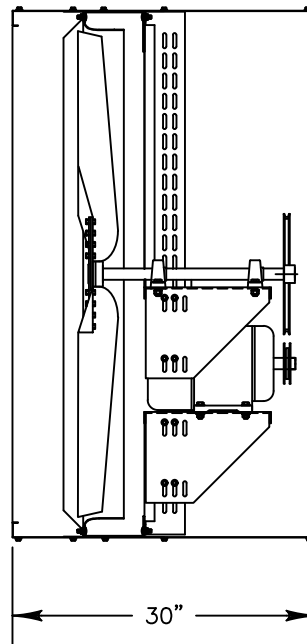

DISCHARGE VIEW

Supply Fan Specifications

Blade Diameter:	54"	Motor Enclosure:	ODP
Drive:	Belt	Duty Cycle:	Continuous Duty
Horsepower:	2	Guards:	N/A
Voltage:	115/230	Power Cord:	N/A
Phase:	1		
RPM:	615		

*See TriangleFans.com for performance specifications
 *Specifications are subject to change without notice



RVI5417-U

NOT TO SCALE | 7 OCT 2015