

INTAKE VIEW

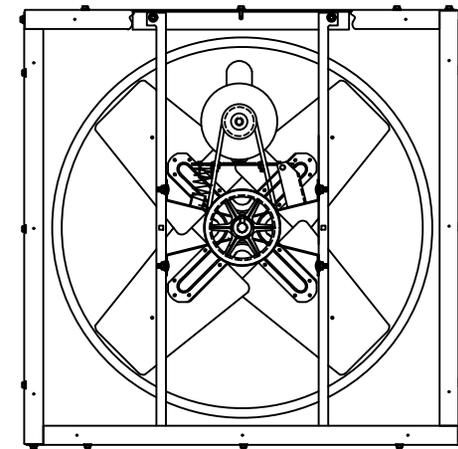
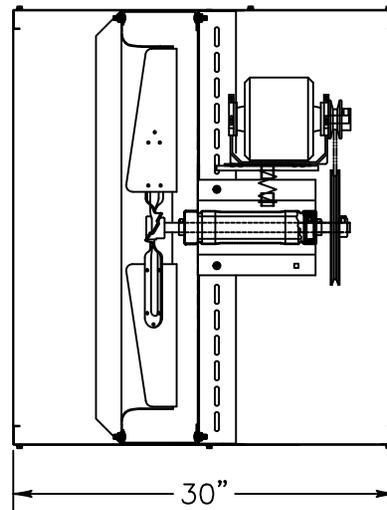

DISCHARGE VIEW

Supply Fan Specifications

Blade Diameter: 30"	Motor Enclosure: ODP
Drive: Belt	Duty Cycle: Continuous Duty
Horsepower: 1/3	Guards: N/A
Voltage: 115	Power Cord: 10' with molded plug
Phase: 1	
RPM: 615	

*See TriangleFans.com for performance specifications
 *Specifications are subject to change without notice



RVI3012-V

NOT TO SCALE | 1 OCT 2015