

# MOVINCOOL®

## OPERATION MANUAL

CLIMATE PRO® K12  
CLIMATE PRO® K18  
CLIMATE PRO® K24

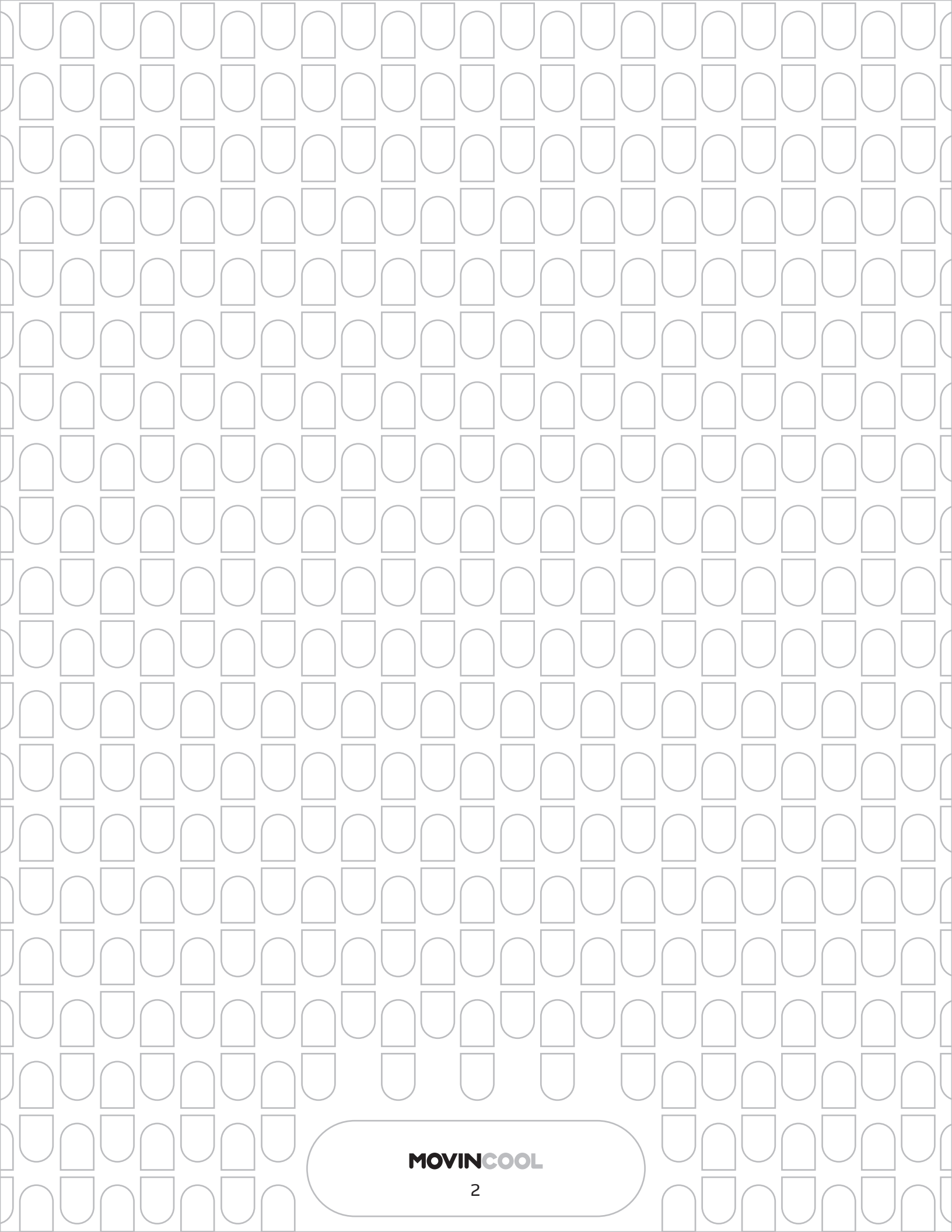

**MOVINCOOL**

# SERIAL NUMBER LOCATION

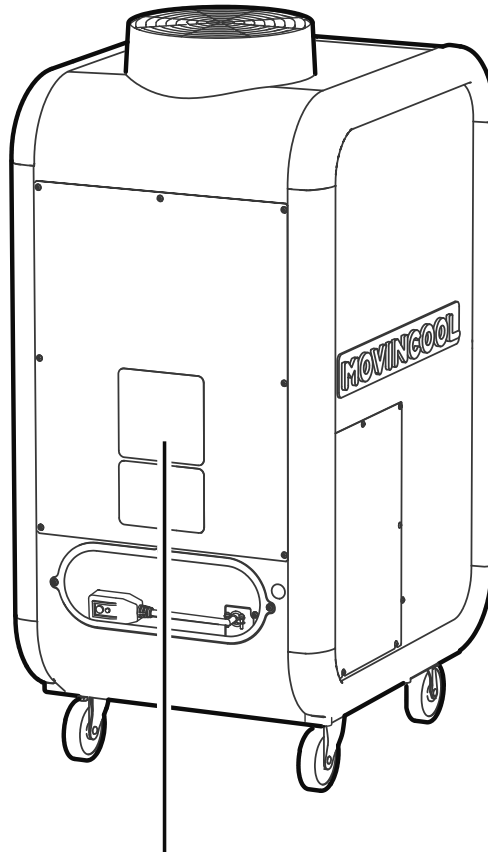

00 00 0000 000

Month Year Sequential Model  
number name

**Please read this manual carefully and keep it for future reference.**

La versión en español está disponible en [www.movincool.com](http://www.movincool.com)

La version française est disponible sur [www.movincool.com](http://www.movincool.com)

© 2020 DENSO PRODUCTS AND SERVICES AMERICAS, INC. All rights reserved.  
MovinCool® and Climate Pro® are registered trademarks of DENSO Corporation.

**MOVINCool**

# TABLE OF CONTENTS

<b>SERIAL NUMBER LOCATION</b>	3
<b>SAFETY PRECAUTIONS</b>	6
<b>NAMES OF PARTS</b>	10
<b>CONTROL PANEL</b>	12
Overview	12
Home Screen	13
Mode Screen	14
Menu Screen	15
Setting Screen	16
<b>INSTALLATION</b>	17
Placement of the Unit	17
Accessories	18
Typical Installation Options	19
Plugging in the Unit	20
LCDI (Leakage Current Detection Interrupter) Power Cord	21
External Warning Device Connection	22
External Alarm Device Connection	24
<b>INITIAL SETTINGS</b>	26
Privacy Disclosure Screen	26
Selecting Time Zone	27
Setting Daylight Savings	30
Clock Setting	32
Removing Securing Tapes and Sheet	35
<b>OPERATION</b>	36
Cool Mode	36
Fan Only Mode	38
Schedule Mode	40
Starting Schedule Mode Operation	41
Stopping Schedule Mode Operation	43
Temporary Stop During Schedule Mode	44
Setting / Editing / Viewing Schedule	45
Clearing Schedule	48



Adjusting Brightness	50
Fan Mode	52
Changing Temperature Scale	54
Key Lock	56
Key Unlock	57
Temporary Stop During Key Lock	58
Service Information	59
Self-Diagnostic Codes	62
List of Self-Diagnostic Codes	63
Emptying the Drain Tank	64
Condensate Pump Kit (Optional Accessory)	65
<b>MAINTENANCE</b>	<b>66</b>
Cleaning Air Filters	66
Cleaning the Unit	67
Before Long Term Storage	67
<b>TECHNICAL SPECIFICATIONS</b>	<b>68</b>
<b>TROUBLESHOOTING</b>	<b>70</b>
<b>WARRANTY STATEMENT</b>	<b>71</b>
<b>DATA PRIVACY DISCLOSURE</b>	<b>72</b>

# SAFETY PRECAUTIONS

This appliance is not intended for use by persons (including children) with reduced physical, sensory or mental capabilities, or lack of experience and knowledge, unless they have been given supervision or instruction. Children should be supervised to ensure that they do not play with the appliance.

To reduce the risk of injury or property damage, read "Safety Precautions" carefully before operating the appliance.

The seriousness is classified by the following indicators:

 <b>WARNING</b>	Indicates a hazardous situation which, if not avoided, could result in death or serious injury.
 <b>CAUTION</b>	Indicates a hazardous situation which, if not avoided, could result in minor or moderate injury, damage to the unit or its components and/or property.







- Serious injuries include: loss of vision, bodily injuries, burns, electric shock, fractures or poisoning, which require prolonged medical treatment and will leave after-effects.
- Minor or moderate injuries include: bodily injuries, burns or electric shock, which do not require prolonged medical treatment.
- Property includes: housing, household goods, livestock or pets.





## Safety symbols and meanings

 This must not be done.	 This must be done.	 Ensure unit is grounded.
--	--	--





 **WARNING**

## OPERATION



	<b>Do not touch electrical parts or switch button with wet or oily hands.</b> This may cause fire, electric shock or malfunction.
	<b>Do not put a finger, a rod or other objects into the air outlet or inlet.</b> Touching fan or heat exchanger may result in injury or malfunction.
	<b>Do not place or use flammable spray near the unit.</b> This may cause explosion or fire.
	<b>Do not use the unit in an environment which contains excessive amounts of flammable gas, conductive dust or oil.</b> This may cause explosion or fire.
	<b>Do not use the unit in an environment which contains corrosive gas or vapor.</b> This may deteriorate the insulation and result in electric shock or fire. This may corrode pipes and result in leaks.
	<b>Do not wash the unit with water.</b> This may cause fire, electric shock or malfunction.

	<b>Do not point the airflow directly on your body for long periods of time or make your body too cold.</b> This may result in health problems.
	<b>Do not use an extension cord or multi-socket plug.</b> This may generate heat and cause a fire or electric shock.
	<b>Do not use damaged power cord/plug or modify the cord/plug.</b> This may generate heat and cause a fire or electric shock.
	<b>Do not heat, pull, wind, bundle or place heavy objects on the power cord.</b> This may generate heat and cause a fire or electric shock.
	<b>If an abnormality such as a burning smell occurs, stop the operation and turn the breaker OFF.</b> This may cause fire, electric shock or malfunction. Stop the operation immediately and consult your MovinCool dealer or qualified technician.

## INSTALLATION













	<b>Do not install the unit in a place where flammable gas may generate, flow, gather or leak. Do not install the unit in a place where conductive dust or oil is floating.</b> This may cause explosion or fire.
	<b>Installation and electrical work must be performed in accordance with national wiring regulations by qualified electrical personnel.</b> Improper installation or electrical work may cause fire, electric shock, injury, malfunction or water leaks.
	<b>Install an earth leakage circuit breaker to the mains power source.</b> Improper installation or electrical work may cause fire, electric shock, injury, malfunction or water leaks.
	<b>Use only official accessories and consult your MovinCool dealer or qualified technician for installing the accessories to the unit.</b> Non-genuine accessories or incomplete installation may cause fire, electric shock or water leaks.
	<b>Ensure effective grounding.</b> Incomplete grounding may result in fire or electric shock. Contact your MovinCool dealer or qualified technician.

## RELOCATION/REPAIR







	<b>Do not repair, disassemble or modify the unit yourself.</b> This may cause fire, electric shock, injury, water leaks or malfunction. Contact your MovinCool dealer or qualified technician.
	<b>If the unit is soaked due to natural disaster, consult your MovinCool dealer.</b> If you keep using the unit, it may result in fire, electric shock or malfunction.

 **CAUTION**





## OPERATION

	<p><b>Do not operate without panels or fan guards.</b> Touching high-voltage, high-temperature or rotating parts may cause electric shock, injury or burns.</p>
	<p><b>Do not use the unit in sloping, non-level areas.</b> Use the unit only on a smooth, flat, level surface. There is a risk of electric shock due to water leaks or injury due to toppling.</p>
	<p><b>Do not operate the unit without air filters.</b> Touching the heat exchanger may cause injury. If dust or dirt enters the unit, it may result in malfunction or poor operation of the unit.</p>
	<p><b>Do not tilt the unit while moving to another place.</b> This may cause injury due to toppling or property damage due to water leaks from the unit.</p>
	<p><b>Do not press the control buttons with a sharp-pointed object such as a ballpoint pen or a fingernail.</b> This may cause electric shock or malfunction.</p>
	<p><b>Do not sit, stand or place objects on top of the unit.</b> This may cause injury due to toppling or falling.</p>
	<p><b>Do not place water containers on the unit.</b> If the containers fall over, water spilling into the unit may cause electric shock or malfunction.</p>
	<p><b>Do not expose combustion appliances to the direct air flow.</b> This may cause incomplete combustion.</p>
	<p><b>Do not expose animals or plants to the direct air flow.</b> This may have negative effects on plants and animals.</p>
	<p><b>Do not use the unit to preserve food, plants, animals, precision devices, or works of art.</b> This may have negative effects on the quality of objects.</p>
	<p><b>Ensure adequate ventilation when operating with combustion appliances.</b> Poor ventilation may cause headaches due to lack of oxygen.</p>
	<p><b>Lock the caster while operating.</b> Failure to lock casters may cause injury due to moving or falling.</p>



	<b>Unlock the caster to move the unit.</b> Failure to unlock the caster may cause injury due to falling.
	<b>When the tank is full, empty water immediately.</b> Water leaks from the unit may cause property damage, or injury due to wet floor.
	<b>Never pull the power cord to disconnect the unit from the outlet. Grasp the plug directly and pull it from the outlet.</b> This may cause generation of heat or fire due to cord damage.
	<b>When cleaning, wipe the external surface with either a dry cloth or a cloth dampened in a mild cleaner.</b> If you use organic solvent such as benzene or thinner, it may cause a crack or a scratch. This may result in electric shock or injury.
	<b>When cleaning, stop the operation and remove the power plug from the outlet.</b> If you touch high-voltage or rotating parts, it may cause electric shock or injury.
	<b>When not using the unit for a long period of time, disconnect the power plug.</b> Failure to disconnect the power plug may cause generation of heat or fire due to accumulated dust.

## INSTALLATION

	<b>Do not install the unit on ships, in vehicles or locations subject to vibration.</b> Improper installation may cause injury, refrigerant leaks, water leaks or malfunction.
	<b>Do not expose the unit to rain or an environment where it may be exposed to excess water.</b> This may cause electric shock or leakage.
	<b>Install the unit in a place which is strong enough to withstand the weight of the unit.</b> Improper installation may cause injury or the unit damage due to falling.
	<b>Install spark guards if the unit is installed in area where sparks are present.</b> Improper installation may cause fire or water leaks.

# NAMES OF PARTS

- A** Condenser Air Outlet Flange
- B** Control Panel
- C** Cold Air Outlet Grill
- D** Service Panel
- E** Caster
- F** Power Cord
- G** Power Cord Holder

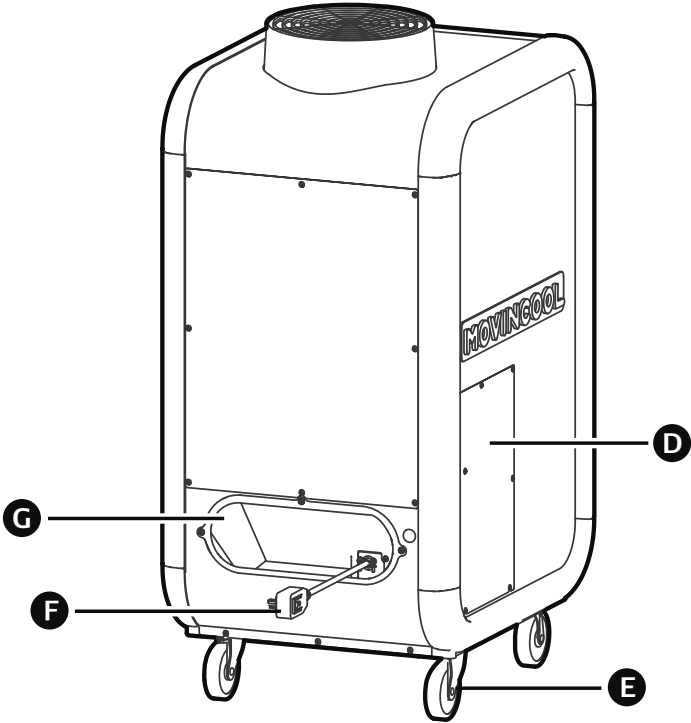
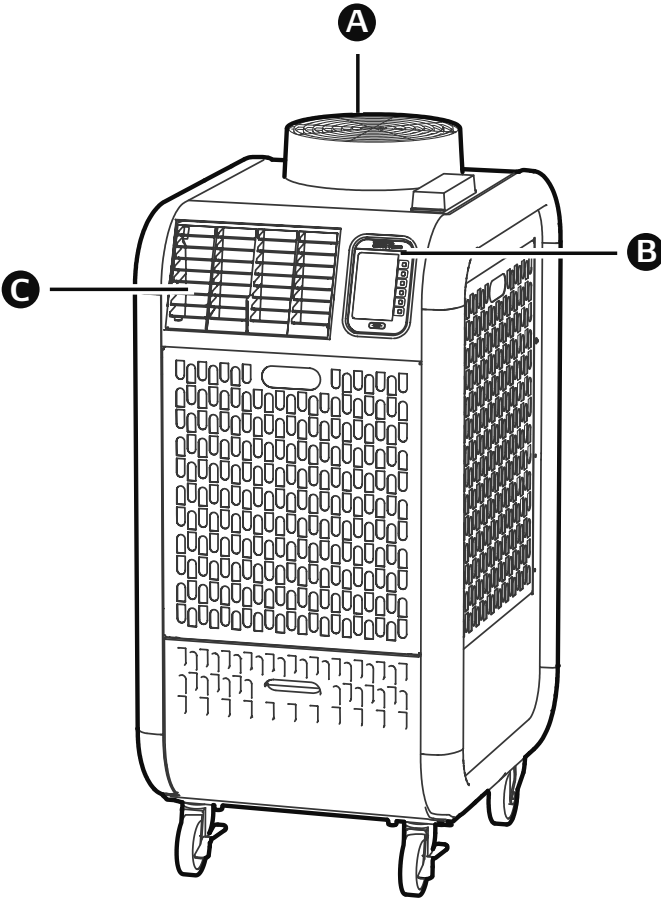

# NAMES OF PARTS

- H** Condenser Filter
- I** Side Panel
- J** Drain Tank
- K** Drain Tank Cover
- L** Front Panel
- M** Evaporator Filter

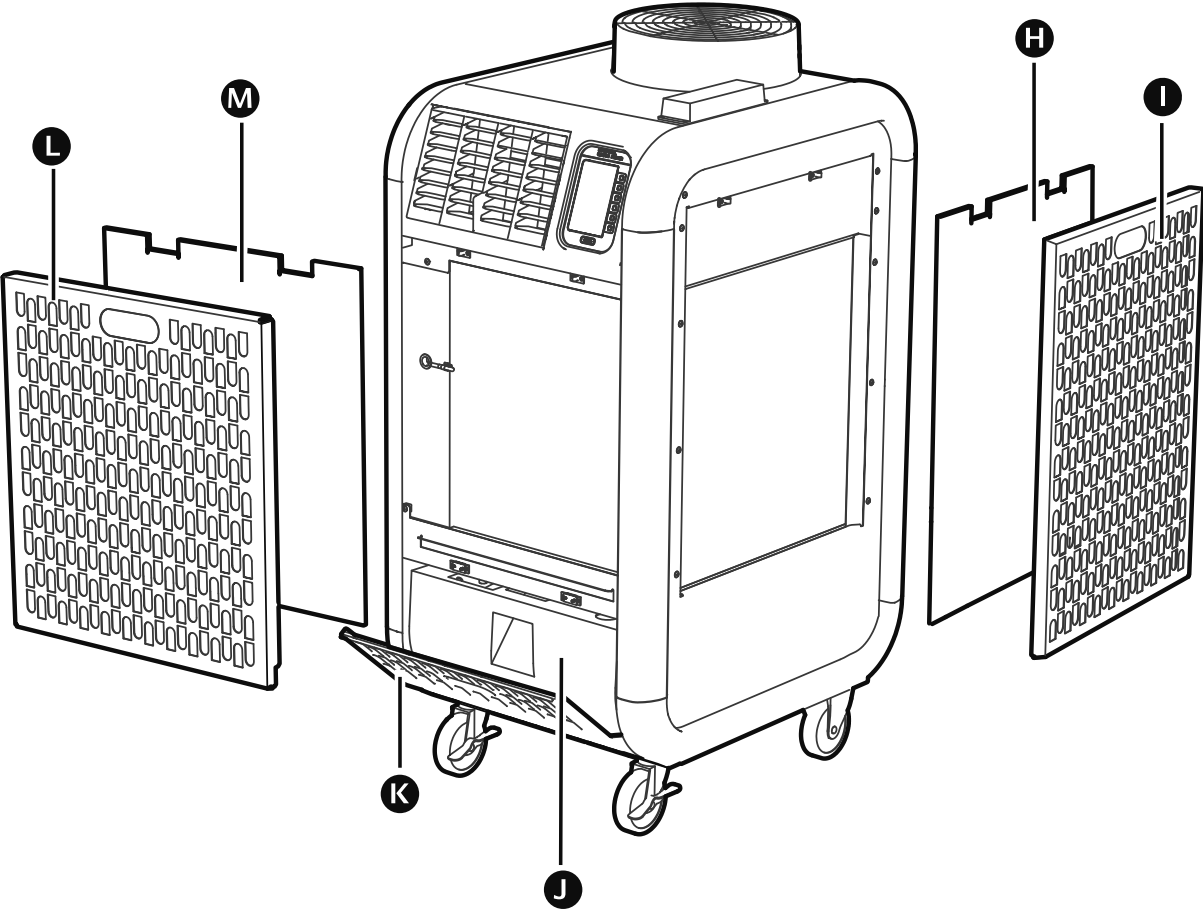

# CONTROL PANEL

## OVERVIEW

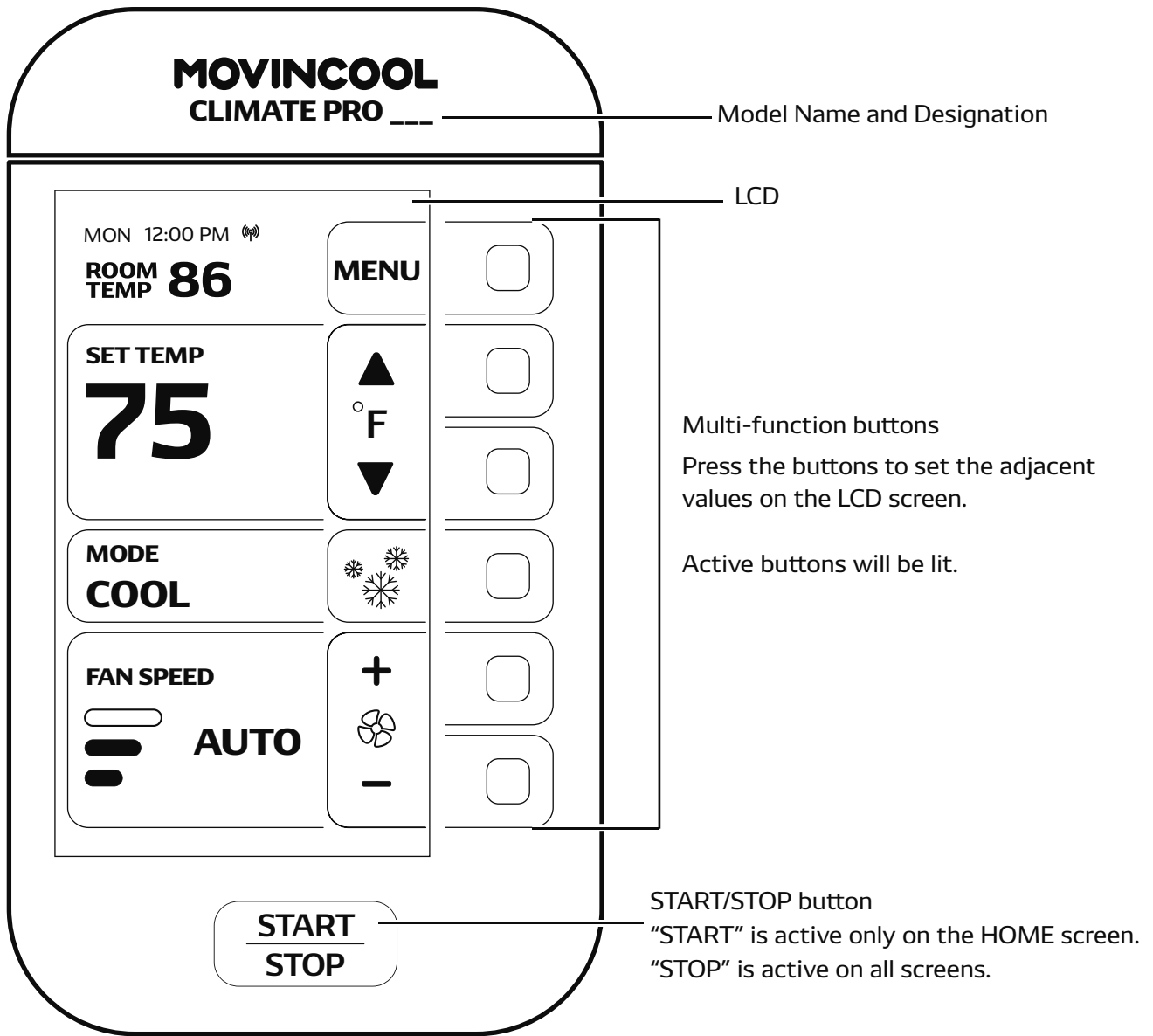

# HOME SCREEN

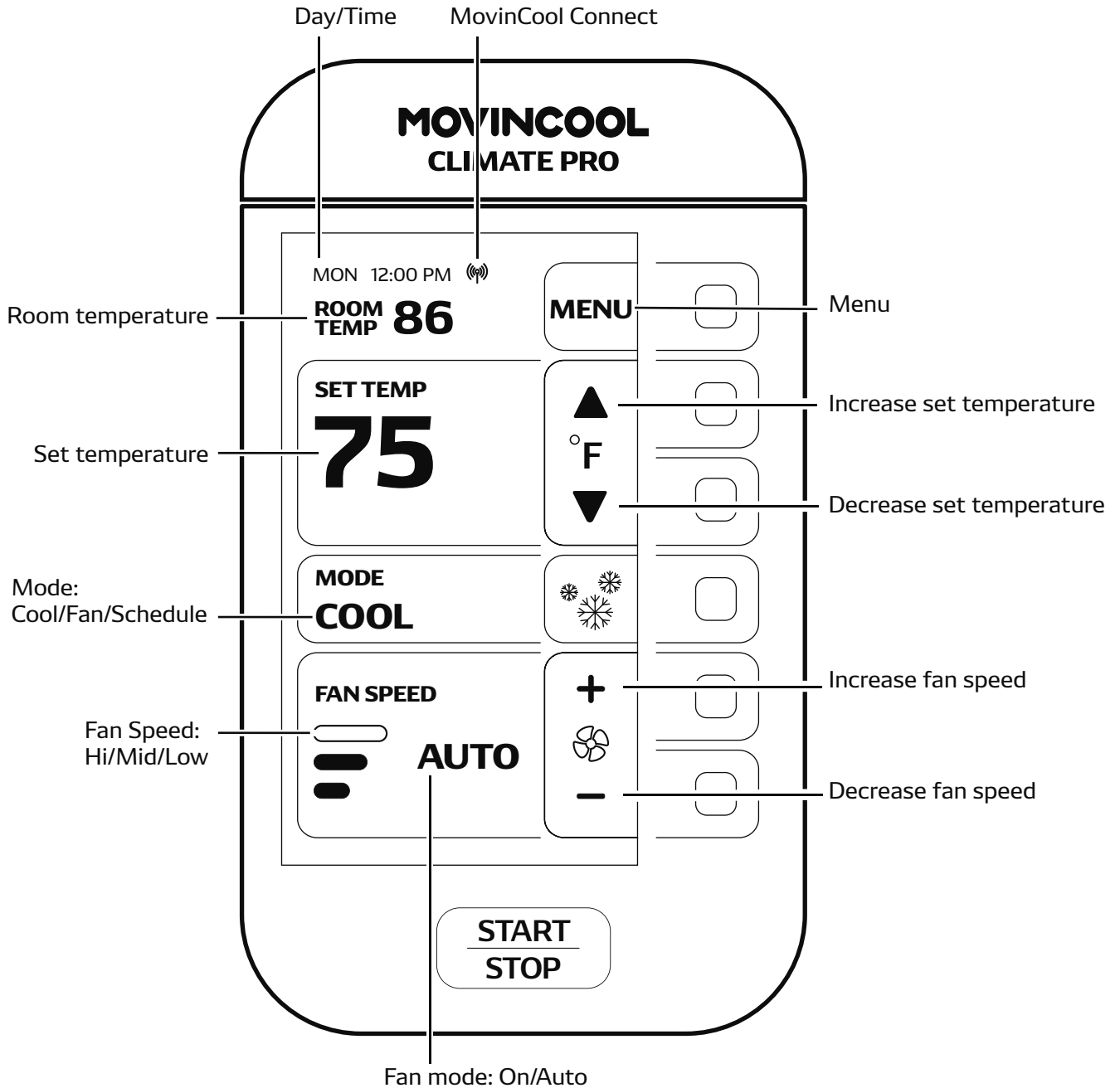

**Note:**

- If no button is pressed for 15 minutes, the screen saver appears. Press any button to return to the HOME screen.

# MODE SCREEN

HOME > MODE

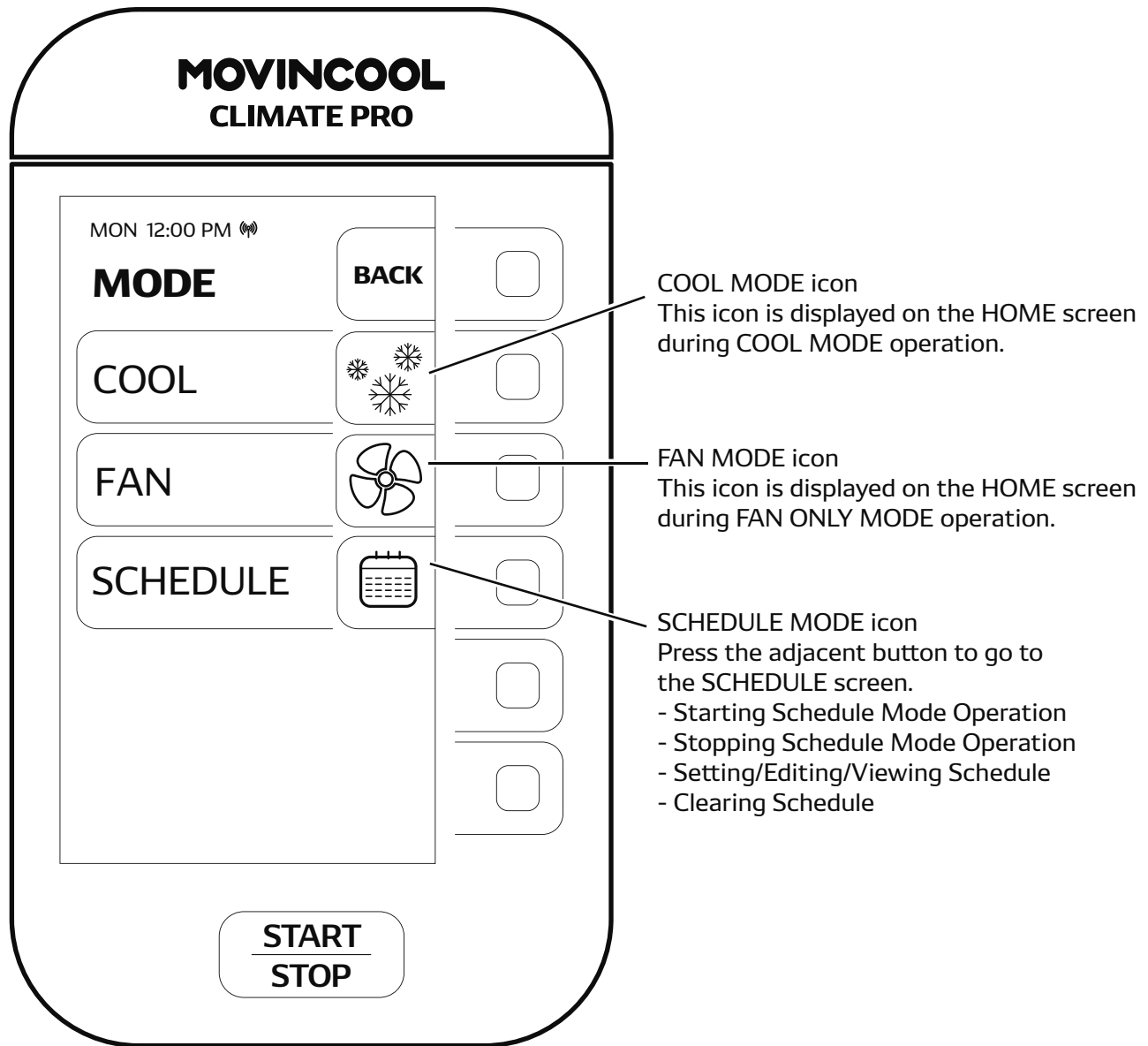

Note:

- If no button is pressed for 30 seconds, the screen automatically returns to the HOME screen.

# MENU SCREEN

HOME > MENU

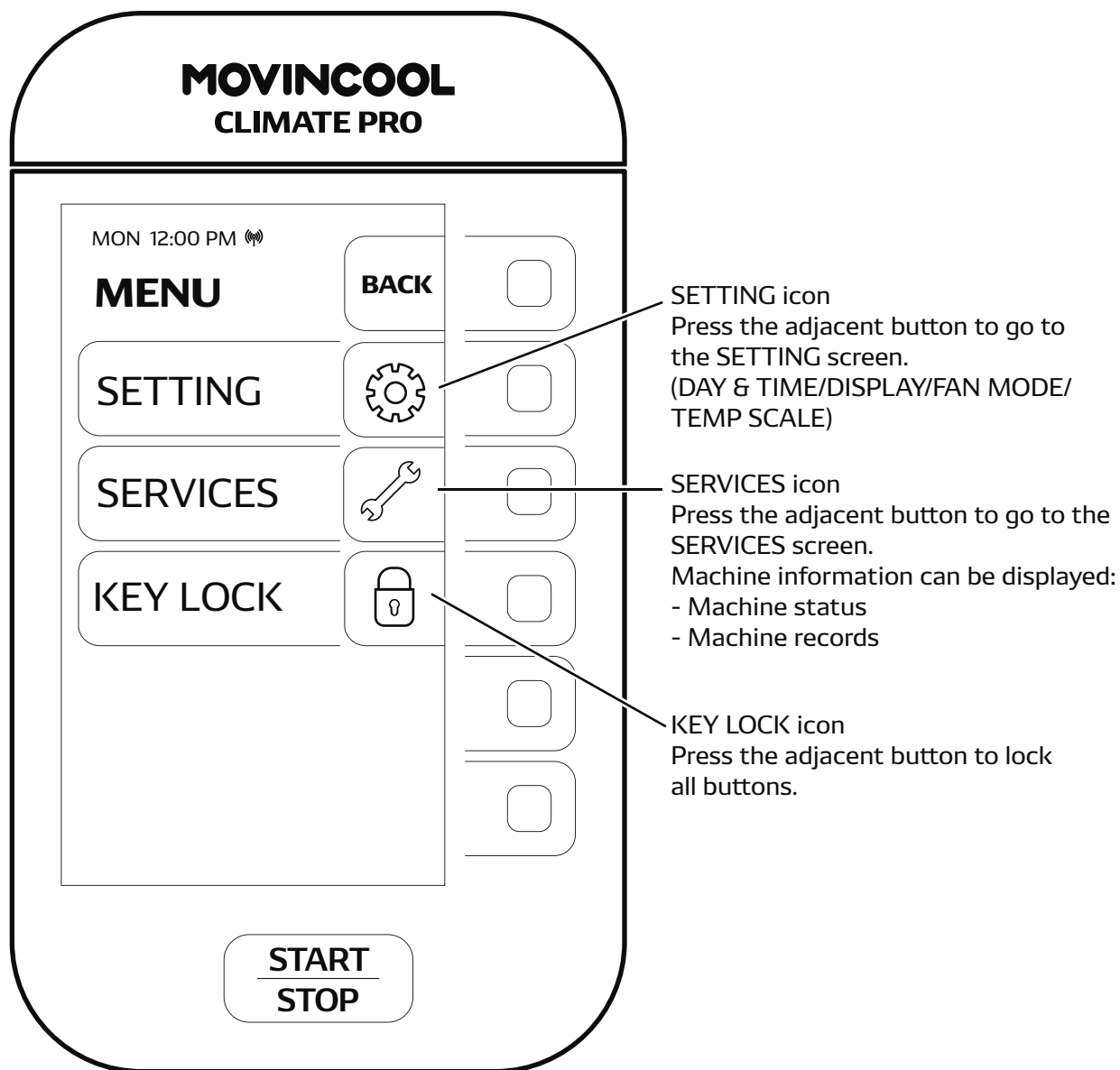

Note:

- If no button is pressed for 30 seconds, the screen automatically returns to the HOME screen.

# SETTING SCREEN

HOME > MENU > SETTING

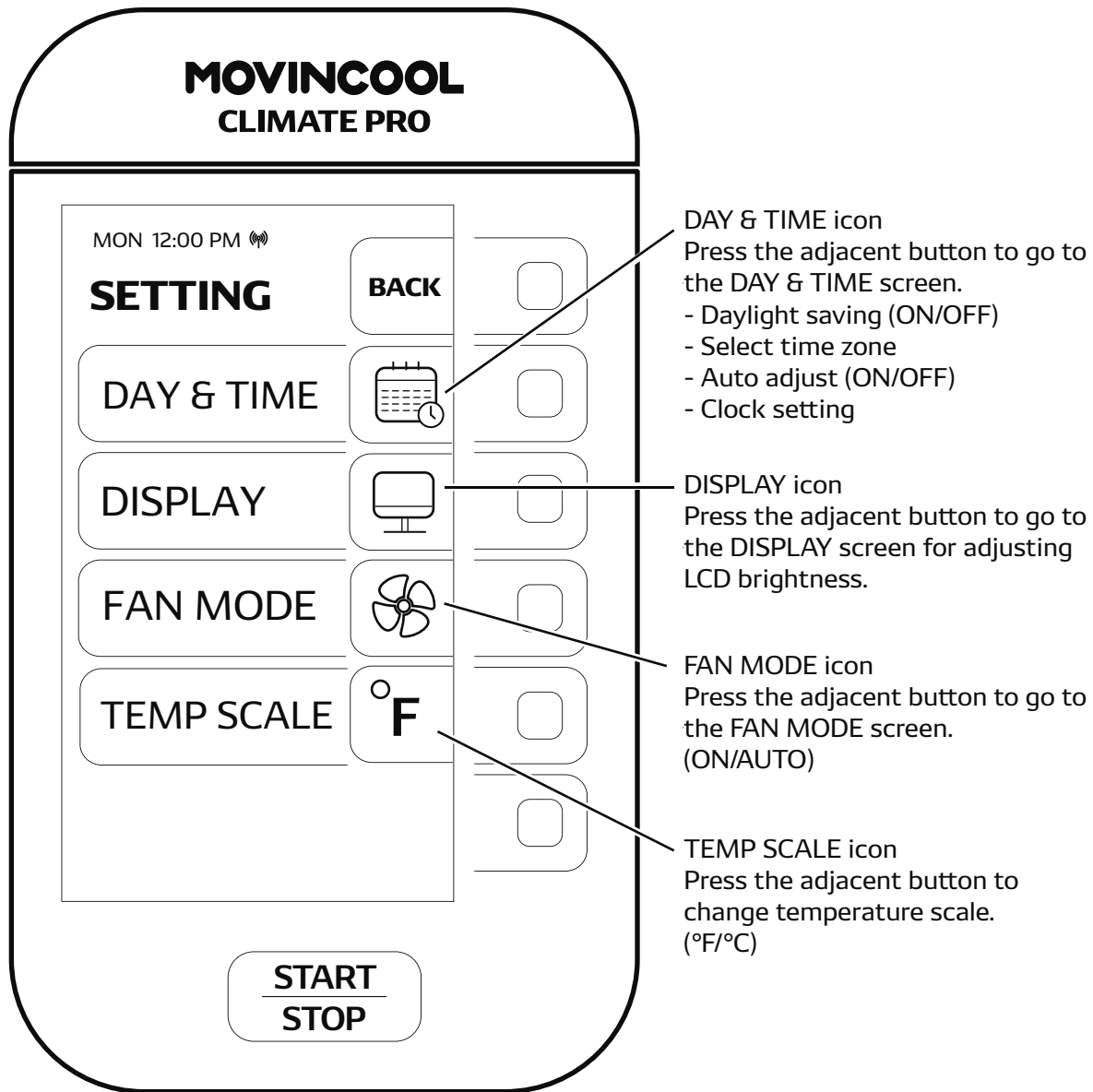

## Note:

- TEMP SCALE is only displayed while the unit is idle.
- If no button is pressed for 30 seconds, the screen automatically returns to the HOME screen.



# INSTALLATION

## PLACEMENT OF THE UNIT

### WARNING

- Installation and electrical work must be performed by qualified electrical personnel. Incorrect installation and/or electrical work may cause fire, electric shock, injury, malfunction or water leaks.
  - To avoid explosion or fire:
  - Do not install the unit in a place where flammable gas may generate, flow, gather or leak.
  - Do not install the unit in a place where conductive dust or oil is floating.
1. Unlock the casters and move the unit to a flat, level surface and then set the casters back to the locked position.

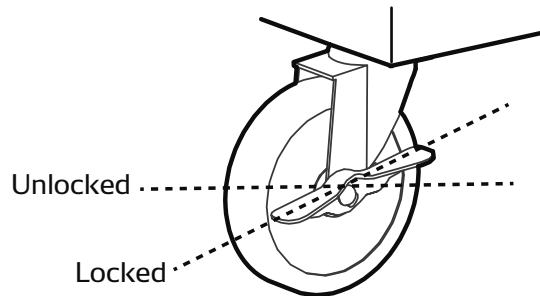

2. Ensure the air inlets and outlets are not blocked. Keep a minimum clearance of 18 inches (457 mm) from walls or other objects.
3. Unit weight table for 3 models

MODEL	UNIT WEIGHT *1
Climate Pro K12	199 lb (90 kg)
Climate Pro K18	205 lb (93 kg)
Climate Pro K24	238 lb (108 kg)

\*1 Approximate weight when the drain tank is full of water

### CAUTION

- Install the unit in a place which is strong enough to withstand the weight of the unit. Incorrect installation may cause injury or the unit damage due to falling.

# ACCESSORIES

- A** Nozzle Adapter Kit
- B** Nozzle Kit
- C** Cold Air Flange Kit
- D** Cold Air Extension Duct
- E** Trim Ring
- F** Self-Supported Duct
- G** Ceiling Tile
- H** Condenser Air Plenum
- I** Condensate Pump Kit

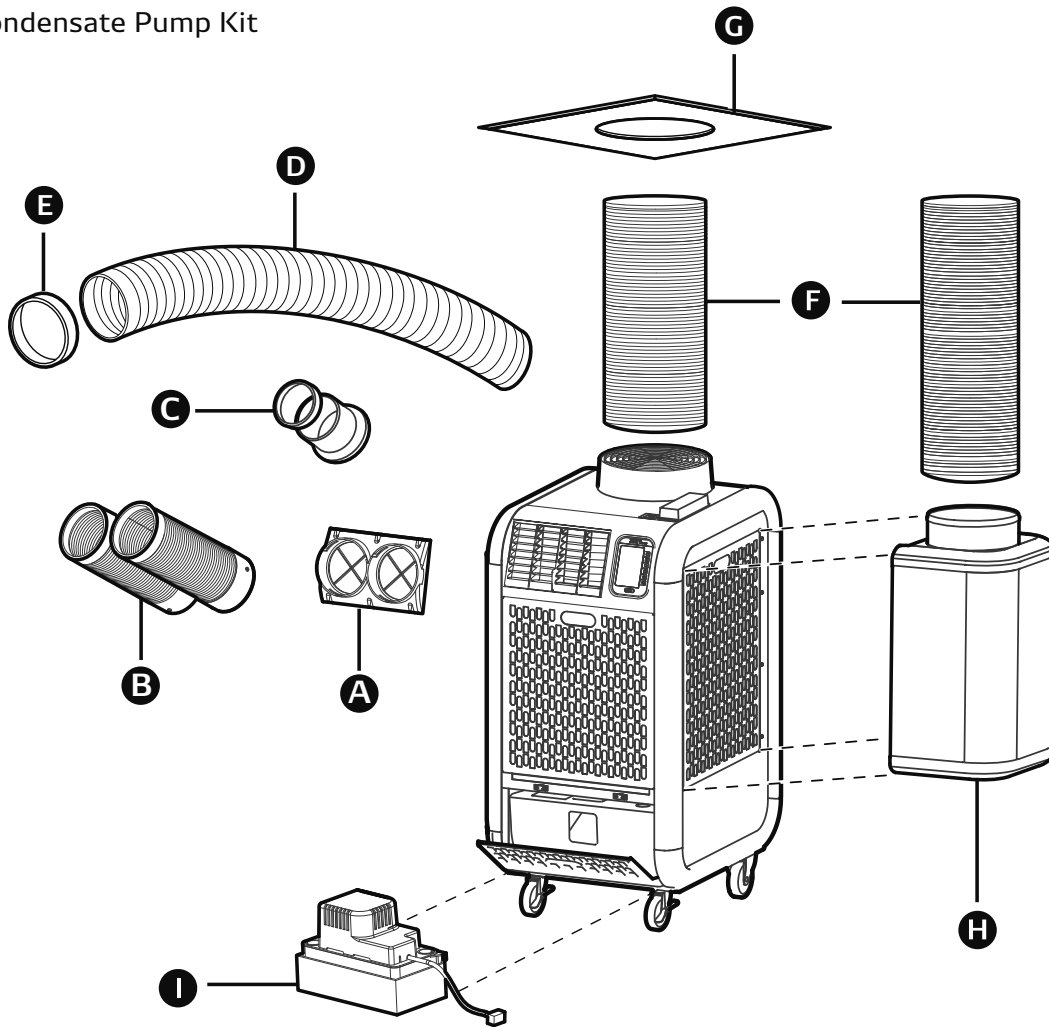

## WARNING

- Use only official accessories and consult your MovinCool dealer or qualified technician for installing accessories to the unit. Non-genuine accessories or incomplete installation may cause fire, electric shock or water leaks.

## TYPICAL INSTALLATION OPTIONS

### Option 1:

No negative air pressure in the room

Operating condition: 65°F (18°C), 50%RH to 95°F (35°C), 60%RH

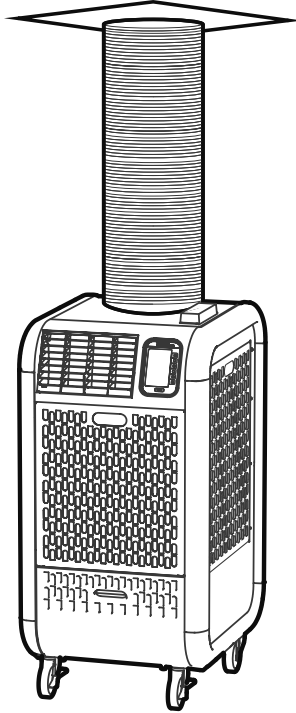

### Option 2:

Negative air pressure in the room

Operating condition: 65°F (18°C), 50% to 95°F (35°C), 60%RH

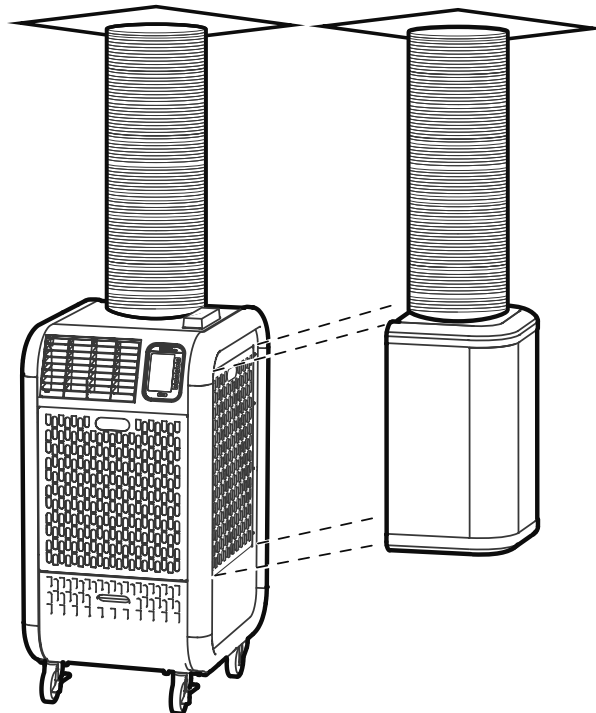

# PLUGGING IN THE UNIT

## WARNING

- Insert the power plug properly into the outlet. Incomplete insertion may cause fire or electric shock.  
  
To avoid fire, electric shock or malfunction:
  - Do not connect or disconnect the power plug with wet or oily hands.
  - Do not turn the unit on or off by connecting or disconnecting the power plug.
  
- To avoid generation of heat, fire or electric shock:
  - Do not use an extension cord or multi-socket plug.
  - Do not heat, pull, wind, bundle or place heavy objects on the power cord.
  - Do not use damaged power cord/plug or modify the cord/plug.
  
- Qualified personnel must replace the damaged power cords with one of the same LCDI (Leakage Current Detection Interrupter) cord, obtainable from the AC manufacturer. Incorrect replacements may cause fire, electric shock, injury or malfunction.
  
- Always use fuses with correct capacity. Using copper or other wire may result in fire or malfunction.

Check the power supply outlet rating, recommended fuse size, and NEMA plug configuration below.

MODEL	MINIMUM POWER SUPPLY RATING	RECOMMENDED FUSE SIZE	NEMA PLUG CONFIGURATION
Climate Pro K12	115V, 1 phase, 60 Hz, 15A	15A maximum	5-15
Climate Pro K18	115V, 1 phase, 60 Hz, 20A	20A maximum	5-20
Climate Pro K24	208/230V, 1 phase, 60 Hz, 20A	20A maximum	6-20

# LCDI (Leakage Current Detection Interrupter) POWER CORD

The unit is equipped with LCDI to monitor leakage current. Read the instructions printed on the device for proper use and handling. The conductors inside the cord are surrounded by shields, which are not grounded. Check the cord for damage regularly. If the device trips, find the cause and correct the fault before operating the unit.

## WARNING

To avoid fire, electric shock or malfunction:

- Do not attempt to open the device.
- Do not immerse in water.
- Do not remove the ground prong.
- Do not use the device beyond the recommended voltage.
- Do not use the device if the shields become exposed.
- Do not repeatedly push TEST and/or RESET buttons.

Note:

- The LCDI is a non-serviceable device. Damage caused by attempting to do the repair yourself will void the warranty.

## TEST PROCEDURE

Follow the instructions to ensure that LCDI power cord works properly.

1. Plug the power cord into a grounded power outlet.
2. If the green power light is not on, press RESET button once.  
The light should come on.
3. Press TEST button once, the power light should go off.
4. Press RESET button once again for use. The power light should come on.
5. If this test fails, do not use this device. Contact a qualified technician.

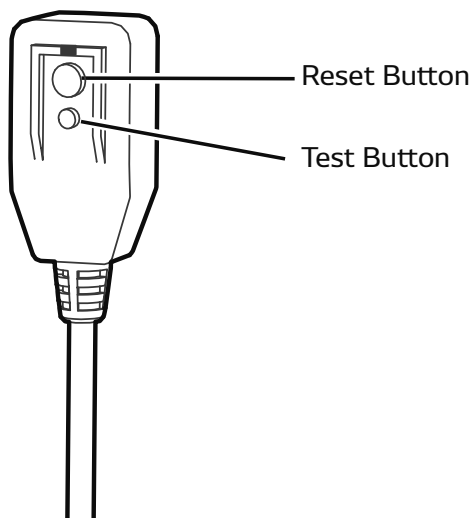

# EXTERNAL WARNING DEVICE CONNECTION

The controller has a warning signal output relay which can indicate failure of the unit with external warning devices such as alarm speaker or light indicators.

Relay type: Form C, normal open dry contact

Relay output contactor rating: 2 A at 30 V (DC/AC) or less (resistive load)

## WARNING

- Installation and electrical work must be performed in accordance with national wiring regulations by qualified personnel. Incorrect installation may cause fire, electric shock, injury, malfunction or water leaks.
- Disconnect power before installation. Beware that some residual voltage may remain in the unit after the power is disconnected. There is a risk of electric shock.

1. Turn the unit off and unplug the power cord.
2. Loosen the bottom two (2) screws and take out the other seven (7) screws. Move the service panel upward and remove it from the side of the unit.

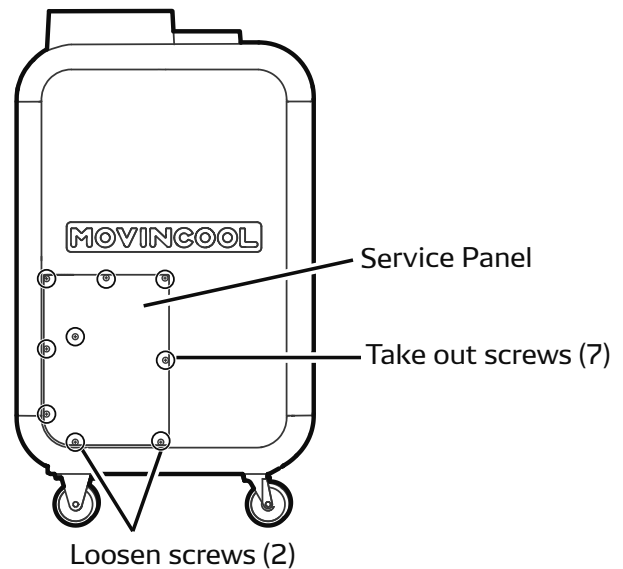

3. Loosen the center bottom screw and take out the other seven (7) screws. Move the upper rear panel upward and remove it.
4. Squeeze the inner latch and push out the cap from inside the lower rear panel.

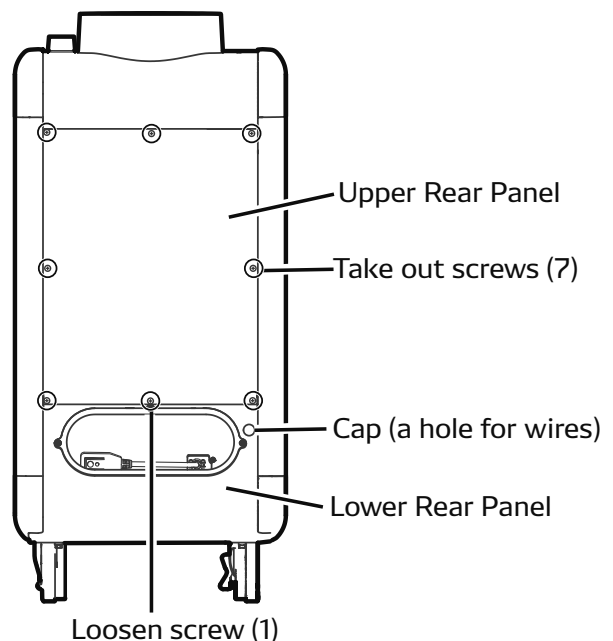

# EXTERNAL WARNING DEVICE CONNECTION

5. Insert the warning signal wires through the hole in the rear panel and then through the hole in the control box.  
Recommended wire size: 16 AWG - 22 AWG

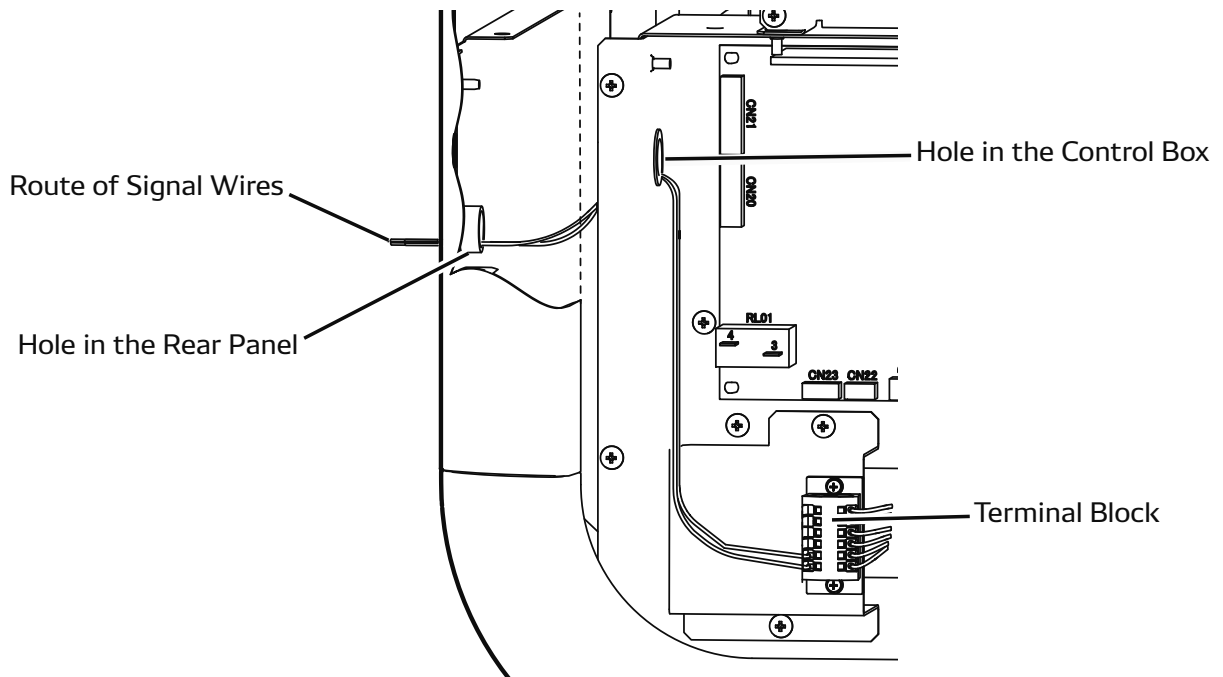

6. Connect the warning signal wires to the terminals OS-1 and OS-2 as shown in the figure.

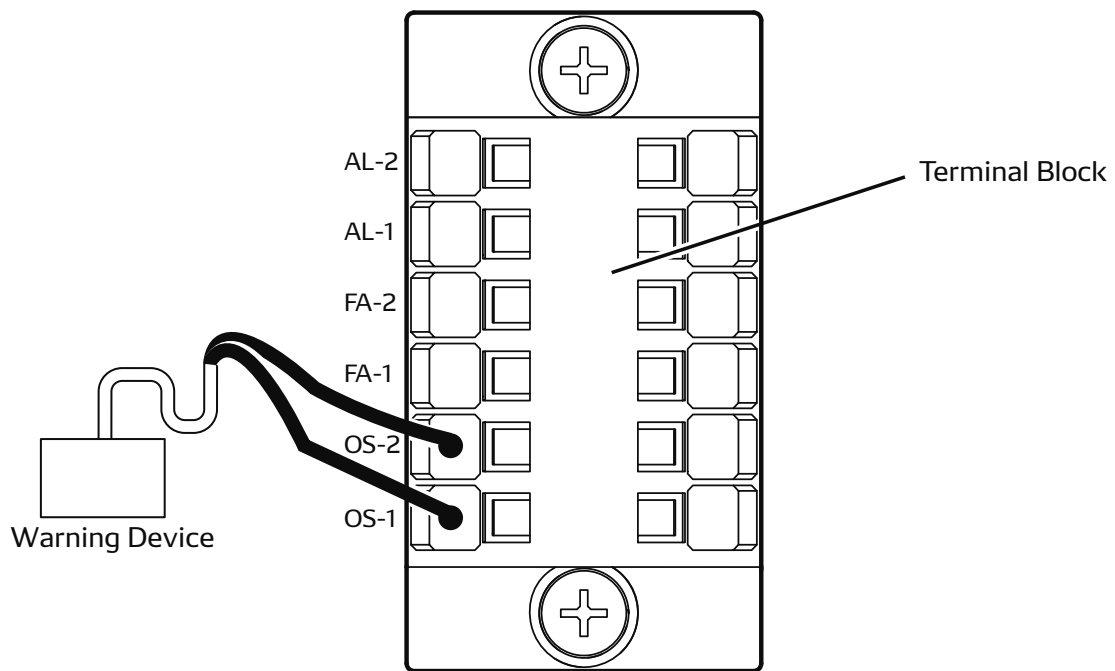

7. Reinstall the panels.

# EXTERNAL ALARM DEVICE CONNECTION

The terminal block has two sets of input signal terminals for external alarm devices such as a fire alarm. The terminals should only be connected to a closed or an open dry contact. When receiving the signals from the external alarm devices, the unit turns itself off and cannot be turned back on until it has been reset.

## WARNING

- **Installation and electrical work must be performed in accordance with national wiring regulations by qualified personnel. Incorrect installation may cause fire, electric shock, injury, malfunction or water leaks.**
- **Disconnect power before installation. Beware that some residual voltage may remain in the unit after the power is disconnected. There is a risk of electric shock.**

1. Turn the unit off and unplug the power cord.
2. Loosen the bottom two (2) screws and take out the other seven (7) screws. Move the service panel upward and remove it from the side of the unit.

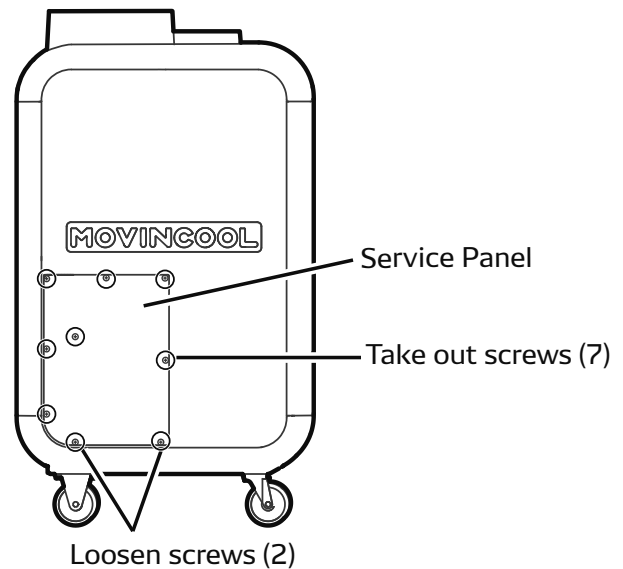

3. Loosen the center bottom screw and take out the other seven (7) screws. Move the upper rear panel upward and remove it.
4. Squeeze the inner latch and push out the cap from inside the lower rear panel.

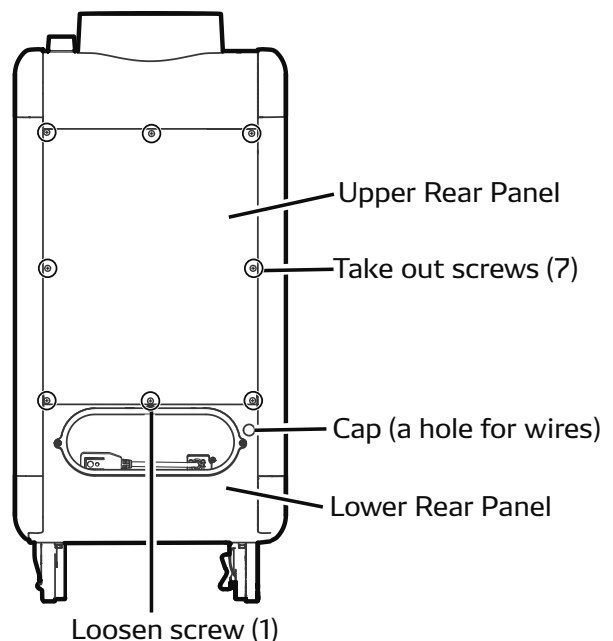



# EXTERNAL ALARM DEVICE CONNECTION

- 5. Insert the alarm signal wires through the hole in the rear panel and then through the hole in the control box.  
Recommended wire size: 16 AWG - 22 AWG

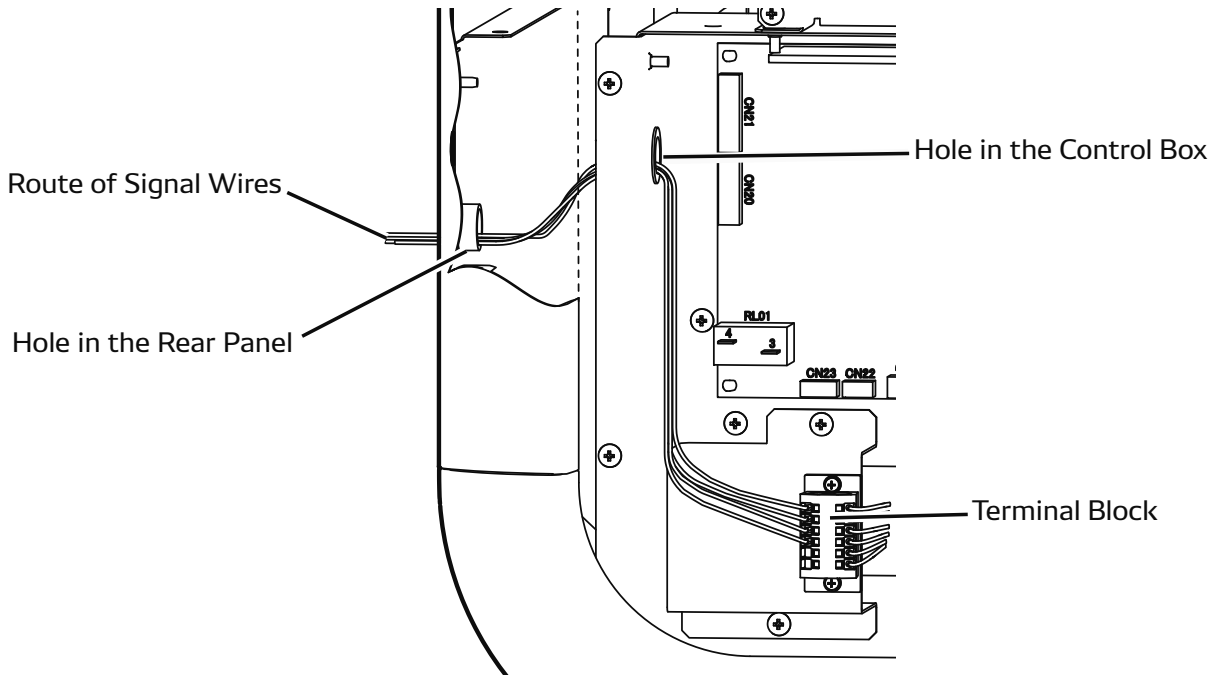

- 6. Connect the alarm signal wires to terminal AL-1 and AL-2 and/or FA-1 and FA-2 as shown in the figure.

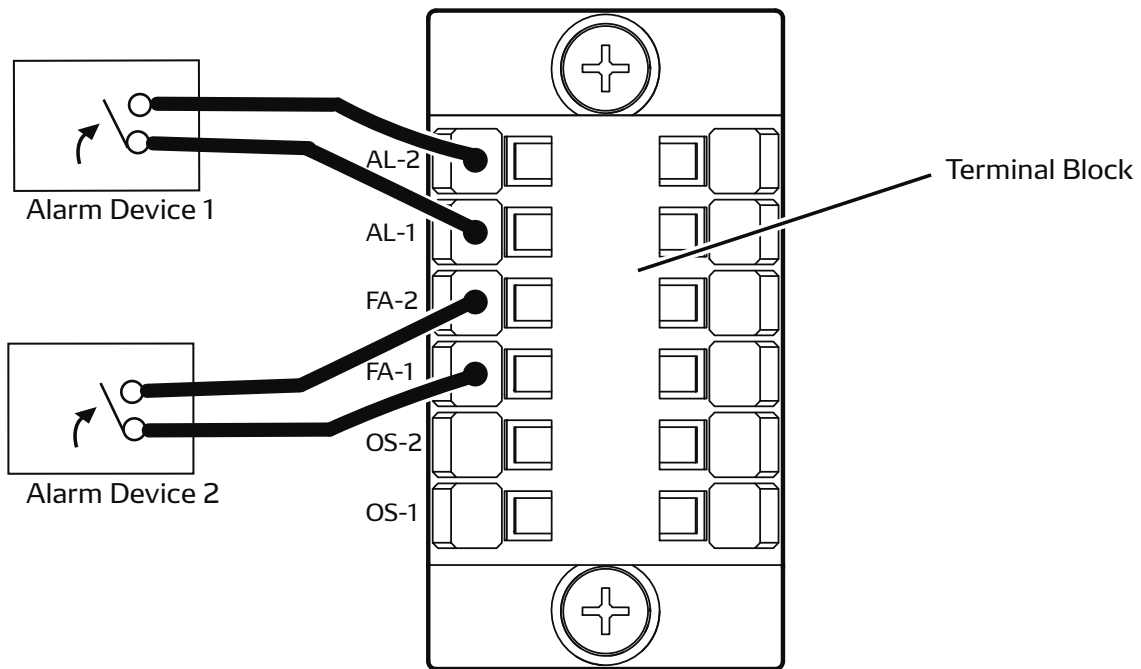

- 7. Reinstall the panels.

# INITIAL SETTINGS

## PRIVACY DISCLOSURE SCREEN

When the unit is connected to the power supply for the first time, PRIVACY DISCLOSURE screen is displayed.

Read the on-screen message.

Press **F** The HOME screen will be displayed.

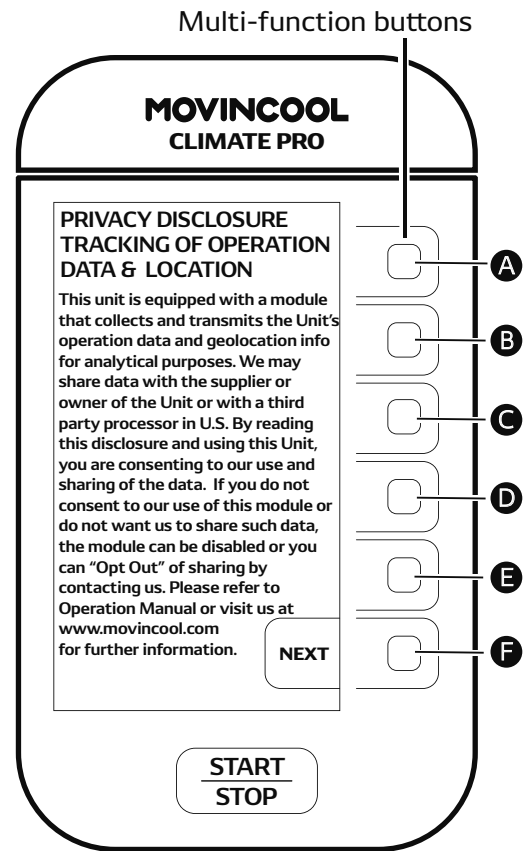

# SELECTING TIME ZONE

Prior to operation, select your time zone.  
The default time zone is PST (UTC-08:00).

1. Press **A** on the HOME screen.

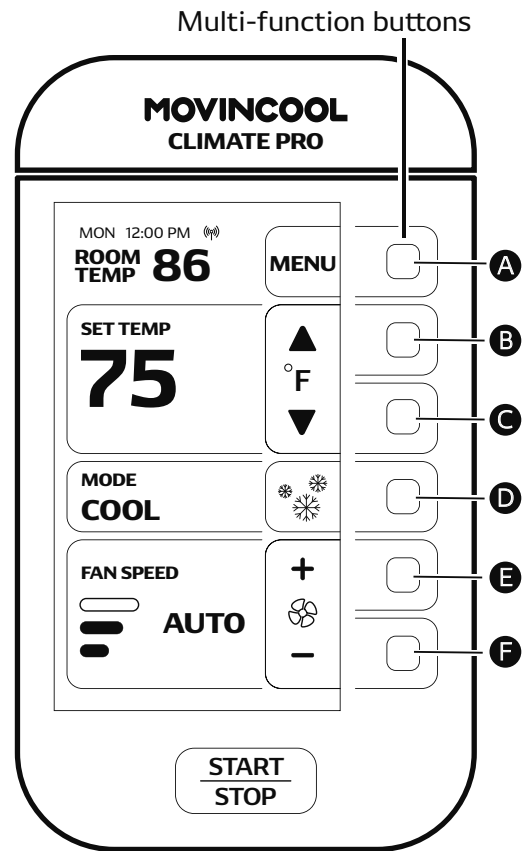

2. Press **B** to select SETTING on the MENU screen.

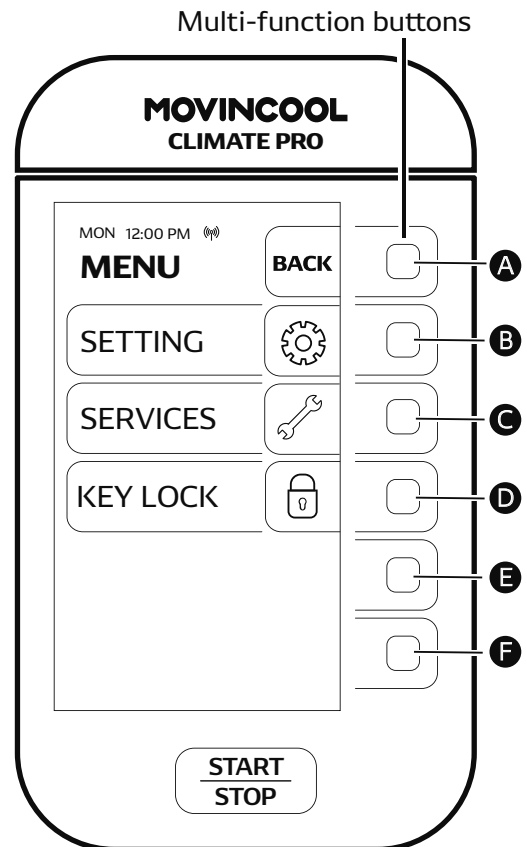

# SELECTING TIME ZONE

3. Press **B** to select DAY & TIME on the SETTING screen.

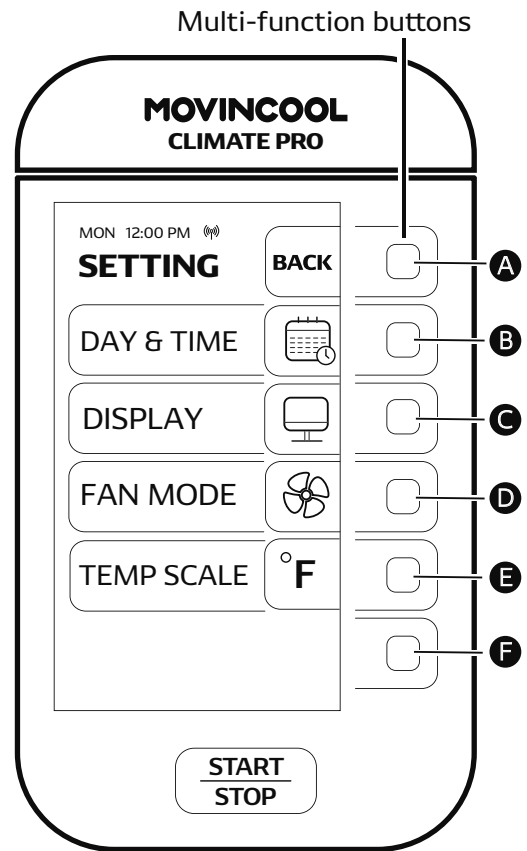

4. Press **D** to go to SELECT TIME ZONE screen.

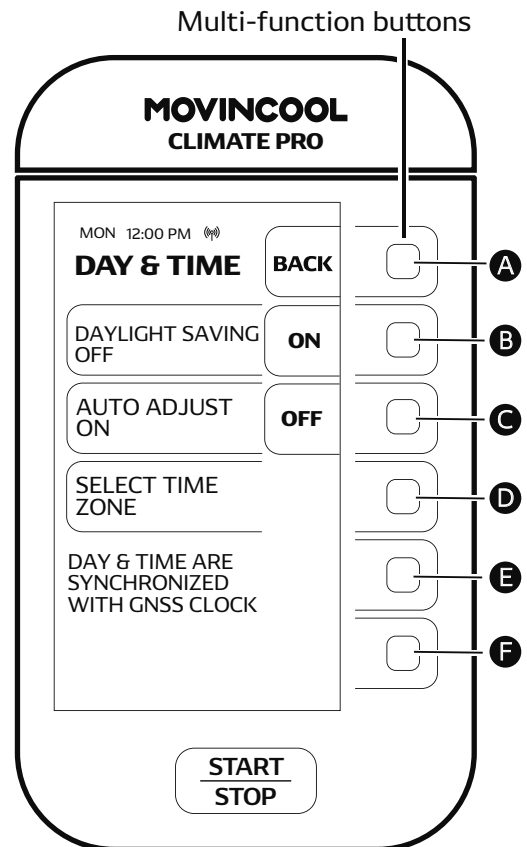

# SELECTING TIME ZONE

5. Select your time zone by pressing **C** or **E** and then press **D** to save.  
The screen returns to the previous screen.  
If you wish to return to the HOME screen, press **A** repeatedly until the HOME screen is displayed.

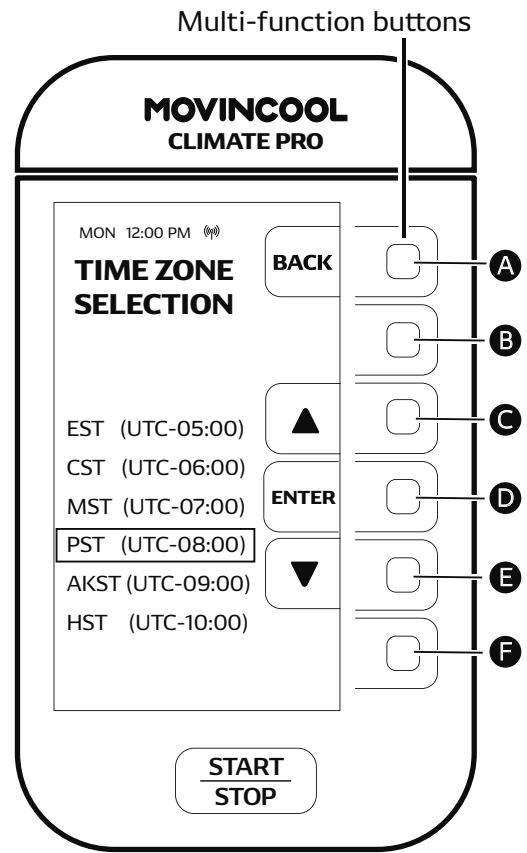

# SETTING DAYLIGHT SAVINGS

When daylight savings start or end, set DAYLIGHT SAVINGS TIME.

1. Press **A** on the HOME screen.

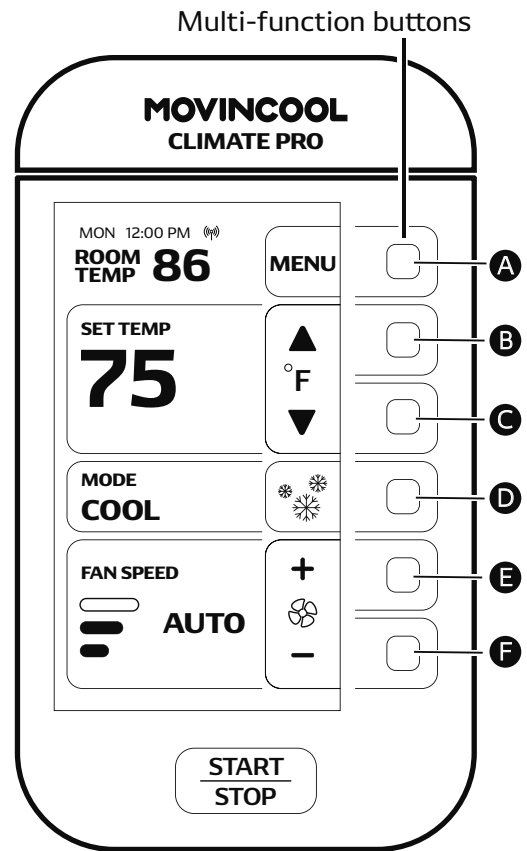

2. Press **B** to select SETTING on the MENU screen.

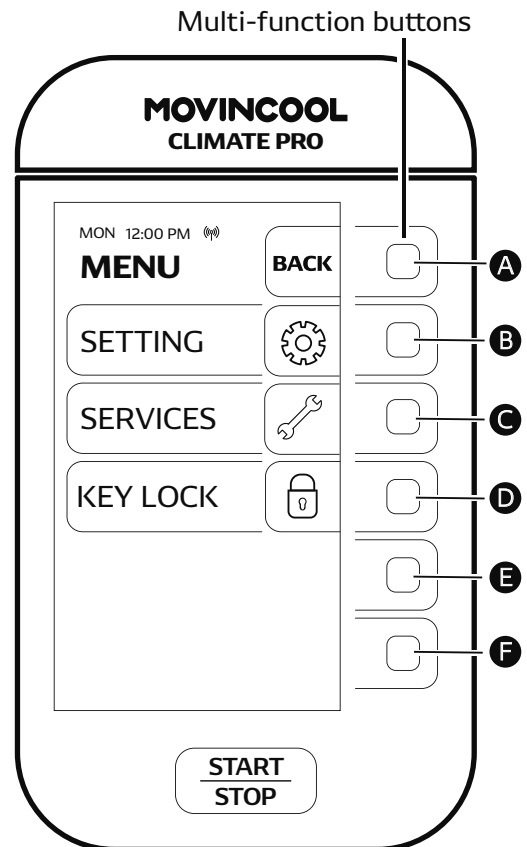

# SETTING DAYLIGHT SAVINGS

3. Press **B** to select DAY & TIME on the SETTING screen.

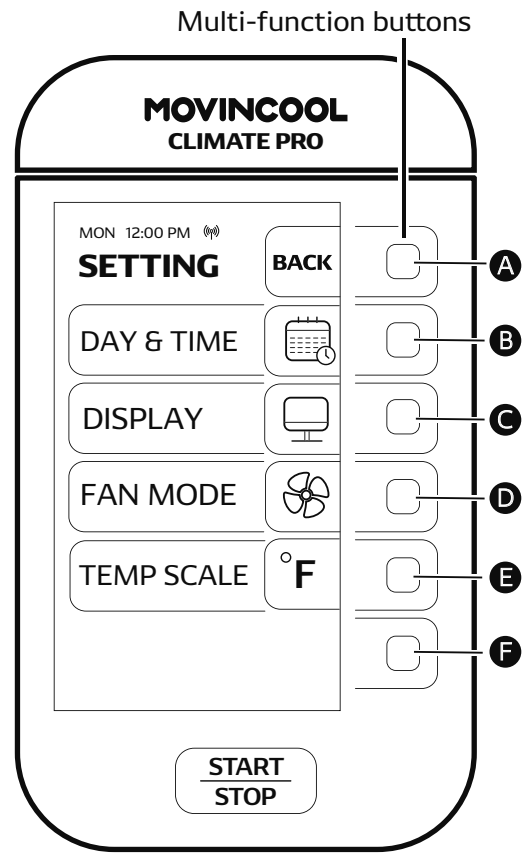

4. Press **B** to switch to ON.  
The default setting of the DAYLIGHT SAVINGS is OFF. If you wish to return to the HOME screen, press **A** repeatedly until the HOME screen is displayed.

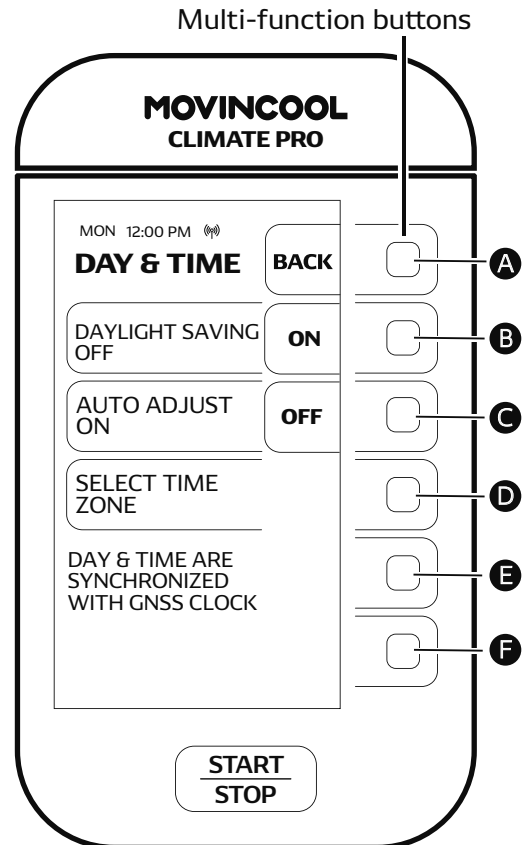

# CLOCK SETTING

Day and time are synchronized with GNSS (Global Navigation Satellite System) clock.

If the time is not adjusted automatically, set the clock manually.

1. Press **A** on the HOME screen.

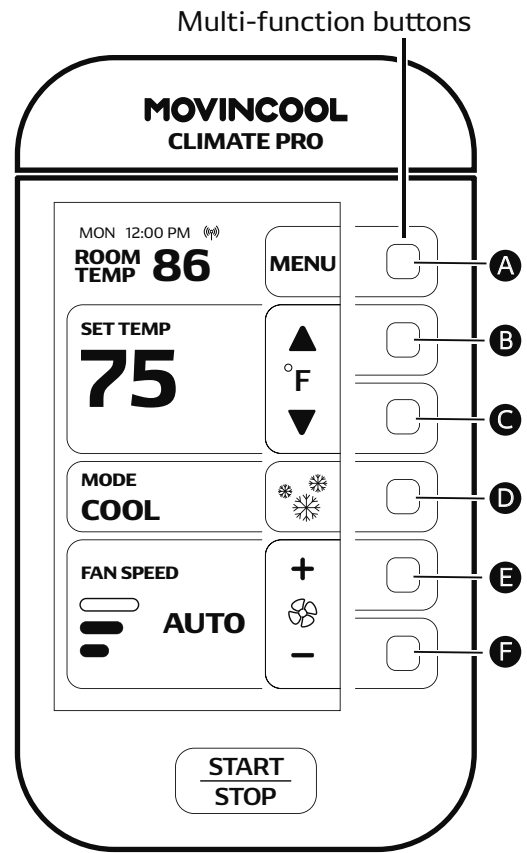

2. Press **B** to select SETTING on the MENU screen.

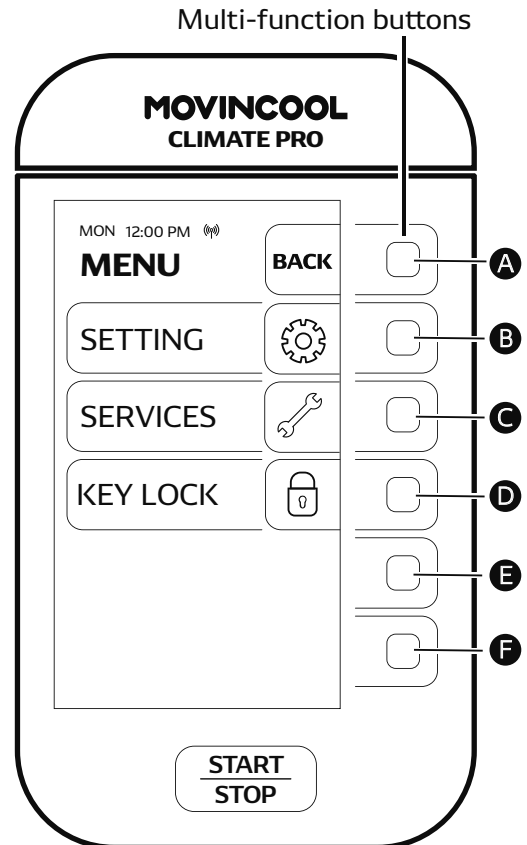



# CLOCK SETTING

3. Press **B** to select DAY & TIME on the SETTING screen.

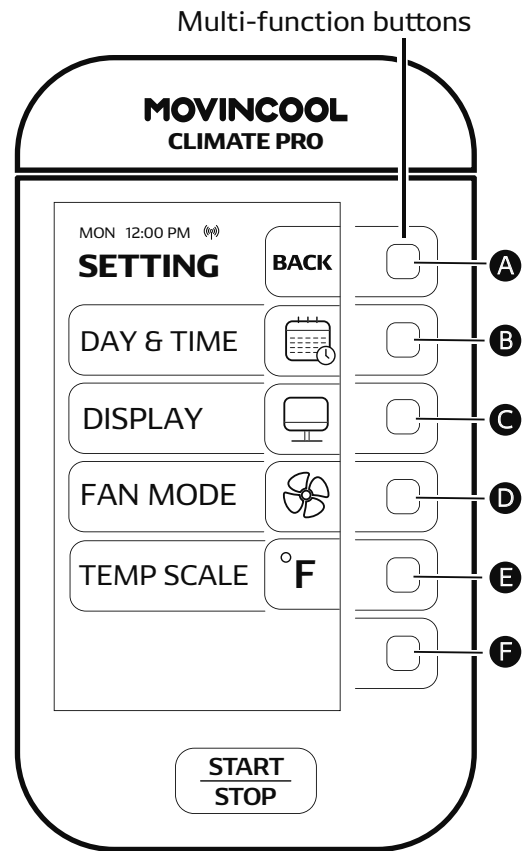

4. Press **C** to switch to AUTO ADJUST OFF.  
The default setting of the AUTO ADJUST is ON.

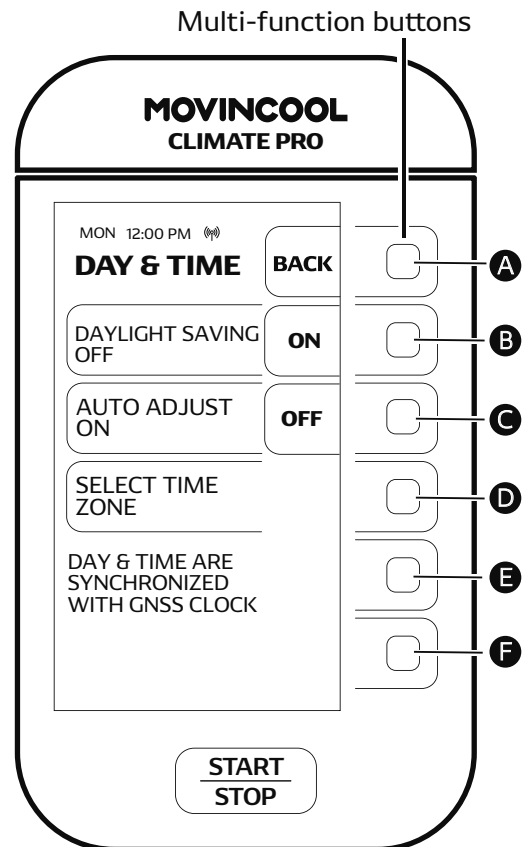

# CLOCK SETTING

- CLOCK SETTING is shown on the DAY & TIME screen. Press **D** to go to CLOCK SETTING screen.

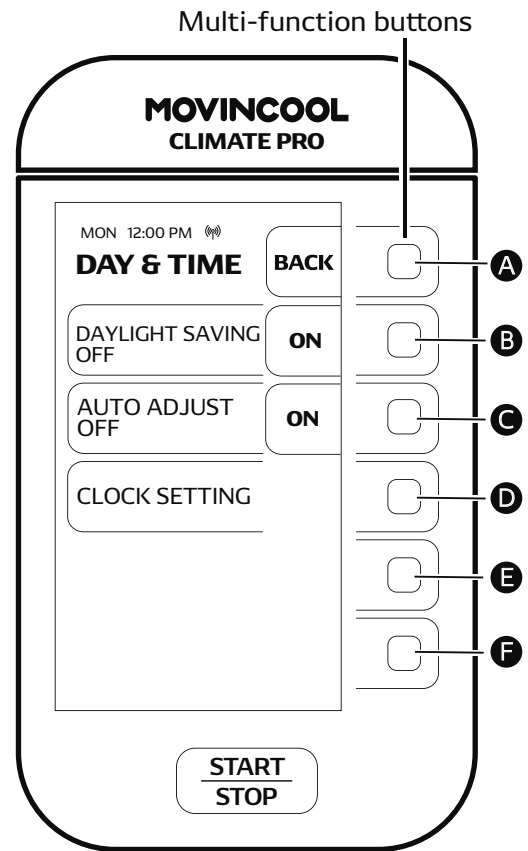

- Select day of the week by pressing **C** or **E** and then press **D**
- Follow the same procedure to set hour and minute.
- Press **F** to save the day and time. The screen returns to the previous screen. If you wish to return to the HOME screen, press **A** repeatedly until the HOME screen is displayed.

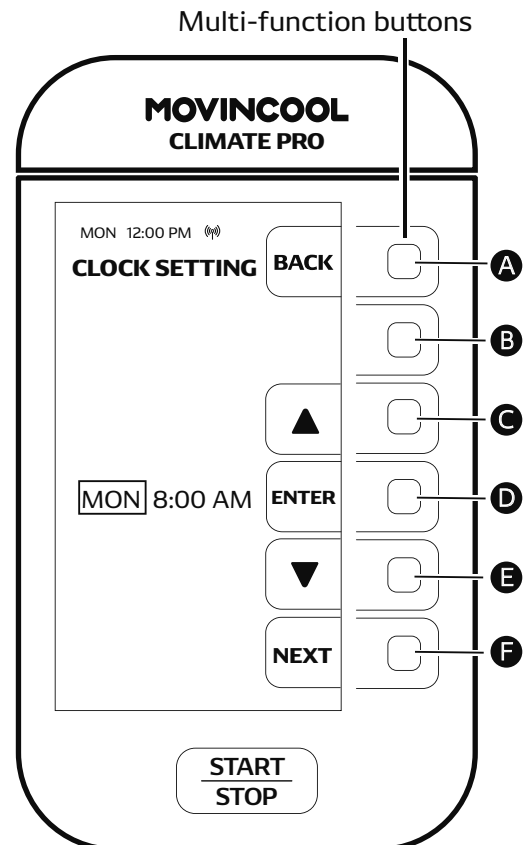

## REMOVING SECURING TAPES AND SHEET

Before starting operation, remove the tapes securing the drain tank, and then take out the packing foam sheet covering the tank. Return the tank to the unit.

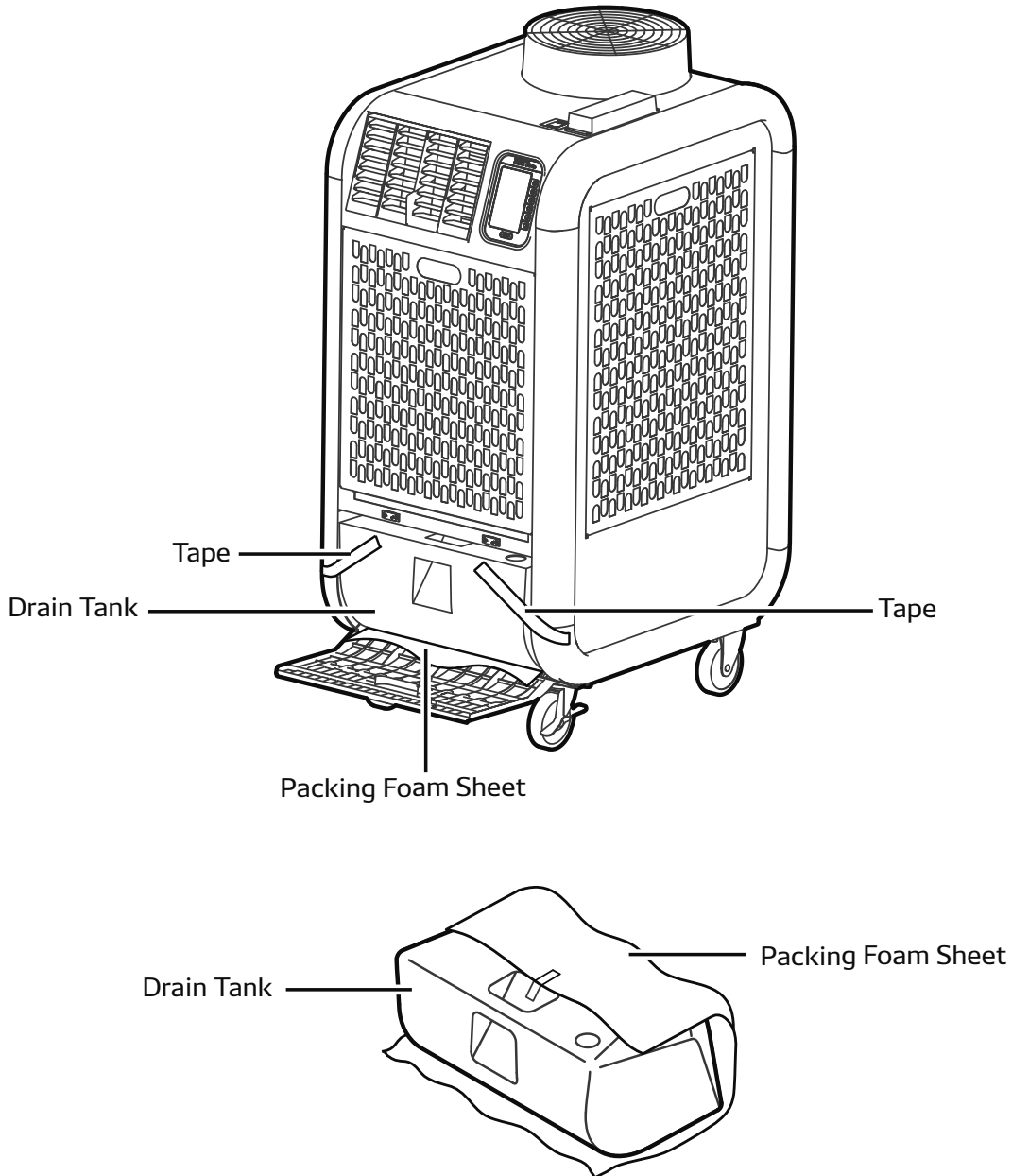

### CAUTION

- Do not operate without the tank. Ensure that the tank is correctly installed. Water leaks from the unit may cause property damage or injury due to wet floor.

# OPERATION

## COOL MODE

The set temperature range is 65°F - 90°F (18°C - 32°C)

1. Press **D** on the HOME screen.

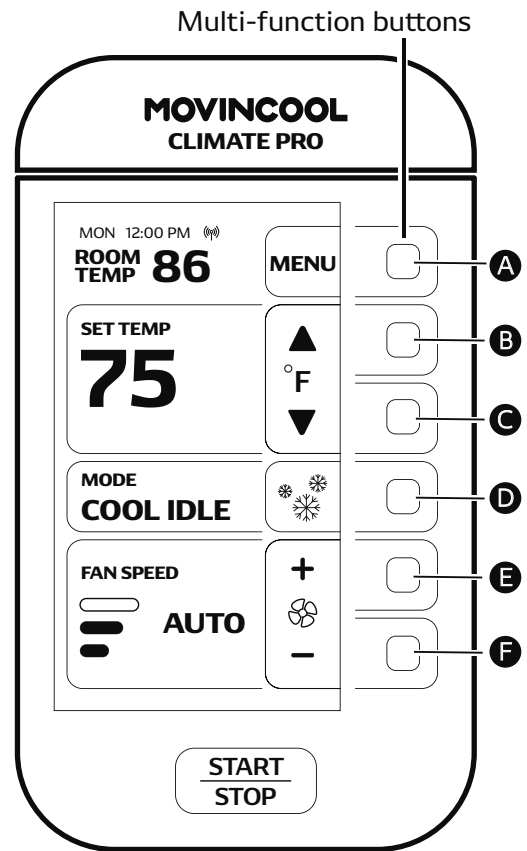

2. Press **B** to select COOL on the MODE screen.

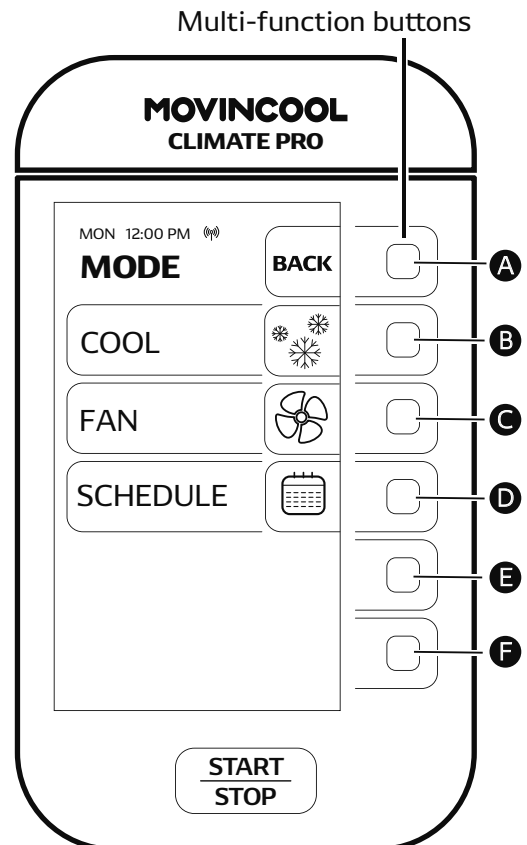

# COOL MODE

- Use **B** or **C** to change the set temperature. If the set temperature reaches the minimum or maximum value, MIN or MAX is displayed.
- Use **E** or **F** to change fan speed (HI, MID, LO).

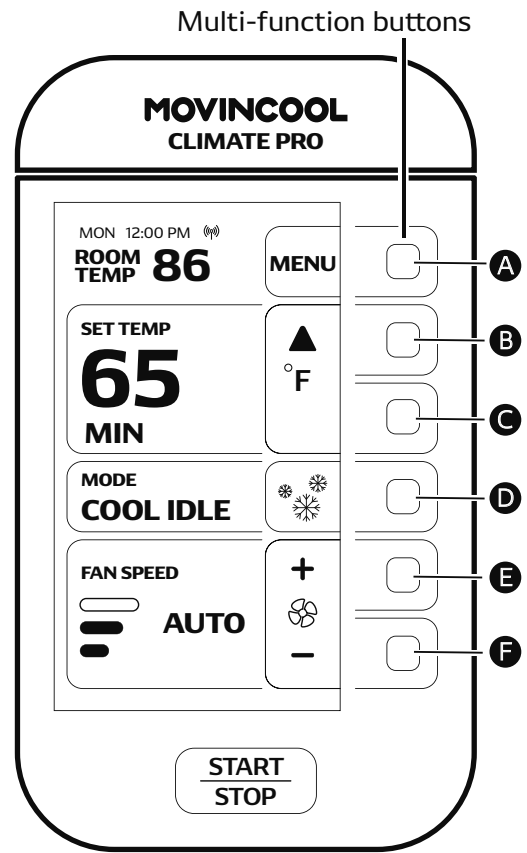

- To start operation, press **START/STOP** on the HOME screen.
- To stop operation, press **START/STOP** on the HOME screen.

**Note:**

- "COOL IDLE" mode is displayed on the HOME screen when COOL mode is not active.
- START/STOP button  
"START" is active only on the HOME screen.  
"STOP" is active on all screens.

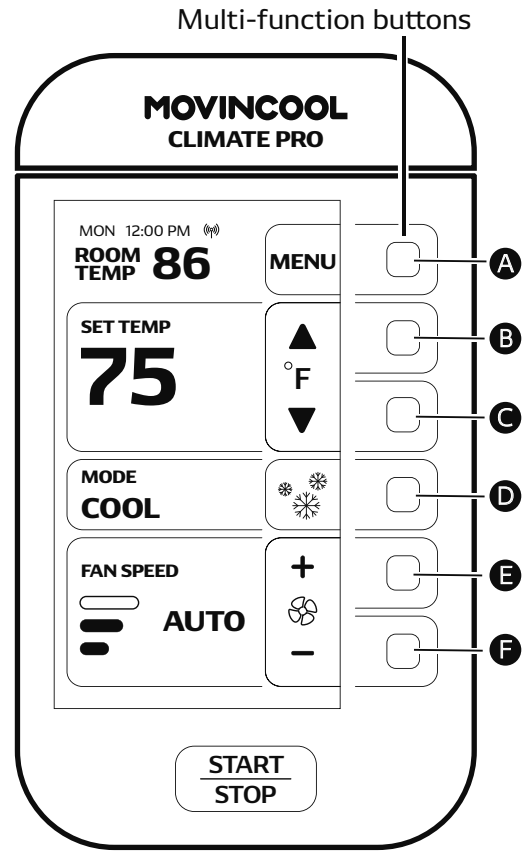

# FAN ONLY MODE

1. Press **D** on the HOME screen.

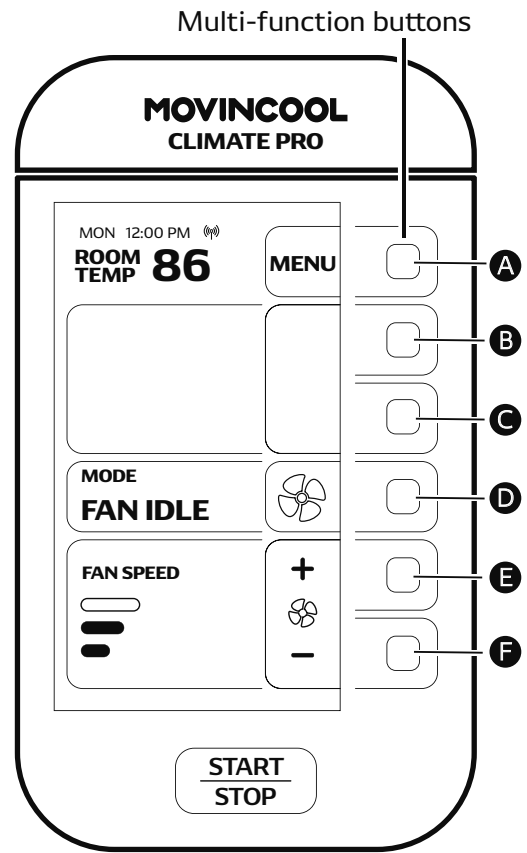

2. Press **C** to select FAN on the MODE screen.

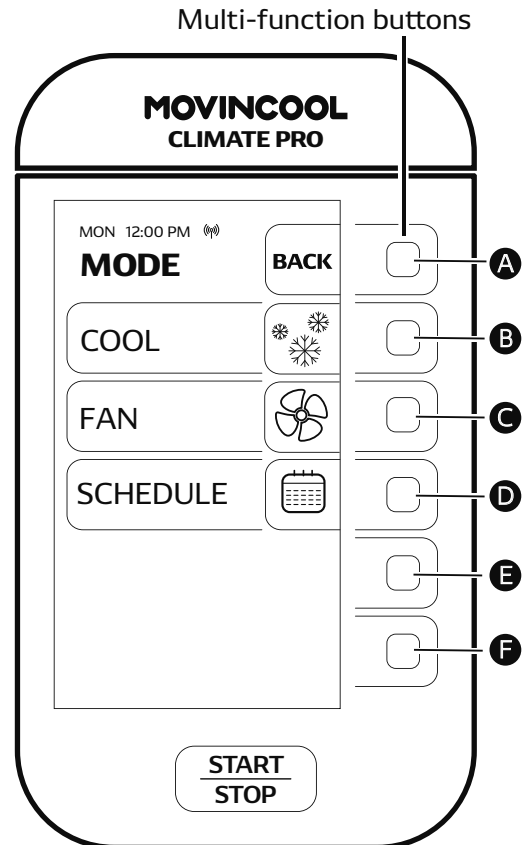

# FAN ONLY MODE

3. Use **E** or **F** to change fan speed (HI, MID, LO).

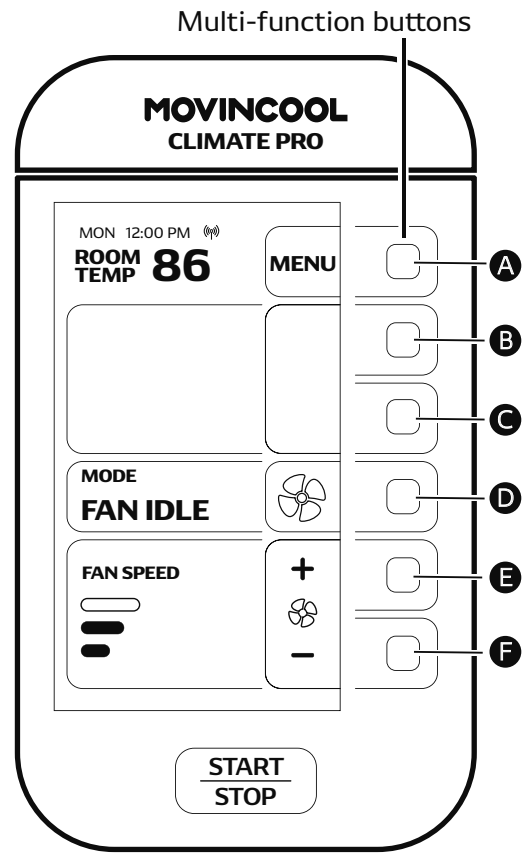

4. To start operation, press on the HOME screen.

5. To stop operation, press on the HOME screen.

**Note:**

- "FAN IDLE" mode is displayed on the HOME screen when FAN mode is not active.
- **START/STOP** button  
 "START" is active only on the HOME screen.  
 "STOP" is active on all screens.

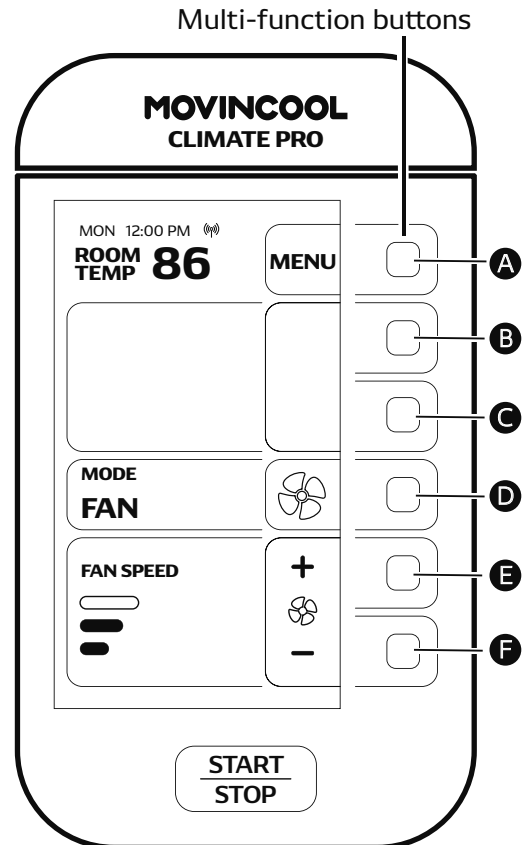

# SCHEDULE MODE

1. Press **D** on the HOME screen.

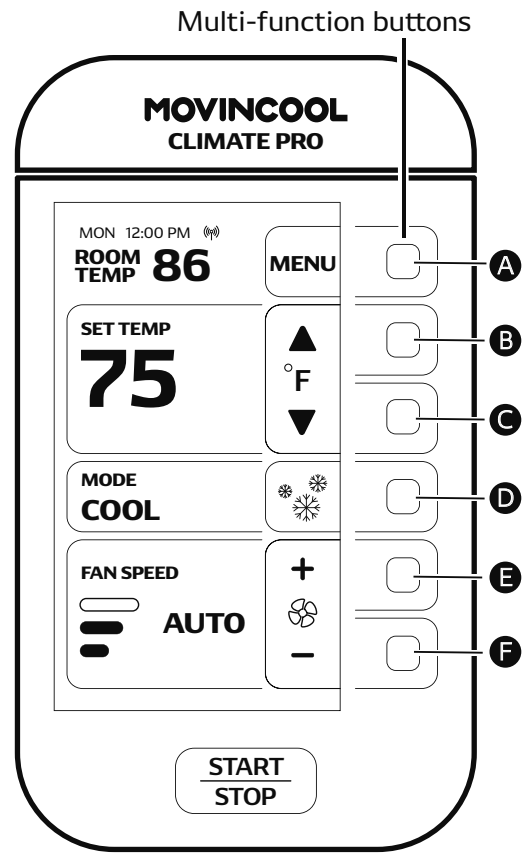

2. Press **D** to select SCHEDULE on the MODE screen.

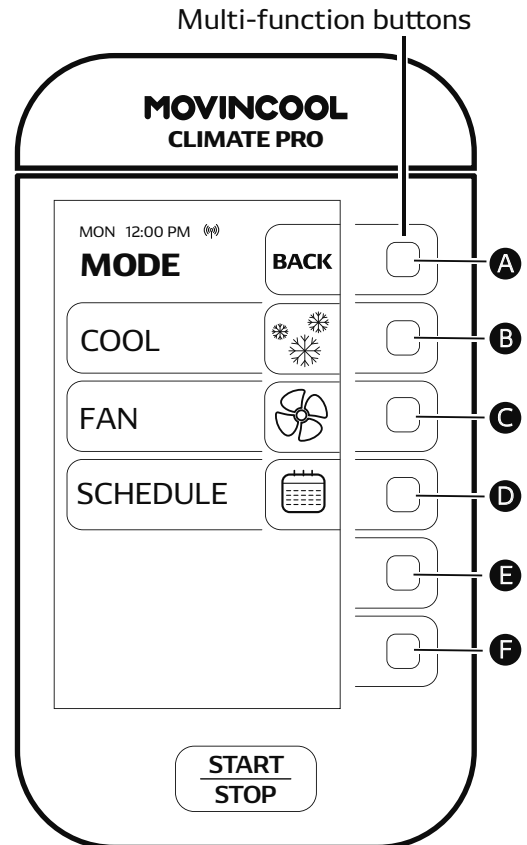



# STARTING SCHEDULE MODE OPERATION

1. Press **B** on the SCHEDULES screen to start SCHEDULE MODE operation. After 3 seconds, the HOME screen will be displayed if no keys are pressed.

If you wish to cancel starting SCHEDULE MODE operation in those 3 seconds, press **B** on the screen below.

Note:

- All key buttons are locked during SCHEDULE MODE operation.

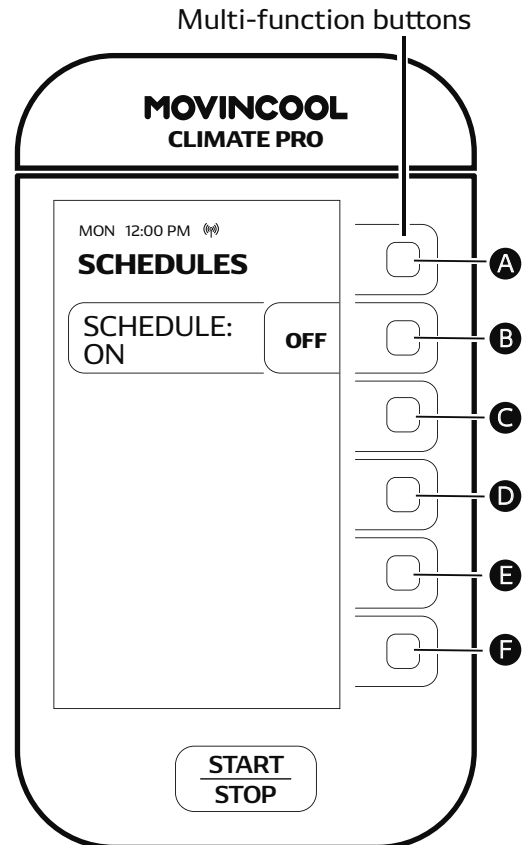
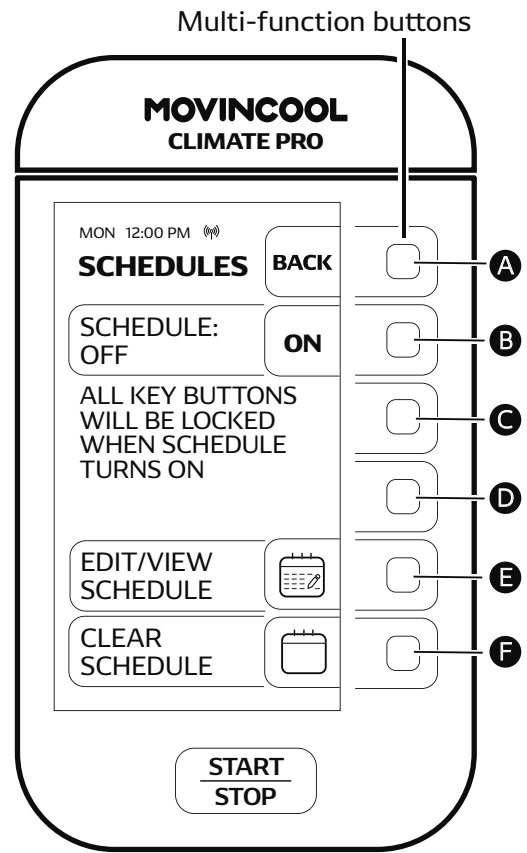

# STARTING SCHEDULE MODE OPERATION

2. "SCHED. COOL" and  (KEY LOCK icon) are displayed on the HOME screen when SCHEDULE MODE operation is running.

Note:

- Refer to page 45 for setting or editing SCHEDULE MODE operation.

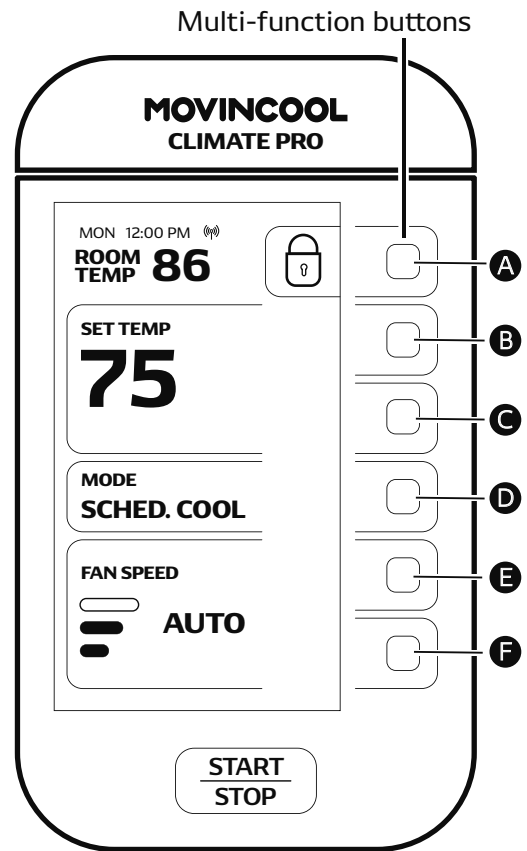

# STOPPING SCHEDULE MODE OPERATION

1. To stop SCHEDULE MODE operation, press and hold **A** for 5 seconds.

After 5 seconds, the screen below will be shown for 3 seconds. If you wish to continue SCHEDULE MODE operation, press **B** on the screen below in those 3 seconds. If you do not press **B** in those 3 seconds, the HOME screen will be displayed.

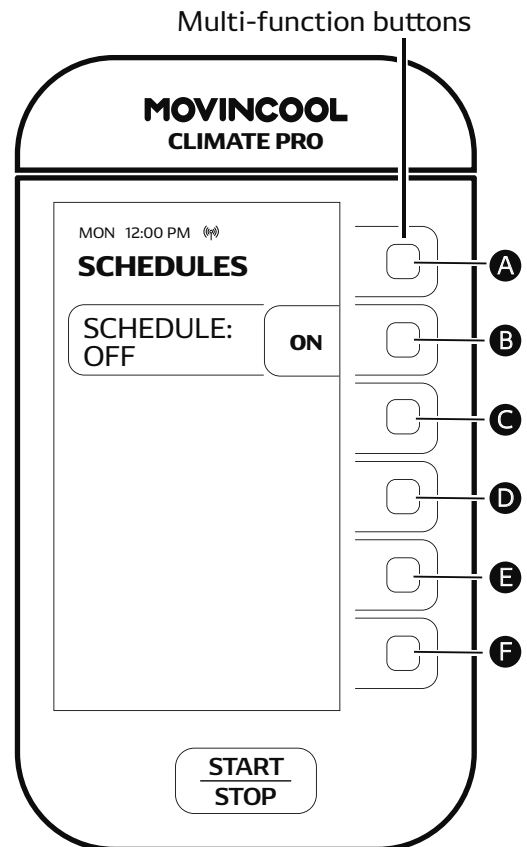
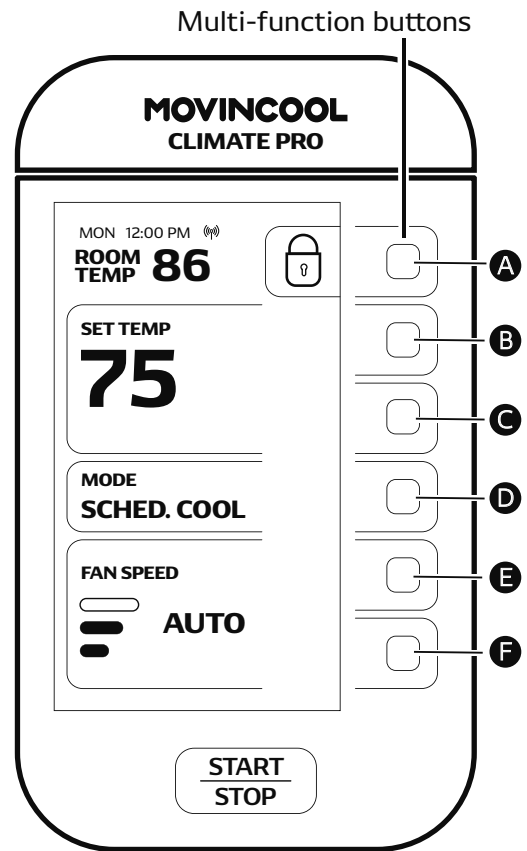

# TEMPORARY STOP DURING SCHEDULE MODE

If **START STOP** is pressed for an emergency stop or pressed accidentally during SCHEDULE MODE operation, "TEMPORARY STOP REFER TO OPERATION MANUAL TO RESUME OPERATION" is displayed.

1. To release TEMPORARY STOP, press and hold **A** for 5 seconds. After 5 seconds, the screen below will be shown for 3 seconds. To continue SCHEDULE MODE operation, you must press **B** on the screen below in those 3 seconds. If you do not press **B** in those 3 seconds, you must start SCHEDULE MODE operation on the SCHEDULES screen.

Note:

- The TEMPORARY STOP message will automatically disappear if the next SCHEDULE MODE operation starts.

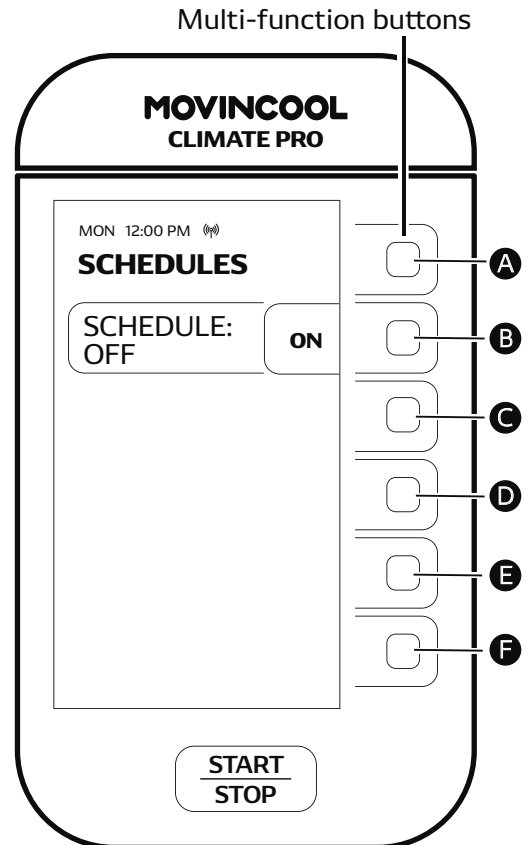
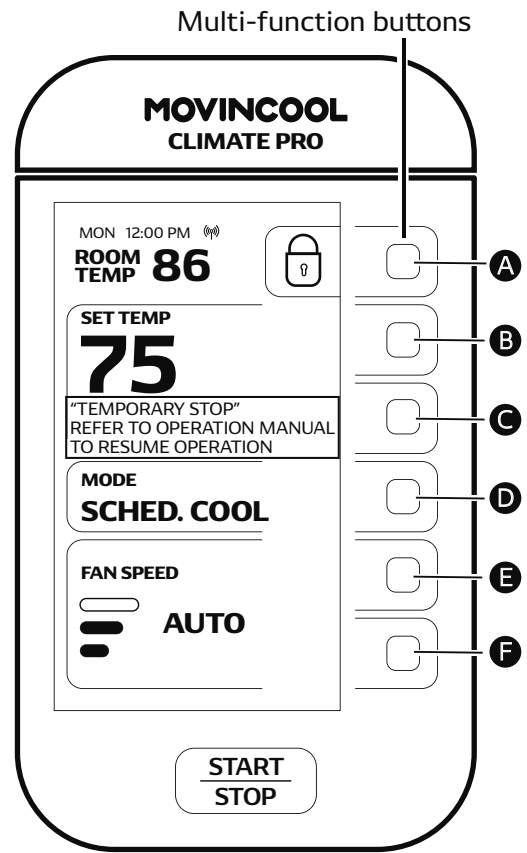

# SETTING / EDITING / VIEWING SCHEDULE

1. Press **D** on the HOME screen.

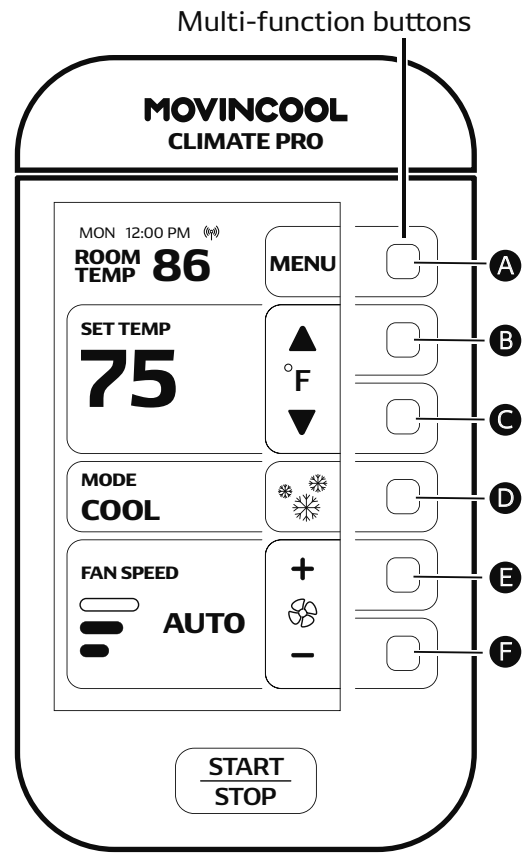

2. Press **D** to select SCHEDULE on the MODE screen.

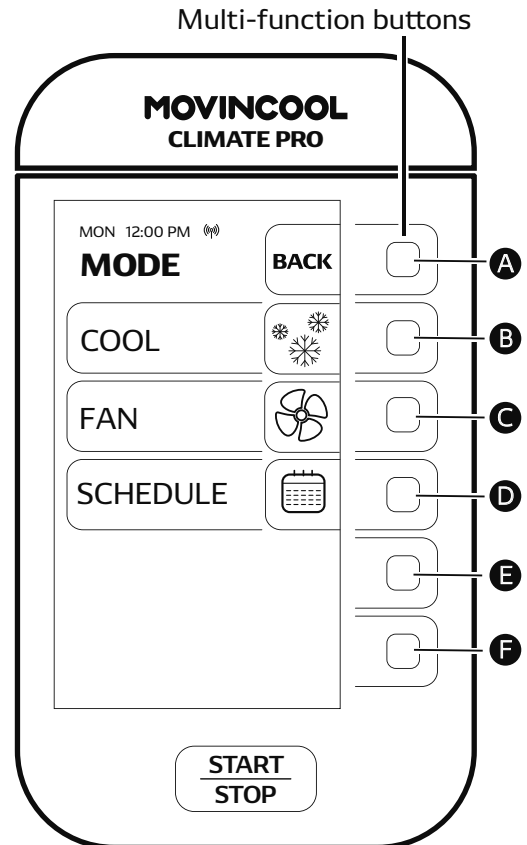

# SETTING / EDITING / VIEWING SCHEDULE

- To edit or view SCHEDULE MODE operation, press **E** on the SCHEDULES screen. The EDIT/VIEW SCHEDULES screen is then shown.

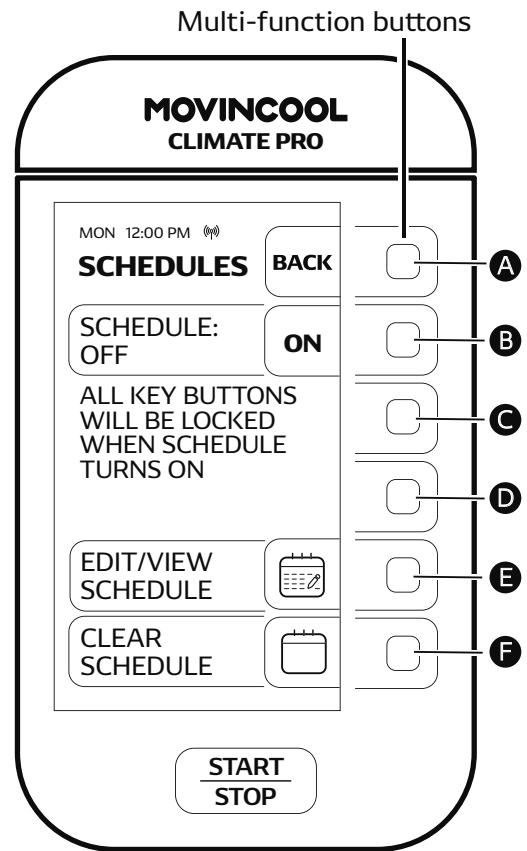

- Edit or view program number by pressing **F**. Up to 10 programs can be set (P1 to P10).
- Edit desired START TIME (day, hour, minute), STOP TIME (day, hour, minute), MODE, SET TEMP, FAN MODE, and FAN SPEED by pressing **C** or **E**. Press **D** each time setting value is determined.
- When editing is complete, press **F** to save the programs. Press **A** to return to the SCHEDULES screen, and then start SCHEDULE MODE operation. Refer to page 41.  
If you wish to return to the HOME screen, press **A** repeatedly until the HOME screen is displayed.

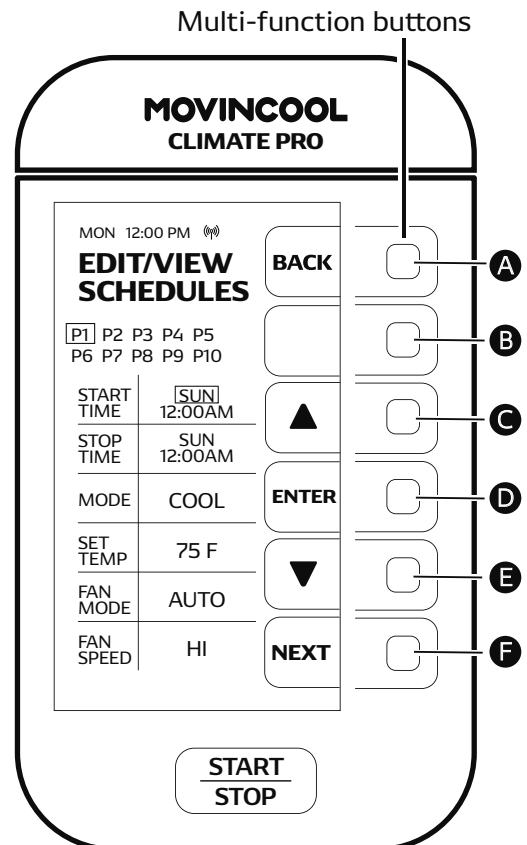

# SETTING / EDITING / VIEWING SCHEDULE

Note:

- If the start or stop time chosen for programs overlaps with any other program, "SETTING TIME ERROR" will be displayed. Press any button to clear the message. Reset program times.

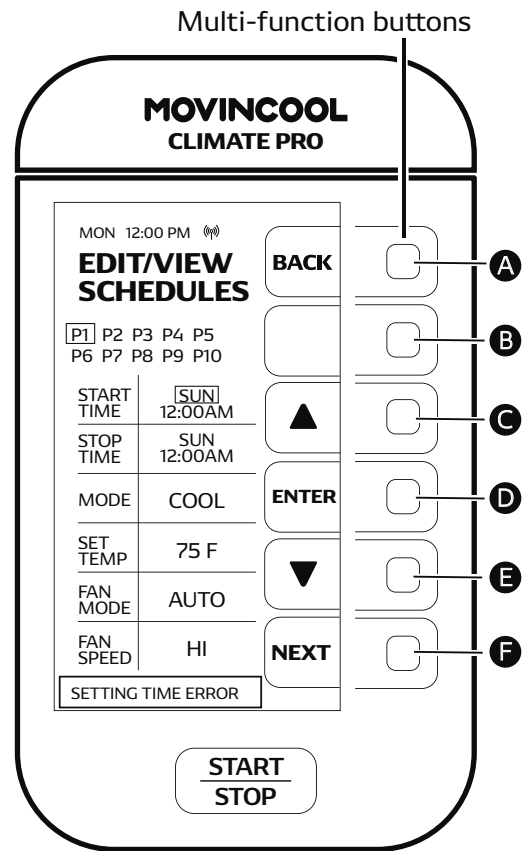

# CLEARING SCHEDULE

1. Press **D** on the HOME screen.

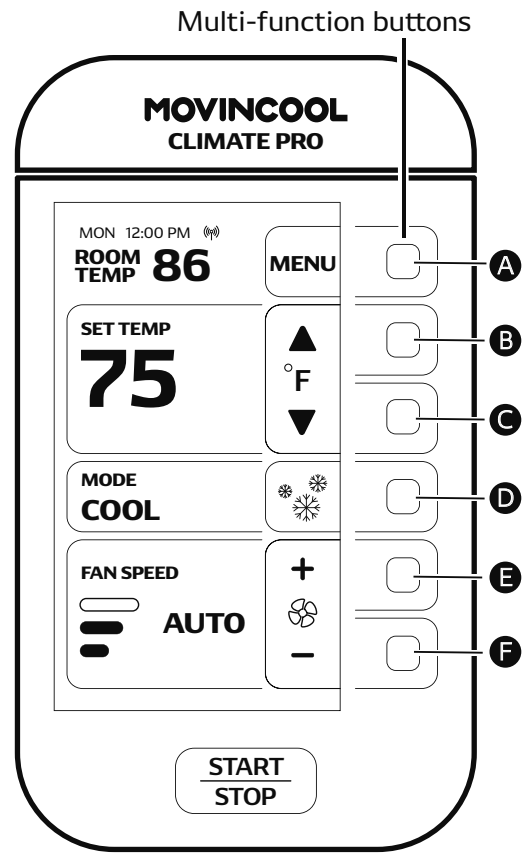

2. Press **D** to select SCHEDULE on the MODE screen.

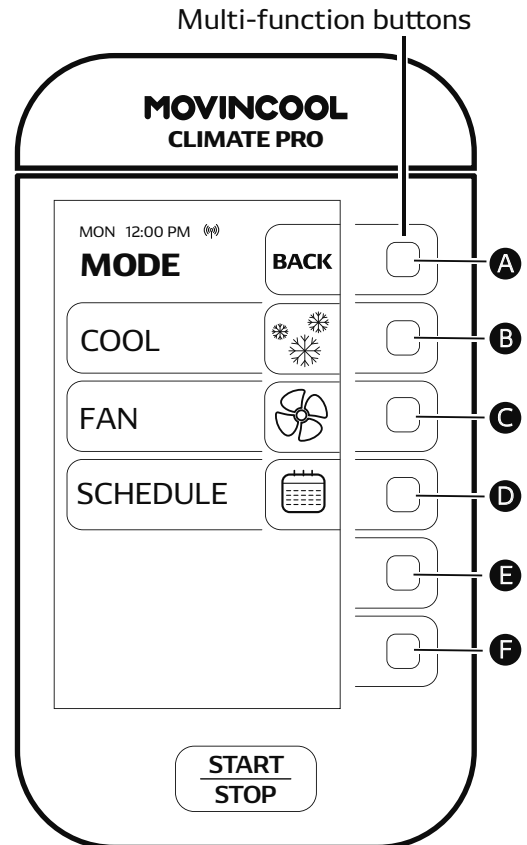



# CLEARING SCHEDULE

- To clear SCHEDULE MODE operation, press **F** on the SCHEDULES screen. The confirmation screen is then shown.

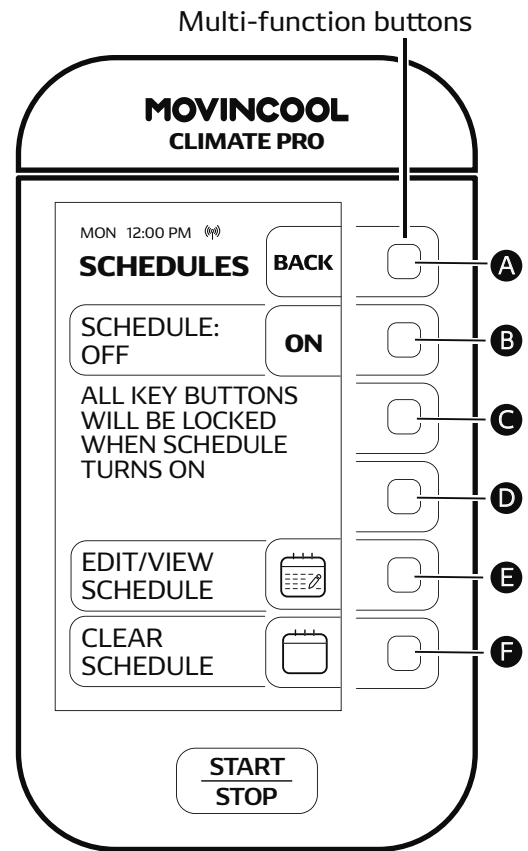

- The message "ALL SET SCHEDULES WILL BE CLEARED FROM MEMORY" is displayed. Press **B** if you wish to clear all set schedules. The screen then returns to the previous screen. If you wish to return to the HOME screen, press **A** repeatedly until the HOME screen is displayed.

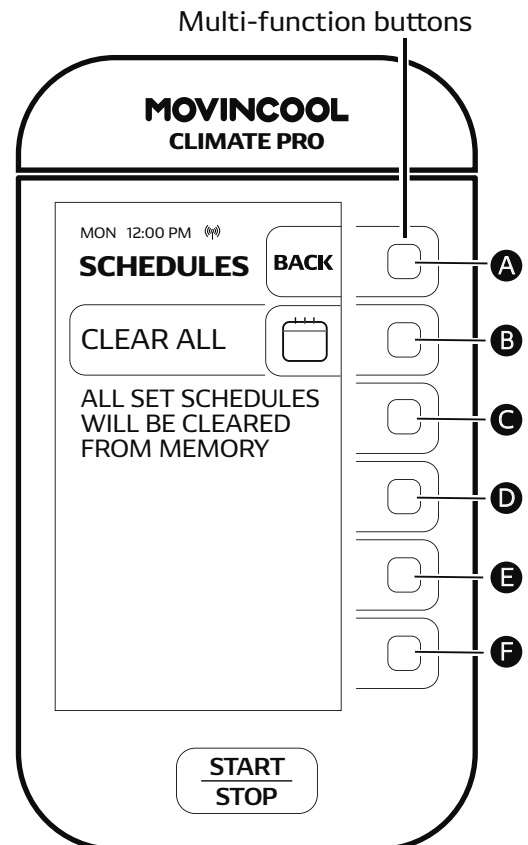

# ADJUSTING BRIGHTNESS

1. Press **A** on the HOME screen.

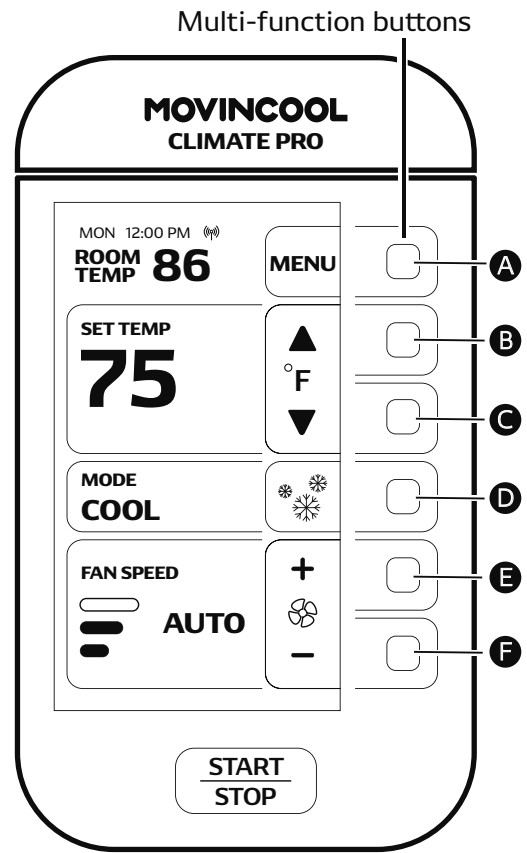

2. Press **B** to select SETTING on the MENU screen.

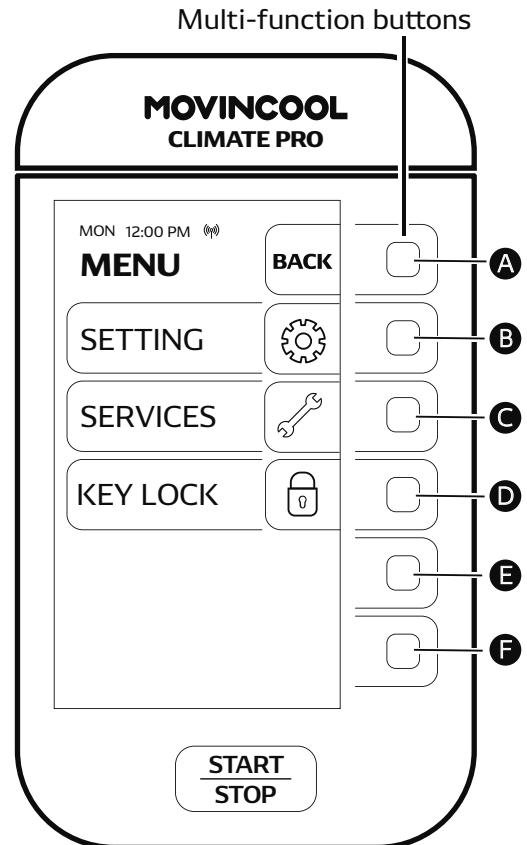

# ADJUSTING BRIGHTNESS

3. Press **C** to select DISPLAY on the SETTING screen.

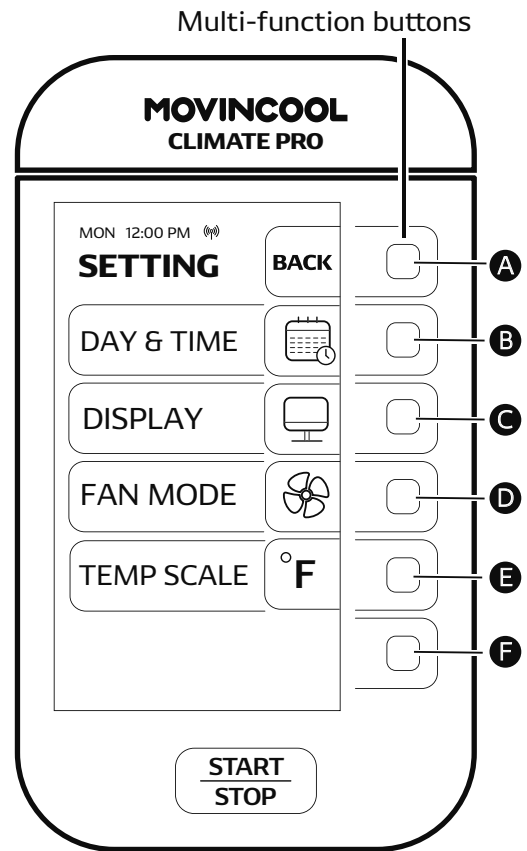

4. Press **C** or **E** to adjust the brightness level and then press **D** to save.

The screen returns to the previous screen.

If you wish to return to the HOME screen, press **A** repeatedly until the HOME screen is displayed.

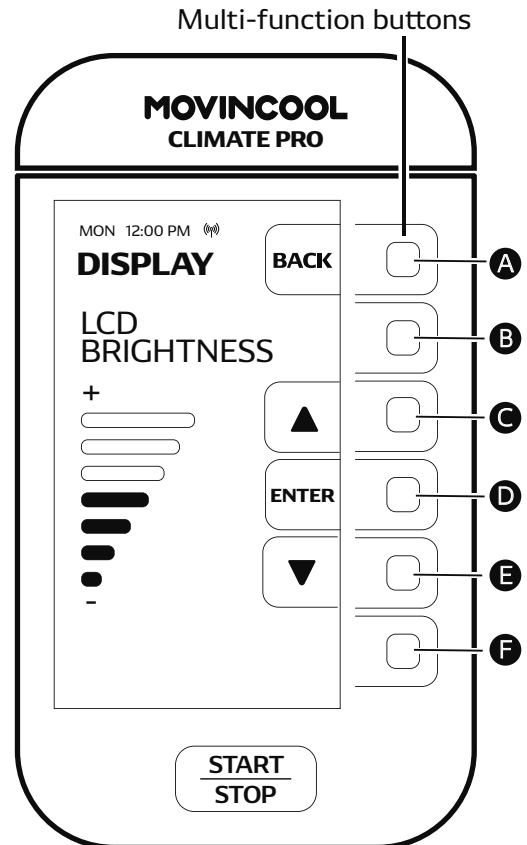

# FAN MODE

The fan mode determines whether the fan continues to run or stop when the room temperature reaches the set temperature. The default setting is ON.

**ON** : Fan constantly runs whether the unit is operating in COOL mode or not.

**AUTO**: Fan only runs when the unit is operating in COOL mode.

1. Press **A** on the HOME screen.

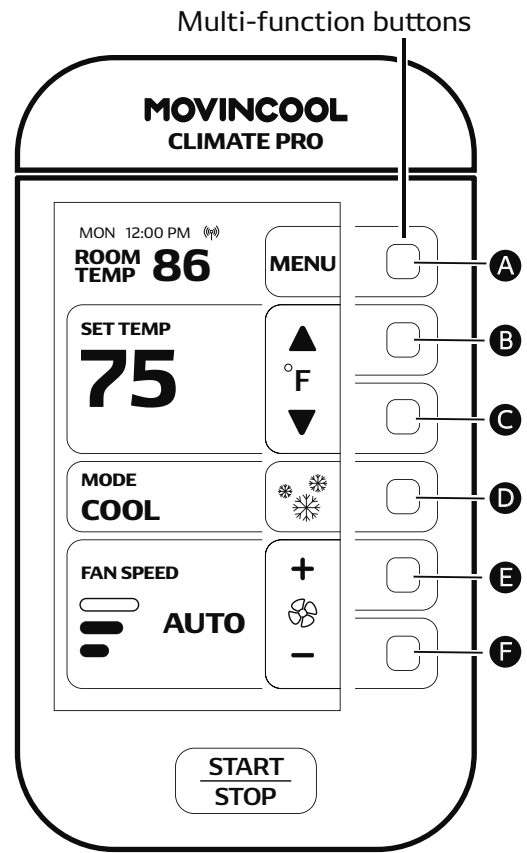

2. Press **B** to select SETTING on the MENU screen.

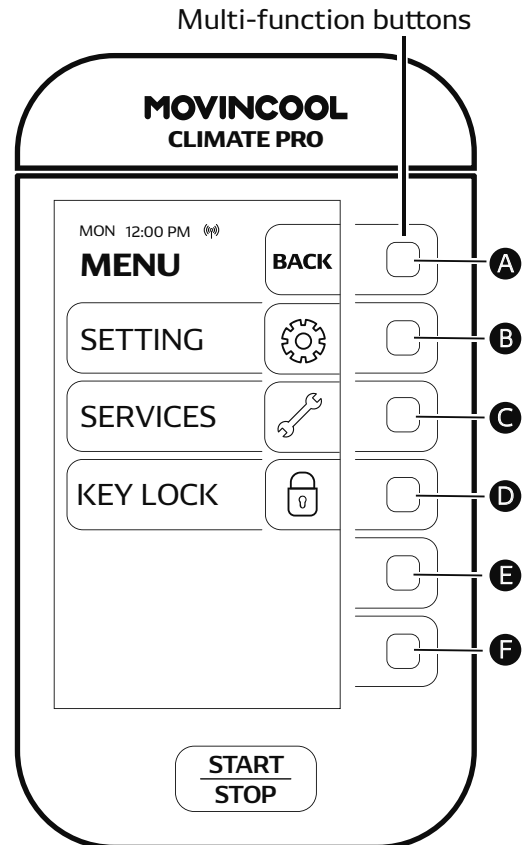

# FAN MODE

3. Press **D** to select FAN MODE on the SETTING screen.

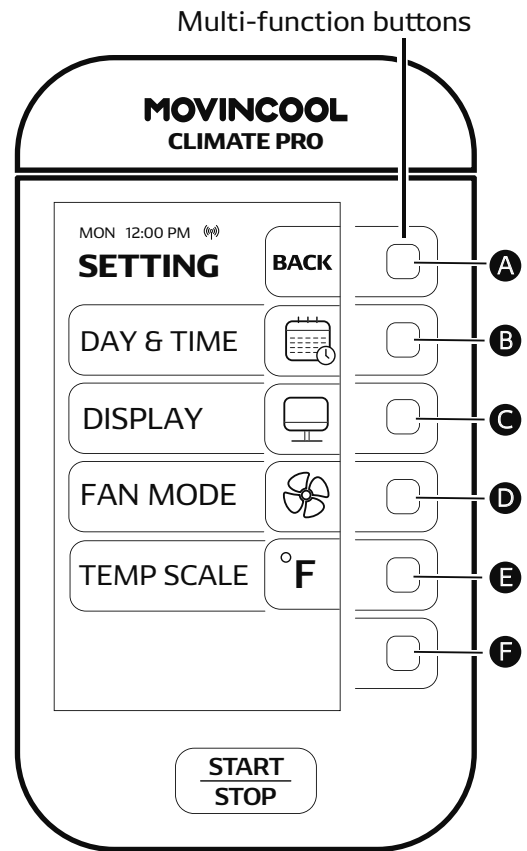

4. Press **B** to switch to AUTO.  
The default setting of the FAN MODE is ON.  
If you wish to return to the HOME screen, press **A** repeatedly until the HOME screen is displayed.

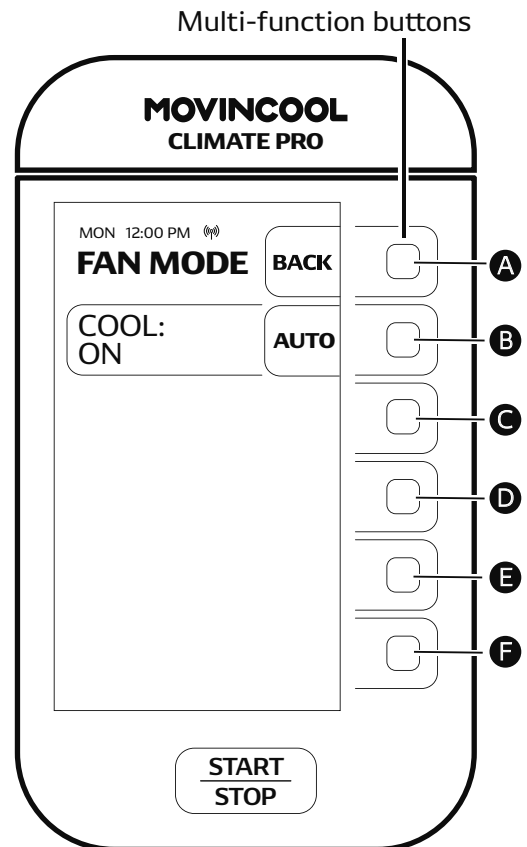

# CHANGING TEMPERATURE SCALE

TEMP SCALE is only displayed while the unit is not in operation.

1. Press **A** on the HOME screen.

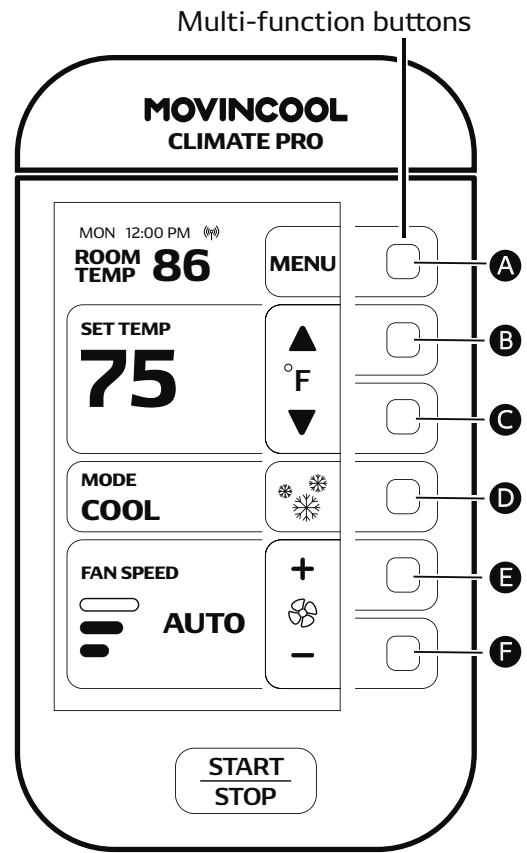

2. Press **B** to select SETTING on the MENU screen.

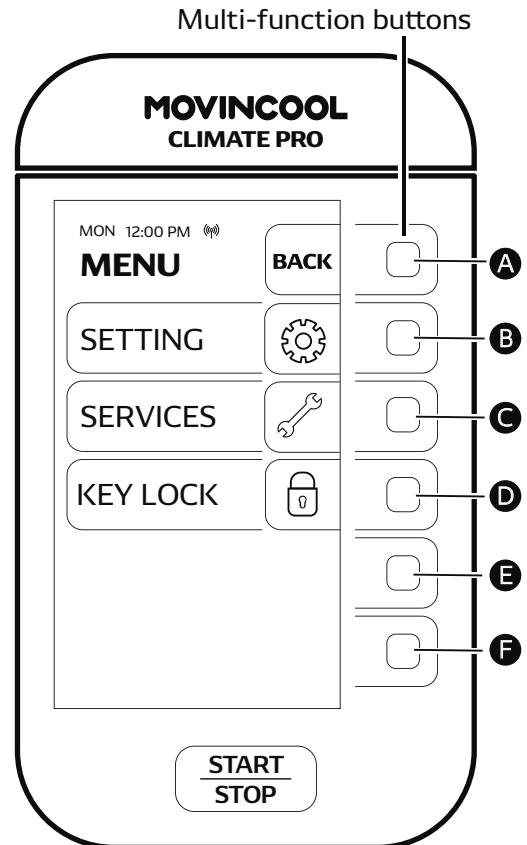

# CHANGING TEMPERATURE SCALE

3. Press **E** to select TEMP SCALE on the SETTING screen.

Note:

- TEMP SCALE is only displayed while the unit is not in operation.

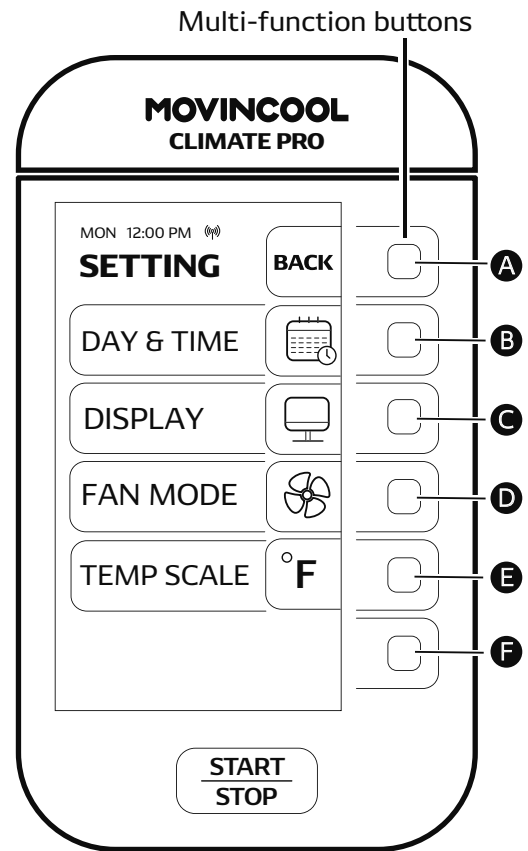

4. Press **B** to switch to °C  
The default setting of the TEMP SCALE is °F  
If you wish to return to the HOME screen, press **A** repeatedly until the HOME screen is displayed.

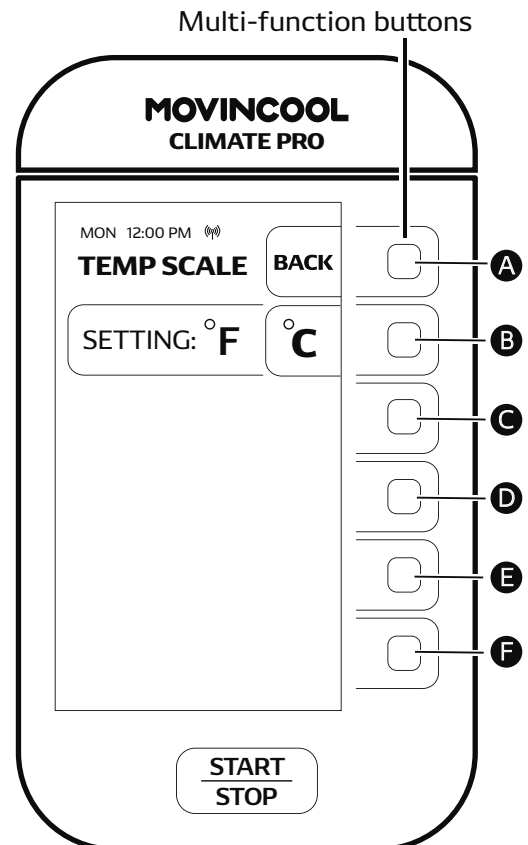

# KEY LOCK

Key lock disables all buttons on the control panel.

1. Press **A** on the HOME screen.

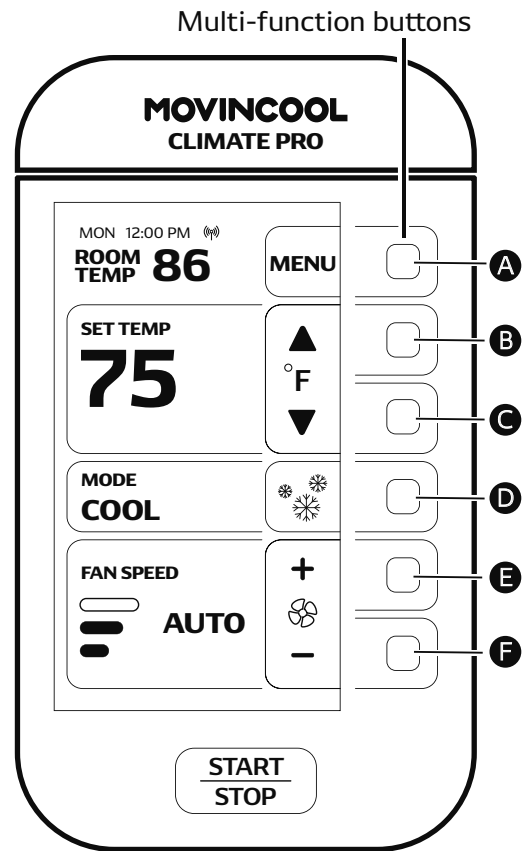

2. Press **D** to select KEY LOCK on the MENU screen. The HOME screen will be shown.

Note:

- During SCHEDULE MODE operation, all buttons are automatically locked.

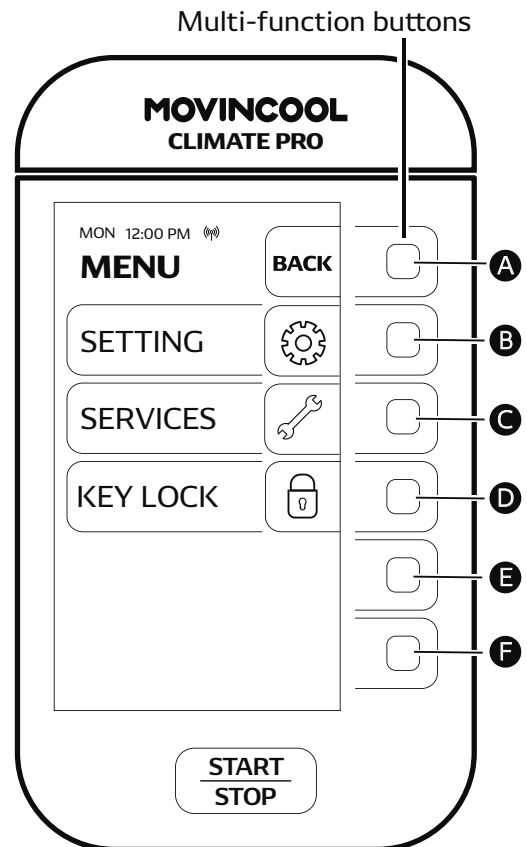



# KEY UNLOCK

1. To unlock the keys, press and hold **A** for 5 seconds.

After 5 seconds, the screen below will be shown for 3 seconds. If you wish to continue KEY LOCK, press **B** on the screen below in those 3 seconds. If you do not press **B** in those 3 seconds, the HOME screen will be displayed.

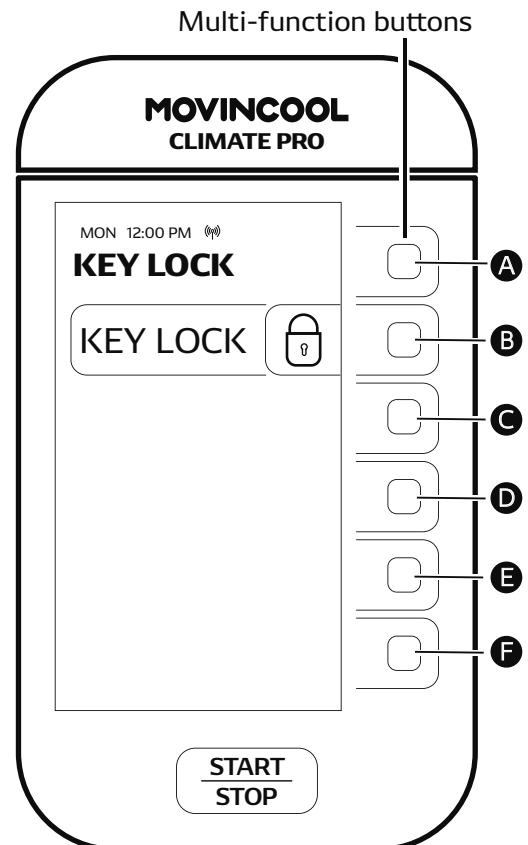
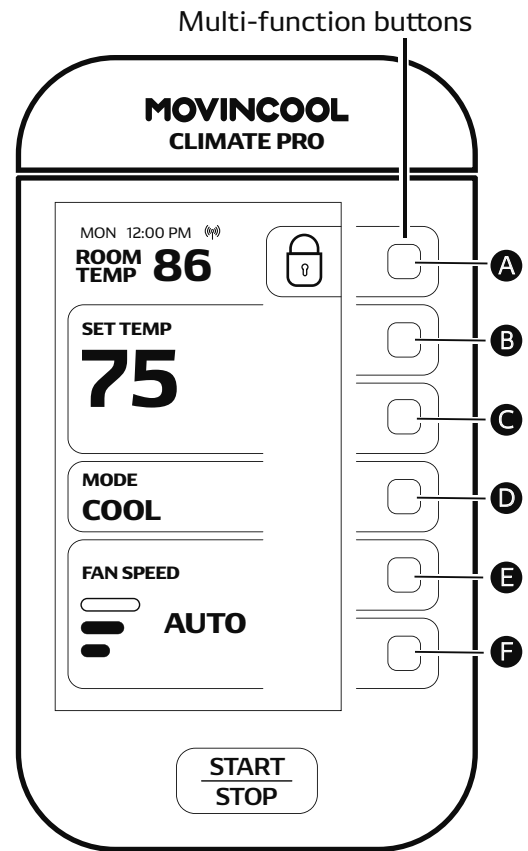

Note:

- All buttons are automatically unlocked when a self-diagnostic code is displayed. (See page 63)



# TEMPORARY STOP DURING KEY LOCK

If  is pressed for emergency stop or accidentally during key lock, "TEMPORARY STOP: REFER TO OPERATION MANUAL TO RESUME OPERATION" is displayed.

1. To release TEMPORARY STOP, press and hold  for 5 seconds.
2. Press  to start operation.

**Note:**

- If you wish to lock keys, refer to page 56.

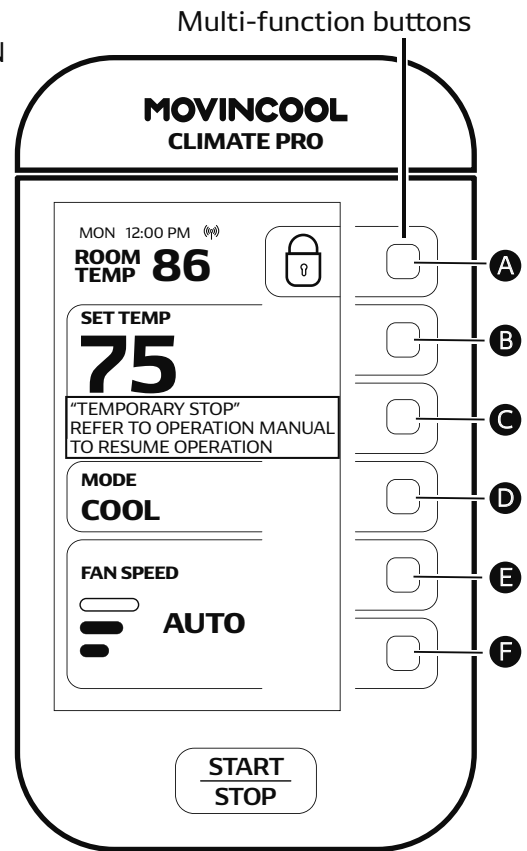

# SERVICE INFORMATION

Machine information can be displayed.

1. Press **A** on the HOME screen.

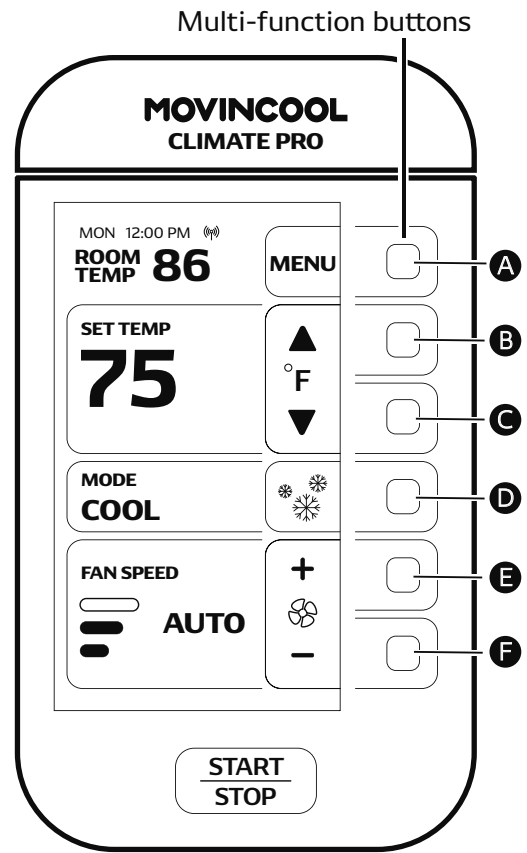

2. Press **C** to select SERVICES on the MENU screen.

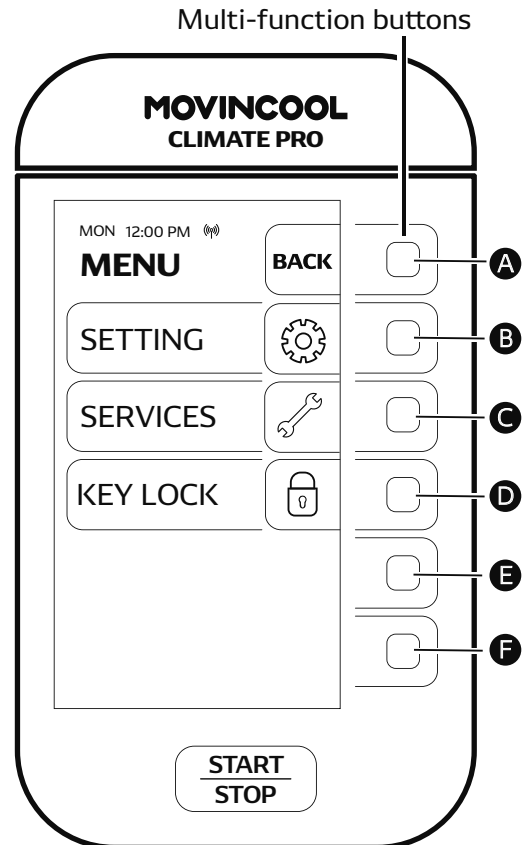

# SERVICE INFORMATION

1. Press **B** to select MACHINE INFORMATION on the SERVICES screen.

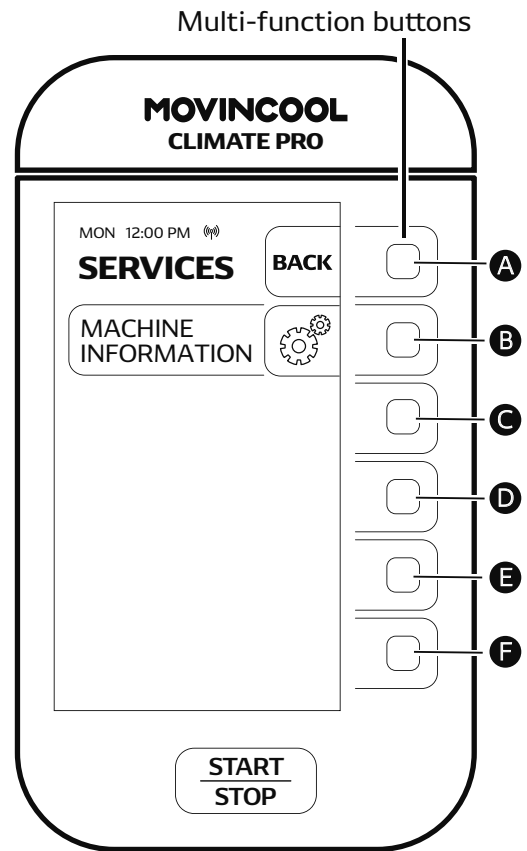

2. The MACHINE INFORMATION screen is displayed. If you wish to see MACHINE STATUS, press **B**. If you wish to see MACHINE RECORDS, press **C**.

**Note:**

- Technical information is available by scanning QR code.

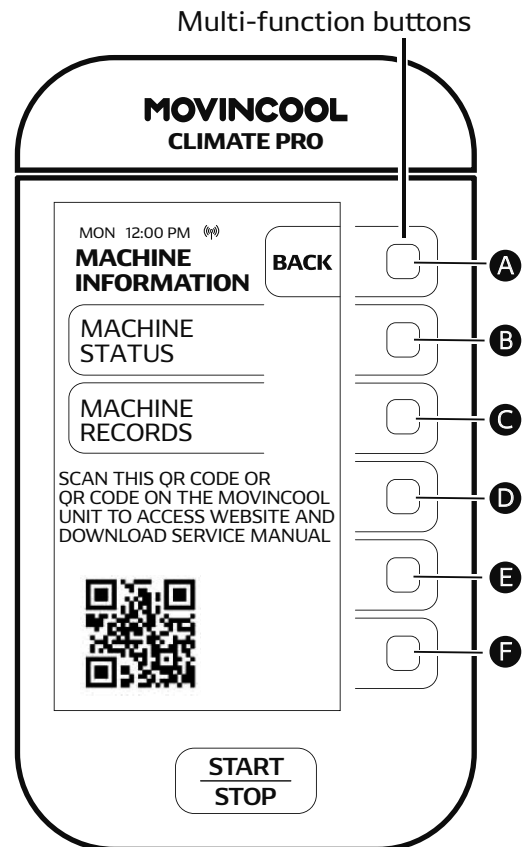

# SERVICE INFORMATION

- After pressing **B** on the MACHINE INFORMATION screen, MACHINE STATUS screen is displayed. If you wish to return to the HOME screen, press **A** repeatedly until the HOME screen is displayed.

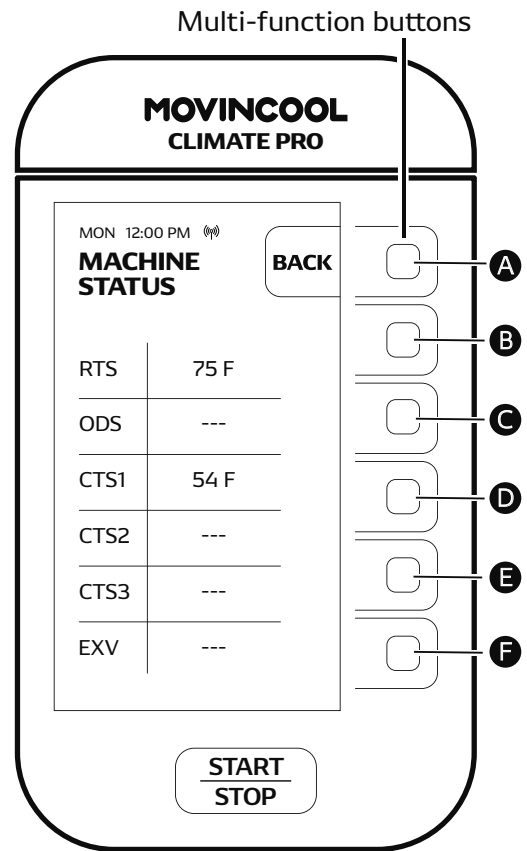

- After pressing **C** on the MACHINE INFORMATION screen, MACHINE RECORDS screen is displayed. If you wish to return to the HOME screen, press **A** repeatedly until the HOME screen is displayed.

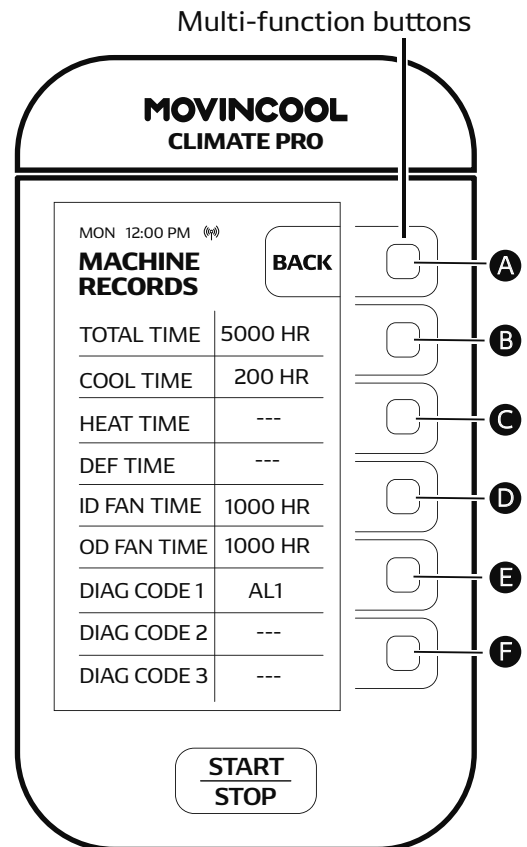

# SELF-DIAGNOSTIC CODES

1. If a self-diagnostic code is displayed, follow the on-screen instructions.
2. If CLEAR is shown, press **F** to reset.  
The HOME screen will be shown.  
Refer to "List of Self-diagnostic codes" on the next page.

Note:

- If a self-diagnostic code is displayed again after following the instructions, contact dealer or qualified technician.

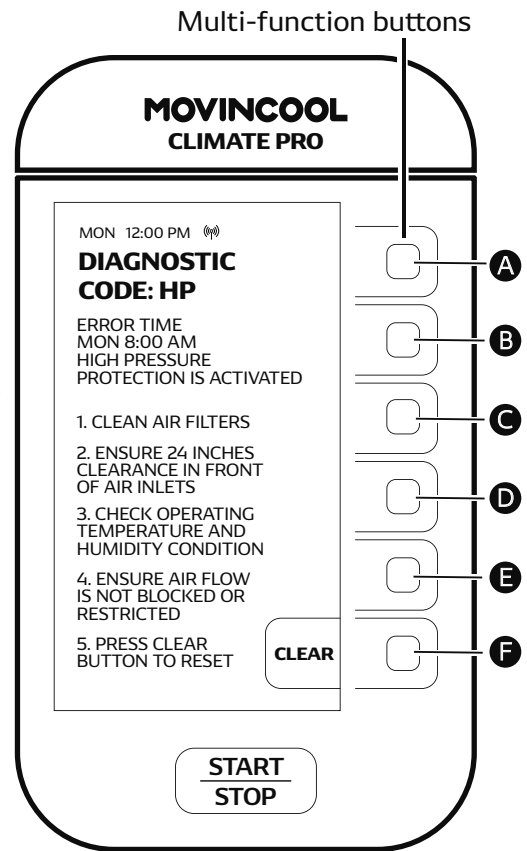

## LIST OF SELF-DIAGNOSTIC CODES

CODE	CONDITION	SOLUTION
AL1	Alarm device 1 is activated	<ol style="list-style-type: none"> <li>1. Check FA-1, FA-2 connection</li> <li>2. Identify and correct condition causing alarm</li> <li>3. Press CLEAR button to reset</li> </ol>
AL2	Alarm device 2 is activated	<ol style="list-style-type: none"> <li>1. Check AL-1, AL-2 connection</li> <li>2. Identify and correct condition causing alarm</li> <li>3. Press CLEAR button to reset</li> </ol>
FL	Drain tank is full	<ol style="list-style-type: none"> <li>1. Empty tank</li> <li>2. Place tank back in unit</li> <li>3. Press CLEAR button to reset</li> </ol>
HP	High pressure protection is activated	<ol style="list-style-type: none"> <li>1. Clean air filters</li> <li>2. Ensure 24 inches clearance in front of air inlets</li> <li>3. Check operating temperature and humidity condition</li> <li>4. Ensure air flow is not blocked or restricted</li> <li>5. Press CLEAR button to reset</li> </ol>
PU	Condensate pump error	<ol style="list-style-type: none"> <li>1. Check drain line for kink, blockage and improper routing</li> <li>2. Identify and correct condition</li> <li>3. Press CLEAR button to reset</li> </ol>
CF	Cooling Failure	Contact dealer or qualified technician
E1	RTS thermistor failure	Contact dealer or qualified technician
E2	ODS thermistor failure	Contact dealer or qualified technician
E3	CTS1 thermistor failure	Contact dealer or qualified technician
E4	CTS2 thermistor failure	Contact dealer or qualified technician
E5	CTS3 thermistor failure	Contact dealer or qualified technician

## EMPTYING THE DRAIN TANK

During COOL mode, water accumulates in the drain tank. When the tank becomes full, the self-diagnostic code "FL" is displayed and the unit turns off automatically.

Note:

- If it is necessary to empty the drain tank before it is full, the unit must be turned off before emptying. If SCHEDULE MODE operation is running, stop the operation first. (See page 43)

1. Open the drain tank cover.

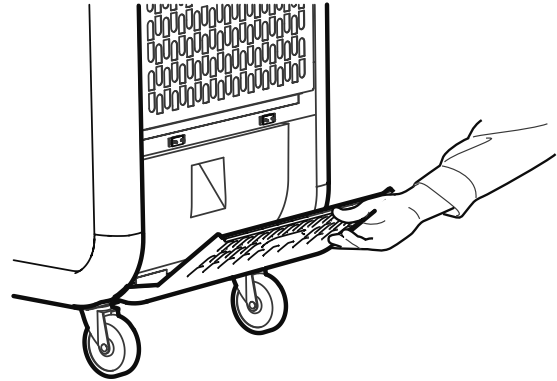

2. Remove the tank.

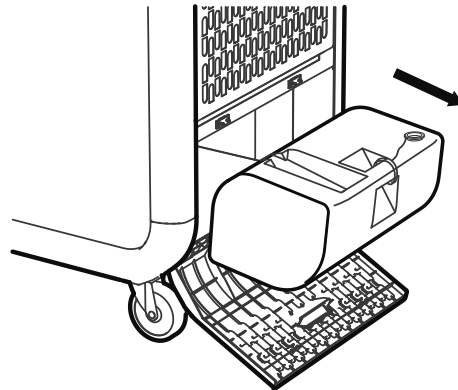

3. Remove the cap and empty the tank.
4. Replace the cap and return the tank to the unit.
5. Close the tank cover.
6. Press CLEAR button to reset the self-diagnostic code.
7. Press  to restart the operation.

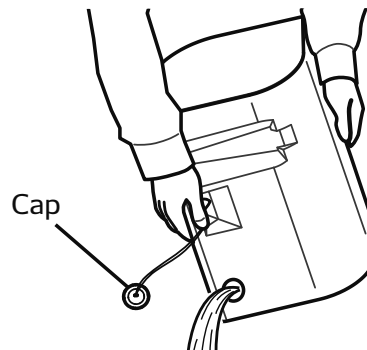

### CAUTION

- When the tank is full, remove water immediately.
- Do not operate without the tank. Ensure that the tank is correctly installed. Water leaks from the unit may cause property damage or injury due to wet floor.



## CONDENSATE PUMP KIT (OPTIONAL ACCESSORY)

Condensate pump kit is available to allow continuous unit operation and eliminate the need for emptying the drain tank.

Note:

- The compressor does not operate while the condensate pump is discharging the water from the reservoir.

### WARNING

- For installation of the condensate pump, consult your MovinCool dealer or qualified technician. Incorrect installation may cause fire, electric shock or water leaks.
- When performing maintenance or troubleshooting, stop the operation and turn off the breaker to avoid causing possible electric shock or injury.

### CAUTION

- Ensure smooth drainage through the hose. If the hose is clogged, it may cause malfunction and property damage due to water leaks.

If a failure occurs, the unit automatically stops and the LCD displays PU. Follow the on-screen instructions.

For optimal performance of condensate pump, follow these instructions:

1. Remove any dirt or debris from the bottom of the reservoir tank.
2. On a monthly basis, check the condensate drain hose for kinks, blockage or any other damage that may prevent the unit from draining properly.
3. Always replace the fan motor cover to keep electrical parts free of dust, dirt and any other foreign material.

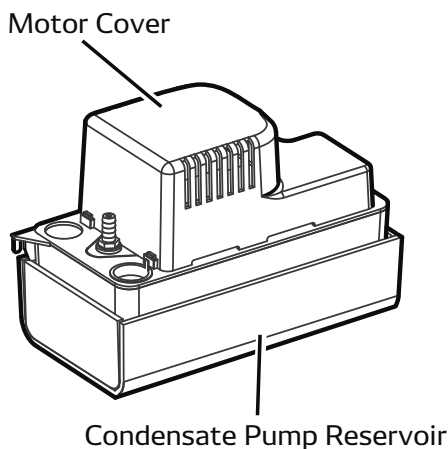

# MAINTENANCE



- When performing maintenance or troubleshooting, stop the operation and remove the power plug. If you touch high-voltage or rotating parts, it may cause electric shock or injury.

## CLEANING AIR FILTERS

Clean air filters once a week. If the unit is used in a dusty environment, more frequent cleaning is required. Dirty air filters will result in poor performance.

1. Turn the unit off by pressing . If SCHEDULE MODE operation is running, stop the operation. (See page 43)
2. Remove front and side panel.

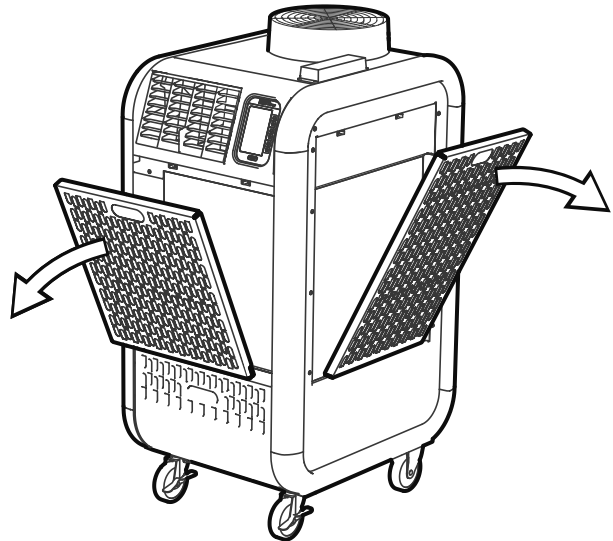

3. Unfasten upper wire frame by moving the two points shown outwards, and then remove filters.

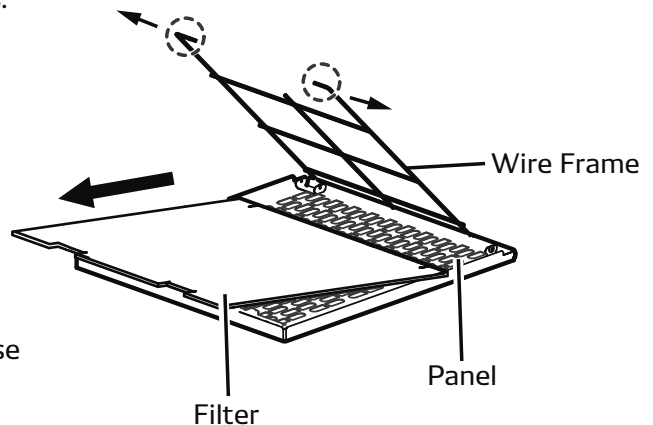

4. Clean off the dust with a vacuum cleaner or rinse in cold or lukewarm water.
5. If necessary, wash with a neutral detergent and rinse with running water.
6. Allow filters to dry in shade, and then reinstall.

## CLEANING THE UNIT

Check plug, power cord, drain tank and hose regularly for damage.



### WARNING

- **Do not wash the unit with water. This may cause fire, electric shock or malfunction. Remove dust from the power plug regularly. Incorrect maintenance may cause fire.**



### CAUTION

- **Wipe the external surface with either a dry cloth or a cloth dampened in a mild cleaner. Using an organic solvent such as benzene or thinner, may crack or scratch the unit which may result in electric shock or injury.**

## BEFORE LONG TERM STORAGE

1. Operate the unit in FAN ONLY mode for 8 hours to dry out the inside completely.
2. Turn the unit off and unplug the power cord.
3. Check the power cord. If dirty, wipe off with a clean dry cloth. If damage or excess play is found on the plug prongs, then contact your MovinCool dealer for power cord replacement.
4. Check the air filters and clean if dirty. Replace if damaged.
5. Check the drain tank and empty the water. Replace if damaged.
6. Check the exterior of the unit. If dirty, clean with a damp cloth or mild nonabrasive cleaner. If any part requires repair or replacement, contact your MovinCool dealer or qualified technician.
7. Store in a clean and dry environment.

# TECHNICAL SPECIFICATIONS

MODEL NAME		CLIMATE PRO K12	CLIMATE PRO K18
Electronic Features	Control	Programmable	Programmable
Cooling Capacity	Rating Conditions: 95°F, 60% RH	12,000 Btu/h	16,800 Btu/h
Electrical Characteristics	Voltage Requirement	115V, 1Phase, 60Hz	115V, 1Phase, 60Hz
	Total Power Consumption	1.2 kW	1.7 kW
	Current Consumption	10.6 amps	15.6 amps
	Recommended Fuse Size	15 amps	20 amps
	NEMA Plug Configuration	5-15	5-20
	Min. - Max. Voltage	104 -127	104 -127
Fans	Motor Output	0.23 kW	0.23 kW
Evaporator	Fan Type	Centrifugal	Centrifugal
	Max. Air Flow (hi/mid/low)	410/380/330 CFM	540/500/440 CFM
	Max. External Static Pressure	0.31 IWG	0.31 IWG
Condenser	Fan Type	Centrifugal	Centrifugal
	Max. Air Flow (hi/mid/low)	760/700/640 CFM	770/710/630 CFM
	Max. External Static Pressure	0.16 IWG	0.23 IWG
Compressor	Type	Hermetic Rotary	Hermetic Rotary
	Output	0.75 kW	0.9 kW
Refrigerant	Type	R-410A	R-410A
Dimensions	W x D x H	22 x 27 x 47 in	22 x 27 x 47 in
Weight	Net / Shipping	166/208 lb	172/209 lb
Power Cord	Gauge	14 AWG (3-core)	12 AWG (3-core)
	Length	10 ft	10 ft
Condensate Tank Capacity		5 gal	5 gal
Operating Conditions	Min.	65°F (@ 50% RH)	65°F (@ 50% RH)
	Max.	95°F (@ 60% RH)	95°F (@ 60% RH)
Max. Duct Length	Per Cold Duct Hose	30 ft	25 ft
	Hot Duct Hose	60 ft	60 ft
Max. Sound Level	With Duct (hi/mid/low)	59/57/53 dB(A)	63/61/59 dB(A)
	Without Duct (hi/mid/low)	61/59/55 dB(A)	65/63/60 dB(A)

Specifications are subject to change without notice.

# TECHNICAL SPECIFICATIONS

MODEL NAME		CLIMATE PRO K24
Electronic Features	Control	Programmable
Cooling Capacity	Rating Conditions: 95°F, 60% RH	24,000 Btu/h
Electrical Characteristics	Voltage Requirement	208/230V, 1Phase, 60Hz
	Total Power Consumption	2.9 kW
	Current Consumption	14.1/13.2 amps
	Recommended Fuse Size	20 amps
	NEMA Plug Configuration	6-20
	Min. - Max. Voltage	198 -253
Fans	Motor Output	0.58 kW
Evaporator	Fan Type	Centrifugal
	Max. Air Flow (hi/mid/low)	650/600/530 CFM
	Max. External Static Pressure	0.51 IWG
Condenser	Fan Type	Centrifugal
	Max. Air Flow (hi/mid/low)	870/760/740 CFM
	Max. External Static Pressure	0.16 IWG
Compressor	Type	Hermetic Rotary
	Output	1.5 kW
Refrigerant	Type	R-410A
Dimensions	W x D x H	22 x 27 x 51 in
Weight	Net / Shipping	205/243 lb
Power Cord	Gauge	12 AWG (3-core)
	Length	6 ft
Condensate Tank Capacity		5 gal
Operating Conditions	Min.	65°F (@ 50% RH)
	Max.	95°F (@ 60% RH)
Max. Duct Length	Per Cold Duct Hose	50 ft
	Hot Duct Hose	45 ft
Max. Sound Level	With Duct (hi/mid/low)	66/64/61 dB(A)
	Without Duct (hi/mid/low)	68/66/63 dB(A)

Specifications are subject to change without notice.

# TROUBLESHOOTING

Review the following before calling your MovinCool dealer or qualified technician.

PROBLEM		POSSIBLE CAUSE	SOLUTION
Unit does not operate	No display on LCD screen	Unit is not connected to power supply	Check connection to mains supply. Try plugging it in
		Main power is off	Check circuit breaker is on
		Ground fault protective breaker is tripped	Reset ground fault protective breaker
		LCDI power cord is tripped	Reset power cord
		LCDI power cord is damaged	Replace power cord
	LCD displays normally, but unit does not start	Ambient temperature has reached set temperature and unit has stopped	Adjust set temperature
Poor cooling performance	Air inlets or outlets are blocked	Keep a minimum clearance of 18 inches (457 mm) from walls or other objects	
	Air filters are dirty	Clean air filters	
	Temperature setting is too high	Adjust temperature setting	
Water leaking from unit	Tank is not correctly installed	Position tank	
	Tank inlet is clogged	Unclog tank inlet	
	Drain hose has a kink or is blocked	Check and clean drain hose	

# WARRANTY STATEMENT



DENSO PRODUCTS AND SERVICES AMERICAS, INC. ("DENSO") warrants its MOVINCOOL products only to the extent stated in its official written warranties. Unless otherwise specifically provided in writing by DENSO, DENSO warrants to the original end-user that the products shall be free of defects in materials or workmanship and will function in accordance with DENSO's published specifications under ordinary intended use and service for a period listed below beginning from the date of purchase on the invoice to the end-user:

**Model(s): Climate Pro K12, Climate Pro K18, Climate Pro K24**

**Warranty: 3 Years with warranty registration OR 1 Year for unregistered unit**

DENSO shall, at its sole discretion, repair or replace any defective product covered by this warranty. Such remedy shall be end-user's sole remedy with respect to any particular defect in the products.

This warranty does not cover defects or malfunctions which result from causes beyond DENSO's control, including, without limitation, (i) unusual physical or electrical stress; (ii) accident, neglect, abuse, misuse or other abnormal use; (iii) failure to perform routine maintenance in accordance with DENSO's recommended procedures; (iv) normal wear and tear; (v) repairs or attempted repairs by an unauthorized person; (vi) modifications or alterations to the products; (vii) use with parts or devices not supplied or approved by DENSO; (viii) improper installation or service; (ix) shipping damage to any units or spare parts during shipping. This includes and is not limited to compressors, evaporators and condenser coils. This warranty shall extend only to the original end-user and shall be void if any labels or other identifying marks permanently affixed to products when shipped by DENSO are removed, altered, defaced or obliterated.

TO THE EXTENT PERMITTED BY LAW, THIS WARRANTY, AS LIMITED HEREIN, SHALL BE IN LIEU OF AND EXCLUSIVE OF ALL OTHER WARRANTIES, EITHER EXPRESSED OR IMPLIED, ON THE PART OF DENSO PRODUCTS AND SERVICES AMERICAS, INC., OR DENSO CORPORATION, WHETHER ARISING FROM LAW, COURSE OF DEALING, USAGE OF TRADE, OR OTHERWISE, INCLUDING WITHOUT LIMITATION ANY IMPLIED WARRANTY OF MERCHANTABILITY OR FITNESS OF A PARTICULAR PURPOSE OR ANY LIABILITY FOR COMMERCIAL LOSSES BASED UPON NEGLIGENCE OR MANUFACTURER'S STRICT LIABILITY. EXCEPT AS EXPRESSLY PROVIDED HEREIN, NEITHER DENSO PRODUCTS AND SERVICES AMERICAS, INC., NOR DENSO CORPORATION WILL, IN ANY EVENT, BE LIABLE FOR LOST PROFITS, COSTS OF PROCESSING, INJURY, GOODWILL, OR ANY OTHER CONSEQUENTIAL DAMAGES OF ANY KIND ARISING FROM BREACH OF THIS WARRANTY.

DENSO PRODUCTS AND SERVICES AMERICAS, INC. reserves the right to make changes without prior notice.

# DATA PRIVACY DISCLOSURE

## Tracking of Machine Operation Data

This Unit is equipped with an embedded module that collects and transmits to us data on the Unit's operational performance ("Machine Operation Data"), including:

1. Hours of operation
2. Control Panel settings
3. Ambient Temperature
4. Error Codes
5. Geolocation

## How We Use the Data We Collect

The embedded module collects the Machine Operation Data in a format that is used for business analysis purposes, and does not identify the user. However, Machine Operation Data may become personal information about an identifiable individual when it is read together or combined with other personal information.

We use the Machine Data to:

- (i) Monitor the performance of the Unit.
- (ii) Analyze the performance of the Unit under actual environmental conditions.
- (iii) Analyze the performance of the Unit under actual user demand conditions.
- (iv) **Locate the Unit.**
- (v) Use aggregate data to enhance the performance, efficiency and usefulness of our products.
- (vi) Use aggregate data to modify, improve or develop new products, services and technologies.
- (vii) Comply with legal, regulatory or contractual requirements.

When you purchase or lease a Unit from us or one of our authorized distributors or resellers, we may obtain personally identifying information about you such as your name, address, phone number and e-mail address ("Personally Identifying Information"). We and our authorized distributors or resellers may use Machine Operation Data together with Personally Identifying Information to:

- (i) Assist in trouble shooting and repair.
- (ii) Provide any safety updates or recall notices.
- (iii) Provide warranty service.
- (iv) Provide and improve customer support.
- (v) **Locate the Unit.**

The Machine Operation Data will be transmitted to us in the United States. While Machine Operation Data is in the United States it may be accessed by the courts, law enforcement and national security authorities pursuant to local U.S. laws.

## Sharing of Data

We shall use Machine Operation Data primarily for our own business purposes. We may also share your Unit's Machine Operation Data with the distributor, reseller or owner that sells or leases the Unit to you. This means that they will be able to determine the geolocation of the Unit.

We may disclose Machine Operation Data to a third party service provider in the United States for processing in order to analyze the performance of the Units and make improvements. The third party service provider is contractually bound to use Machine Operation Data solely for the purpose of providing services to us and not for their own purposes.



# DATA PRIVACY DISCLOSURE

## How Long We Keep Your Information

We may keep the information we collect for as long as necessary to provide products or services to you, to operate our business, to enable us to communicate with you, for our safety, research, evaluation of use, or troubleshooting purposes, or to satisfy our legal or contractual obligations. Where required, we will de-identify or dispose of the information we collect when we no longer need it for the uses described above.

## **CONSUMER RIGHT TO “OPT OUT” OF DATA SHARING**

If you are a consumer and you do not want us to provide your Unit’s Machine Operation Data, including the Unit’s geolocation, or your Personally Identifying Information to your supplying distributor, reseller or owner, you may “Opt Out” by contacting us at 1-800-264-9573 or [www.movincool.com](http://www.movincool.com)

If you are a consumer and you do not want us to use a third party service provider to process your Unit’s Machine Operation Data, you may “Opt Out” by contacting us at 1-800-264-9573 or [www.movincool.com](http://www.movincool.com)

## **CONSENT TO OUR COLLECTION, USE AND DISCLOSURE OF MACHINE OPERATION DATA**

By reading this notice and using this Unit, you consent to our collection, use and disclosure of Machine Operation Data. If you do not wish to give your consent, we will disable the Machine Operation Data tracking module upon request at 1-800-264-9573 or [www.movincool.com](http://www.movincool.com)

## **CONSENT TO OUR COLLECTION, USE AND DISCLOSURE OF GEOLOCATION DATA**

By reading this notice and using this Unit, you consent to our collection, use and disclosure of geolocation data. If you do not wish to give your consent, we will disable the Machine Operation Data tracking module upon request at 1-800-264-9573 or [www.movincool.com](http://www.movincool.com)

The tracking of geolocation data is an integral function of the Machine Operation Data tracking module. Therefore, disabling the geolocation functionality will disable all other functionality of the Machine Operation Data tracking module. If the Machine Operation Data tracking module is disabled, we will not be able to provide you with any accompanying customer service enhancements.

## **CONSUMER RIGHT TO WITHDRAW CONSENT**

If you no longer wish to consent to our use, collection and disclosure of Machine Operation Data, you may contact us at 1-800-264-9573 or [www.movincool.com](http://www.movincool.com) and we will disable the Machine Operation Data tracking module.

For further information about our privacy policy or our privacy management practices, please refer to [www.movincool.com](http://www.movincool.com)

***DENSO***

DENSO PRODUCTS AND SERVICES AMERICAS, INC.

Long Beach, CA 90810  
[www.movincool.com](http://www.movincool.com)