

INSTALLATION INSTRUCTIONS

main burner/pilot assembly replacement

gas-fired unit heaters and duct furnaces

6A Standing Pilot

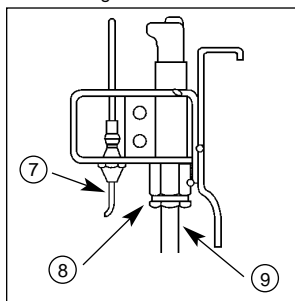

6B Automatic Pilot with separate igniter and sensor

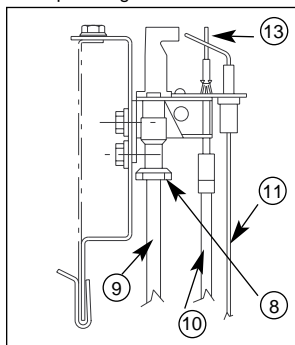

6C Automatic Pilot with combined igniter and sensor

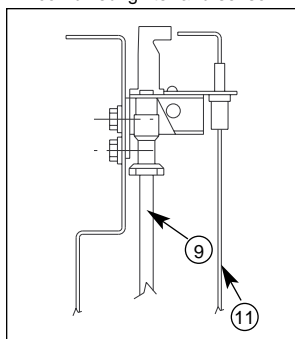
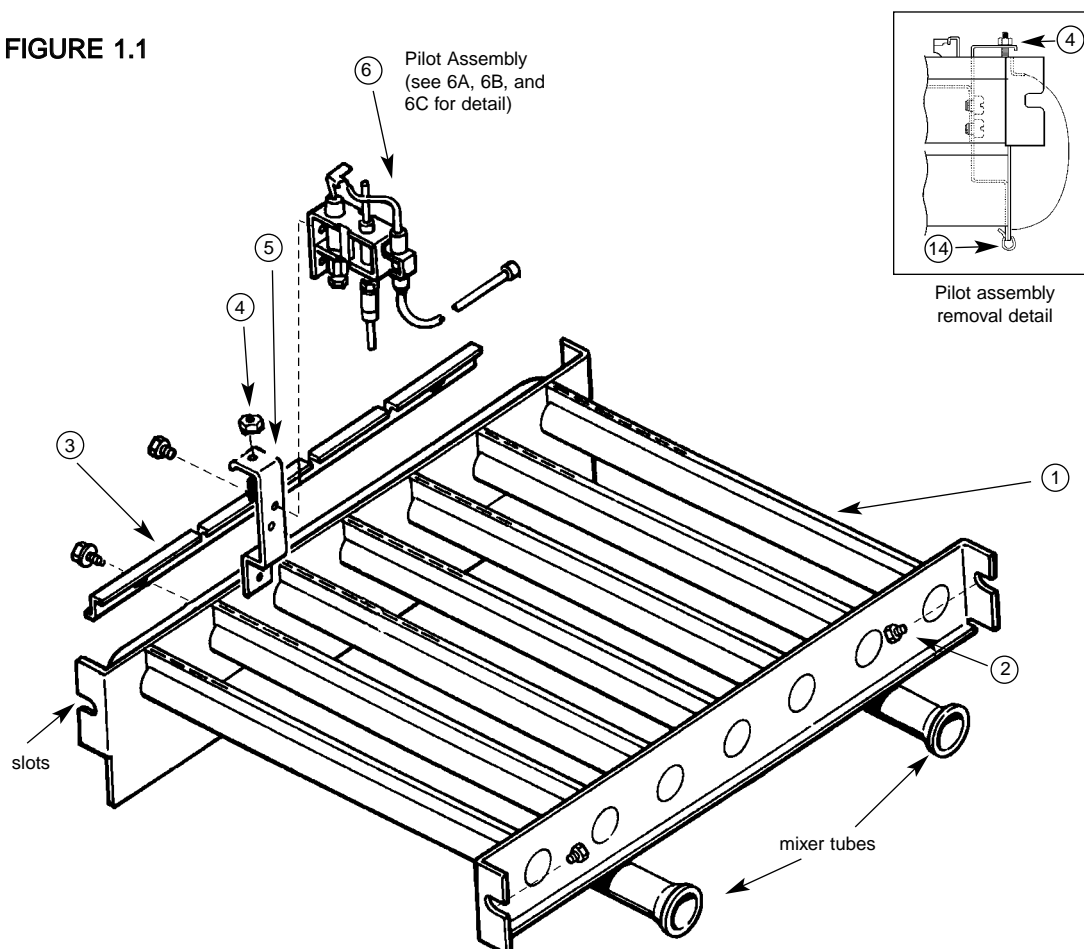

FIGURE 1.1



CAUTION

1) This replacement kit comes equipped for use with Natural Gas. For use with Propane Gas, install pilot orifice according to Table 2.1 on back page. 2) There will be some differences relative to access of the burner in conventional gas unit heaters versus separated combustion. The replacement procedure, however, is the same.

IMPORTANT

The use of this manual is specifically intended for a qualified installation and service agency. All installation and service of these units must be performed by a qualified installation and service agency. Modine manuals may contain excerpts from component supplier literature adapted for Modine products. Any accompanying component supplier literature is for general information.

General Information

To provide standard pilot locations for all gas-fired unit heaters, the pilot assembly is mounted directly on the carryover strip on the burner, as illustrated in figure 1. Different pilot assemblies illustrated in insets are: (6A) standing pilot controlled by thermocouple, (6B & 6C)

intermittent duty pilot ignited with a spark-type igniter. Pilot assemblies for service replacement do not include thermocouples or sensing probes. Use the following replacement instructions to assure long-lasting and reliable burner/pilot service.

Main Burner Removal

1. Turn off electricity and gas to unit.
2. Lower bottom pan.
3. Disconnect pilot tubing at combination gas control (CGC) (gas valve).
4. If standing pilot (6A), disconnect thermocouple lead (7) at CGC. If automatic pilot (6B or 6C), disconnect ignition wire (11) and sensor wire (10) (if so equipped) at ignition control.
5. Remove the two burner retaining pins (2) holding the main burner (1) in place. The main burner can then be easily lowered from the unit.

Pilot Assembly Removal

1. Remove nut (4) and speed clip (14) holding the pilot locating bracket (5) to carryover strip (3).
2. Slide pilot locating bracket (5) off of stud on carryover strip (3) and remove pilot assembly (6) through bottom of main burner (1).
3. **If standing pilot (6A)**, remove and save thermocouple (7) from pilot burner.

Carryover Strip Removal

1. Remove Screws holding carryover strip (3)

Carryover Strip Reassembly

1. Position carryover strip (3) so holes in strip line up with holes in main burner (1). Use stainless steel screws provided to attach.

CAUTION

Do not overtighten screw. Overtightening can cause poor ignition that results in flashback noise and flame rollout.

Pilot Assembly Reassembly to Main Burner

1. Check that correct pilot orifice is used. A pilot burner sent as part of the pilot assembly replacement kit has a pilot orifice for natural gas installed. Refer to Fig. 2.1 to identify the manufacturer of the pilot burner. On a Johnson Pilot Burner (2A) the orifice can be identified without disassembly, but for Robertshaw (2B) and Honeywell (2C) pilot burners, the pilot orifice must be removed to identify.
2. To remove pilot orifice (12), loosen the nut (8) holding the pilot tubing (9) to pilot burner. The pilot orifice is now loose but may require a tap to get it out.
3. All pilot orifices (12) have an identity number stamped on them. See pilot burner drawings (Fig. 2) for location. The identity number for natural and propane gas are in Table 2.1
4. Install pilot orifice (12) and connect pilot tubing (9) to pilot burner with compression sleeve and nut (8) provided. Tighten firmly.
5. If not already done attach pilot burner to pilot locating bracket (4) with screws provided. Tighten firmly.
6. **If standing pilot (6A)**, install thermocouple (7) into pilot burner making sure it snaps into place (some



replacement thermocouples have retaining nuts that should be tightened firmly). **If automatic pilot**, with separate igniter and sensor (6B), install flame sensor (13) making sure it snaps into place. Attach sensor wire (10) to flame sensor (13), using end with plastic cover over terminal.

7. Move pilot assembly into position by approaching from bottom of main burner. Slide hole in pilot locating bracket (5) over stud on carryover strip (3).
8. Attach nut (4) and tighten firmly while holding pilot assembly to prevent rotating. Attach speed clip (14) to hold bottom of pilot locating bracket (5) in place.

Main Burner Reassembly to Unit

1. Position main burner (1) in unit. Be certain that the slots at the front of the burner are located properly on their shoulder rivets. Install the two burner retaining pins (2) making sure they snap into place. Double check to see that burner ports are lined up directly in center of heat exchanger tubes.
2. **If standing pilot**, connect thermocouple lead to CGC (gas valve). **If automatic pilot** with combined igniter and sensor, attach ignition wire (11) to "SPARK" terminal of ignition control. If there is a separate igniter and sensor, attach ignition wire (11) (thinner wire) to "IGN" terminal and sensor wire (10) (thicker wire) to "SENSE" terminal of ignition control.
3. Connect pilot tubing to CGC. Tighten firmly.
4. **If standing pilot**, on CGC move control knob or lever to pilot. **If automatic pilot**, remove wire from "MV" terminal of ignition control (will prevent gas from going to main burner).
5. Turn on electricity and gas.
6. **If standing pilot**, light the pilot. **If automatic pilot**, turn thermostat up to light pilot.
7. Check for gas leaks from pilot tubing at the CGC and the pilot burner.
8. Turn thermostat down.
9. **If standing pilot**, on CGC move control knob or lever to on. **If automatic pilot**, turn off electricity, reconnect wire to "MV" terminal of ignition control, turn on electricity.
10. Turn thermostat up, main burner should come on. Observe pilot flame and main burner flame. Refer to proper Installation and Service Manual for pilot flame adjustment, main burner flame control and troubleshooting.
11. Return bottom pan into position and secure with two retaining screws.
12. Set thermostat at desired setting.

TABLE 2.1 - Pilot Orifice Identity Numbers

Pilot Burner Manufacturer	Identity No. Natural Gas	Identity No. Propane Gas
Honeywell	BCR-18	BBR-11 or -12
Robertshaw		
Johnson	7715	4710

① As number appears on top of pilot orifice.

FIGURE 2.1 - Pilot Burner

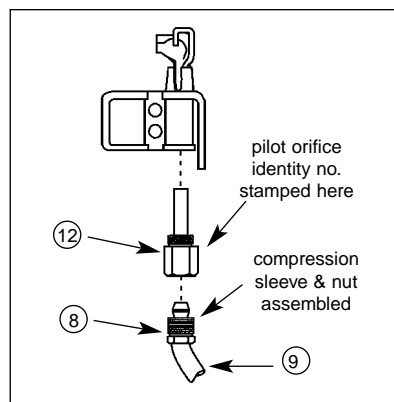

2A
Johnson

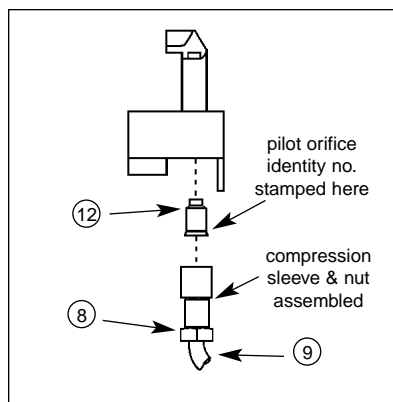

2B
Robertshaw

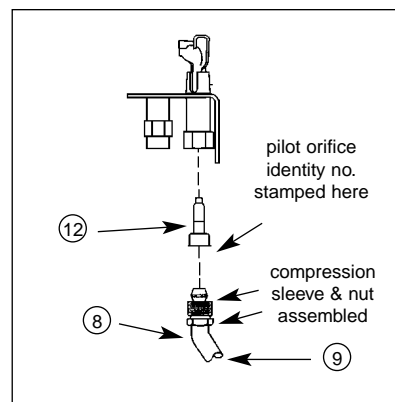

2C
Honeywell