

INSTALLATION AND MAINTENANCE



Smart Heating Solutions

LPW ECO2S PRO

7-Day Programmable 2-Stage Electronic
W/ Remote Temperature Sensing Controller



ECO PRO Controller
7-Day Programmable Remote
Temperature Sensing Controller

Figure 1-1

Covers all LPW-ECO PRO models

DANGER

ELECTRIC SHOCK OR FIRE HAZARD

READ ALL WIRE SIZING, VOLTAGE REQUIREMENTS AND SAFETY DATA TO AVOID PROPERTY DAMAGE AND PERSONAL INJURY

WARNING

READ CAREFULLY - Use the heater only as described in this manual. Any other use is not recommended and could result in fire, electric shock, and personal injury. Following these instructions will prevent difficulties that might occur during the installation and use of the heater. Please study the instructions first, as they may save considerable time and trouble during use in addition to providing important safety information. Make sure to save these instructions for future use.

- WARNING** 1. Read all instructions before wiring or using this heater.
- WARNING** 2. This heater is hot when in use. To avoid burns, do not let bare skin touch hot surfaces. Keep combustible materials, such as furniture, pillows, bedding, papers, clothes, boxes, etc., and curtains at least 3 feet away from the front and sides of heater.
- WARNING** 3. Extreme caution is necessary when any heater is used by or near children or invalids and whenever the heater is left operating and unattended.
- WARNING** 4. Do not operate any heater after it malfunctions. Disconnect power at service panel and have heater inspected by a qualified electrician for repair before reusing.
- WARNING** 5. Do not use outdoors.
- WARNING** 6. To disconnect heater, turn controls to OFF, and turn OFF power from main service panel.
- WARNING** 7. Do not insert or allow foreign objects to enter any ventilation or exhaust opening as this may cause an electric shock, fire, or damage to the heater.
- WARNING** 8. To prevent a possible of fire, do not block air intakes or exhaust in any manner.
- WARNING** 9. A heater has hot and arching or sparking parts inside. Do not use it in areas where gasoline, paint, or any other flammable vapors or liquids are stored.
- WARNING** 10. Use this heater only as described in the manual. Any other use is not recommended by the manufacturer and may cause fire, electric shock, explosion or injury to people and or property.
- WARNING** 11. This heater includes a Smart limit protection that shuts down heater in the event of excessive over heating.

Figure 1-2



HEATER DIP SWITCH SETTINGS

In order for your heater to be recognized and pair with the ECO PRO Controller, Dip Switch #1 on the back of the Heater display must be set to OFF. Once set to OFF the heater will be able to receives signals from the ECO Pro Controller.



LPW EC02S PRO INSTALLATION INSTRUCTIONS

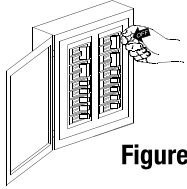

CAUTION!
Turn OFF all electrical power to install heater

Figure 2-1

DANGER

ELECTRIC SHOCK OR FIRE HAZARD

READ ALL WIRE SIZING, VOLTAGE REQUIREMENTS AND SAFETY DATA TO AVOID PROPERTY DAMAGE AND PERSONAL INJURY

Figure 2-2

Rating Label Location

ALL WARRANTIES ARE VOID IF THIS HEATER IS USED DURING CONSTRUCTION FOR HEATING.
King Electrical Mfg. Seattle Wa. LISTED
 Do Not Install Less Than 6" From Vertical Side Walls. Install Bottom Of Heater Not Less Than 4" Above The Finished Floor. The Electrical Power To The Heater Is To Be Disconnected Before The Grill Is Removed For Cleaning. Do Not Operate The Heater With Grill Removed. For Use With Wallbox LPWAU200G.
 Installer La Partie Inferieure Du Radiateur Au Moins A 100mm Au-dessus Du Plancher Fini.
MODELE: P14724E7 WATTS:4000 VOLTS: 277
 CIRCLE MAXIMUM WATTS THIS HEATER IS WIRED FOR
277 VOLT:4000-3000-2000-1000
MADE IN U.S.A



Figure 2-3

INSTALLATION LOCATION AND CLEARANCES

Selecting a location for your heater:

Do Not Install Less Than 6 inches From Vertical Side Walls. Do Not Install Less Than 4 in. from the Floor and 12 in. from ceiling.

This heater must have an unrestricted airflow. Do Not select a location where it is likely to be blocked by furniture, curtains, etc.

Be sure the location selected allows sufficient space for the heater as shown below by Table 1. Do Not locate this heater in an area where combustible vapors, gases, flammable liquids, or excessive lint, dust or moisture is present.

Table 1

Minimum Clearances for heater:			
Front	TOP	BOTTOM	SIDES
36 in	12 in	4 in	6 in
0.9 m	30.5 cm	10.2 cm	15.2 cm

Zero clearance to insulation.

The wire and breaker sizing chart will give a general rule of installation size. Consult an electrician if you are not knowledgeable about wiring codes.

Wire and Breaker Sizing:

WIRING: Branch Circuit Connection

Table 2

Total Amps	Minimum AWG. Wire Size (Copper)	Circuit Breaker or Fuse Size
0 thru 12	#14	15 amp
12.1 thru 16	#12	20 amp
16.1 thru 24	#10	30 amp

Product Dimensions

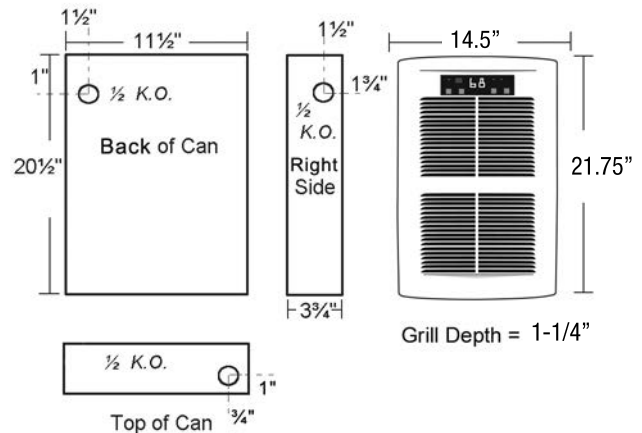

WIRING AND INSTALLATION

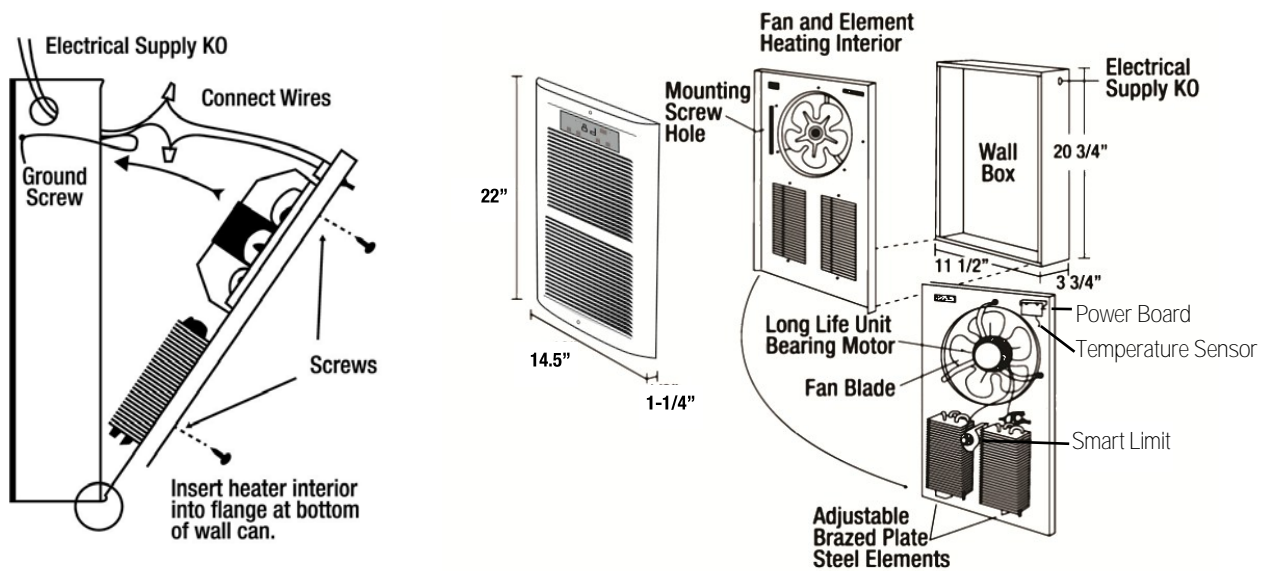

1. Connect heater only to the voltage, amperage and frequency specified on the nameplate.
2. Wiring procedures and connections shall be in accordance with all National and local codes having jurisdiction.
3. Set the bag containing the grill and packet with (2) grill screws aside.
4. Loosen grill screws and as you slowly remove grill disconnect the quick connectors on the LCD patch cable so grill can be completely removed from heater.
5. Loosen interior fan heater assembly mounting screws (4) and remove fan heater assembly.
6. A knockout of 1/2 inch conduit size (7/8 inch) is provided in the back and side of the heater for power to enter. Provide proper strain relief connectors (not included) for your wire entering the wall box.
7. Install wall box a minimum of 6 inches from vertical side walls and 4 inches above floor.
8. Secure wall box to the 2 x 4 studs using the (2) holes on the side of the wall box. Secure to wall stud on opposite side if required.
9. Make final High and Low wattage selections. See page 4 for details.
10. Connect supply wires, attach ground feed wire to the green ground wire with wire nuts.
11. Reinstall heater assembly into wall box with screws (4).
12. Reinstall grill following the opposite steps of removal. Connect LCD display patch cable by securing quick connectors together and secure grill with provided screws. Do Not over tighten.
13. Test unit by turning thermostat up past room temperature. You may see a puff of smoke as the elements are energized and the fan turns on. This is a normal burn off of manufacturing lubricants and will dissipate in 5 minutes.
14. For full operating details refer to Operating Instructions on page 6.

WATTAGE SELECTION

Model: LPW2045-ECO (208V 4500W Max)

Model: LPW2445-ECO (240V 4500W Max)

The heater is factory wired to 4500 Total Watts at 208/240 Volts (4500 Watts Stage 1 - HIGH / 2750 Watts Stage 2 - ECO). To change the heater's Stage 1 and Stage 2 wattages, unplug insulated push-on terminals from the elements per the chart below and wrap with electrical tape to prevent possibility of electrical contact with element & other parts.

Element # 1	Red Wire	Disconnects 1000 Watts
	Blue Wire	Disconnects 750 Watts
	Orange Wire	Disconnects 500 Watts
Element # 2	Black Wire	DO NOT DISCONNECT (Common)
	Purple Wire	Disconnects 1000 Watts
	Yellow Wire	Disconnects 750 Watts
	Brown Wire	Disconnects 500 Watts
	Black Wire	DO NOT DISCONNECT (Common)

END VIEW OF ELEMENT #1

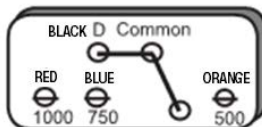

END VIEW OF ELEMENT #2

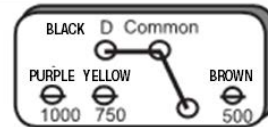

HEATING STAGES		ELEMENT TERMINATIONS			
		CONNECT		DISCONNECT	
STAGE 1 - HIGH HEAT	STAGE 2 - ECO	Element #1	Element #2	Element #1	Element #2
4500 Watts	2750 Watts	RED + BLUE + ORANGE	PURPLE + YELLOW + BROWN	-	-
4000 Watts	2250 Watts	RED + BLUE	PURPLE + YELLOW + BROWN	ORANGE	-
3500 Watts	2700 Watts	RED + BLUE + ORANGE	YELLOW + BROWN	-	PURPLE
3000 Watts	2250 Watts	RED + BLUE	YELLOW + BROWN	ORANGE	PURPLE
2500 Watts	1750 Watts	BLUE + ORANGE	YELLOW + BROWN	RED	PURPLE

Model LPW1227-ECO (120V 2750W Max)

The heater is factory wired to 2750 Total Watts at 120 Volts (2750 Watts Stage 1 - HIGH / 1500 Watts Stage 2 - ECO). To change the heater's Stage 1 and State 2 wattages, unplug insulated push-on terminals from the elements per the chart below and wrap with electrical tape to prevent possibility of electrical contact with element & other parts.

Element # 1	Red Wire	Disconnects 750 Watts
	Blue Wire	Disconnects 500 Watts
	Orange Wire	Disconnects 250 Watts
	Black Wire	DO NOT DISCONNECT (Common)
Element # 2	Purple Wire	Disconnects 750 Watts
	Yellow Wire	Disconnects 500 Watts
	Brown Wire	Disconnects 250 Watts
	Black Wire	DO NOT DISCONNECT (Common)

END VIEW OF ELEMENT #1

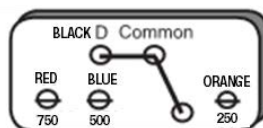

END VIEW OF ELEMENT #2

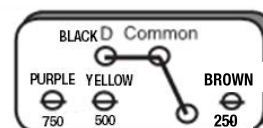

HEATING STAGES		ELEMENT TERMINATIONS			
		CONNECT		DISCONNECT	
STAGE 1 - HIGH HEAT	STAGE 2 - ECO	Element #1	Element #2	Element #1	Element #2
2750 Watts	1500 Watts	RED + BLUE + ORANGE	PURPLE + YELLOW	-	-
2500 Watts	1750 Watts	RED + ORANGE	PURPLE + YELLOW + BROWN	Blue	-
2250 Watts	1500 Watts	RED	PURPLE + YELLOW + BROWN	BLUE + ORANGE	-
2000 Watts	750 Watts	RED + BLUE	YELLOW + BROWN	ORANGE	PURPLE
1750 Watts	1250 Watts	RED + BLUE	YELLOW	ORANGE	PURPLE + BROWN
1500 Watts	1000 Watts	BLUE + ORANGE	YELLOW + BROWN	RED	PURPLE

SETUP OF ECO PRO CONTROLLER

A wireless 7-Day Programmable Temperature Sensor Controller (ECO PRO Controller) is provided to allow programming a 7-Day heating schedule and also to monitor the ambient temperature from any remote location. It needs to be paired with the heater prior to operation.

ECO PRO Controller Placement

Important: Avoid areas that can have temperature extremes, making the ECO PRO Controller think the room is cooler or warmer than it actually is. Don't install the ECO PRO Controller near doors that could let in drafts, or on exterior walls or near windows in direct sunlight.

Product Overview

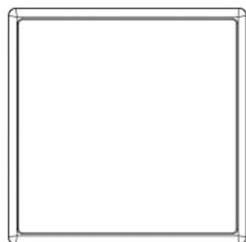

Front View



Side View

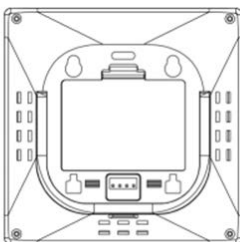

Back View

PRO CONTROLLER:

IMPORTANT: The ECO PRO Controller must be paired to the heater prior to use. If heater display shows "L5" the ECO PRO Controller has not been paired successfully. Repeat Pairing Process.

Technical Specifications:

Protocol: Wireless 2.4G
 Transmit Distance: 98'
 Working Voltage: DC 3V (battery);
 Control Range: 40° to 95°F

Control Panel

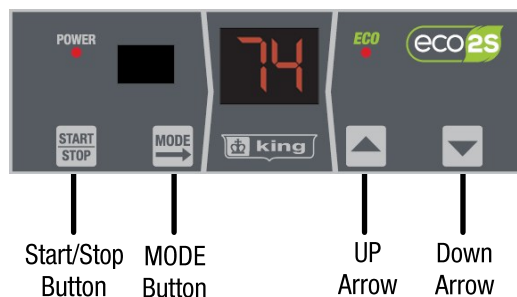

PAIRING AND USAGE GUIDE

Since it is possible that more than one heater/ECO PRO Controller would be used in a home, you must first pair the PRO Controller to a specific heater. Each ECO PRO Controller has a unique ID number, which will be used in the pairing process. When installing the PRO Controller first time, users need to pair the ECO PRO Controller with the heater, so the heater can learn and save the remote sensor's ID.

Step 1: On the Heater's Display Press and button at the same time for 5 seconds. The LED display will flash "id". Release buttons.

Step 2: Put the ECO PRO Controller within 3 feet of the heater and then press and hold the button to enter pairing mode.

Step 3: The icon will appear on the ECO PRO Controller, and the heater's display indicator lights will illuminate (LED tubes show 88) for 1 second and then turn off. This means the ECO PRO Controller and the heater have paired with each other successfully.

NOTE: If the LPW display flashes "id" for 20 seconds and then turns off, it means that the heater failed to pair with the ECO PRO Controller and has exited the Pair mode. Repeat the above steps to pair the remote sensor.

Step 4: After pairing the ECO PRO Controller successfully, put the ECO PRO Controller in the room where you want to detect temperature. The LPW heater display will now display the temperature from the remote sensor. Note: See page 14 for pairing instructions for multiple heaters to a single ECO PRO Controller.

Installing Batteries

Open the battery cover and insert 3pcs AAA batteries, reinstall the battery cover.

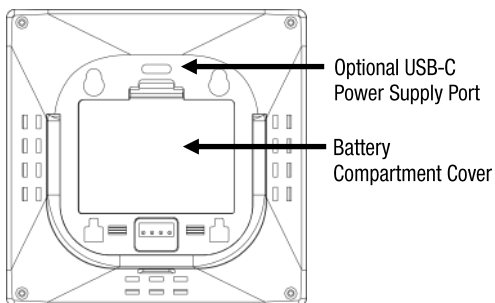

Optional USB-C Power Supply Port
 Battery Compartment Cover

Wall Mounting The ECO PRO Controller

ECO PRO Controller can be placed on any flat surface or can be fixed to the wall with the mounting bracket. **Mounting Bracket Install:** Select location for the ECO PRO Controller on the wall. Secure the bracket to with 2 appropriate anchors and screws. Insert ECO PRO Controller into bracket.

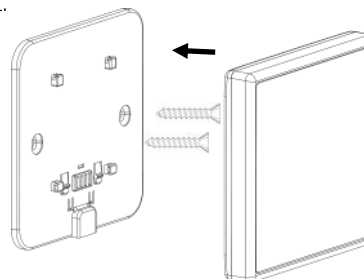

Low Battery Indicator

When batteries are low, "BA" will flash on the LPW heater display and icon appears on the Pro Controller to indicate batteries should be replaced.

Note: If batteries fail, the LPW is designed to revert back to the onboard temperature sensor for temperature control until the batteries are replaced in the remote sensor.

Low Signal Indicator

When the ECO PRO Controller is not paired with the heater or if the signal is being blocked. the display flashes "L5". After 10 minutes, the controller will automatically switch to work with the on-board temperature sensor, but the display will continue to flash "L5" until the signal is restored.

1. Follow Pairing process above to successfully pair the sensor.
2. Move ECO PRO Controller closer to the heater or away from metal objects that might block the signal.

INITIAL SETUP OF ECO PRO CONTROLLER

INITIAL SETUP:

Press and hold  and  buttons for 5 seconds to enter SETTINGS steps:

Setting#1: Set °Celsius or °Fahrenheit

Press  or  to select °C or °F (Default °F).

Press  to save setting and move to next step.

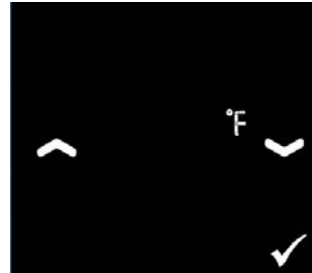

Setting °C or °F

Setting#2: Set Clock

Press  or  to adjust Day → Hour → Minute.

Press  to save setting and move to next step.

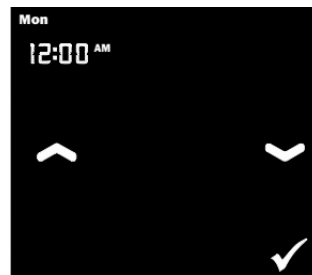

Setting Clock

Setting#3: Set Temperature Offset:

The Offset value that you set will be added or subtracted from the ambient temperature reading shown on the display. This can be useful to match other temperature reading devices in the space.

Press  or  to adjust the Temperature Offset. (Range -4°F to +4°F)

Press  to save setting and move to next step. (Default 0°F)



Setting Temperature Offset

Setting#4: Set Brightness:

Press  or  to select the screen's contrast level from 1 (Dimmest) to 7 (Brightest).

Press  to save setting and exit initial setup. (Default 5)



Setting Brightness

INITIAL SETUP OF ECO PRO CONTROLLER - Cont.

Setting#5: System OFF or Freeze Protection OFF:

This option sets the preferred setting when the  button is pressed.

Press  or  to select between System OFF or Freeze Protection OFF

Press  to save setting and move to next step.

System Off = Disables the relay output and heater will never turn on under any scenario.

When activated  is shown on display.

Freeze Protection Off = Heater will turn on if the ambient room temperature drops below 40F.

When activated  is shown on display.

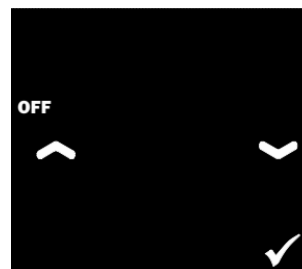

System Off

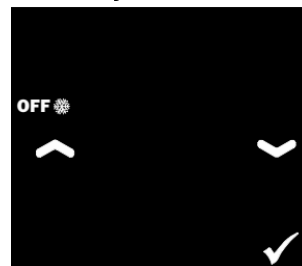

Freeze Protection Off

Setting#6: WINDOW OPEN SETBACK Temperature (Optional Window/Door Sensor Accessory Required)

Select the preferred setback temperature if an optional Window/Door sensor is connected to system. See page 16 & 19 for additional details.

Press  or  to select between 40°F (default), 45°F, 50°F, or 55°F.

Press  to save setting and move to next step.

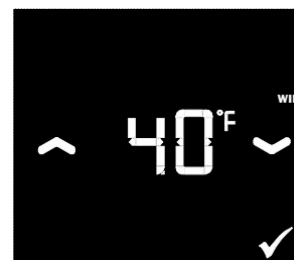

Window Open Setback

Setting#7: PIR UNOCCUPIED SETBACK Temperature (Optional PIR Occupancy Sensor Accessory Required)

Select the preferred setback temperature if an optional PIR Occupancy Sensor is connected to system. See page 17 & 20 for additional details.

Press  or  to select between 45°F, 55°F, 60°F (default), or 65°F.

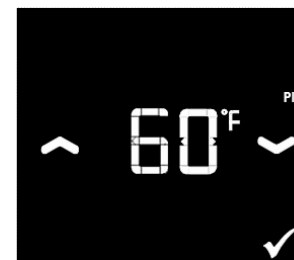

Press  to save setting and exit initial setup.



PIR Unoccupied Setback

Setting#8: MULTIPLE HEATER INSTALLATION SCENARIO (SAME ROOM OR DIFFERENT ROOMS)

Since the ECO PRO Controller can be paired to multiple heaters, the status of each heater will be different under these two scenarios. This option sets the control logic depending if multiple heaters are installed in a single room or different rooms. See page 14 for details.

Press  or  to select between 1 = Same Room (Default) or 0 = Different Rooms.



Press  to save setting and exit initial setup.

Note: At any time during the setup process you can Press and Hold the  button for several seconds to exit the initial setup early.

OPERATION OF ECO PRO CONTROLLER

PRESET SCENE TEMPERATURES:

ECO PRO Controller has 3 preset scene temperatures that you can quickly select to temporarily override the heating schedule when your daily routine unexpectedly changes. Their default settings are shown in the following table:

Scene	Icon	Default Temp Settings
Home		70°F
Away		55°F
Sleep		60°F

HOW TO USE A PRESET SCENE:

Press the Preset Scene Temperature Icon  until it starts flashing. With each additional press it will switch between the 3 preset scenes.

Once the Scene you desire is shown, Press  to save Preset Scene.

That preset temperature becomes the current setpoint until the next Heat Schedule period starts when the heater returns to the programmed heating schedule.



MODIFYING A PRESET SCENE TEMPERATURE:

Press the Preset Scene Temperature Icon  until it starts flashing. With each additional press it will switch between the 3 preset scenes.

Once the Scene you desire to modify is shown, Press  or  to adjust the temperature setpoint for that scene until the new desired setpoint temperature is shown.

Press  to save the new setpoint for the Preset Scene.

Note: This becomes the new setpoint, not only for the Preset Scene but also throughout your heating schedule where that scene is used.

PROGRAMMING THE HEATING SCHEDULE

DEFAULT HEATING SCHEDULE:

The ECO PRO Controller uses the PRESET SCENE TEMPERATURES setpoints (as described on page 8) as the temperature setpoints for the time period in your heating schedule. The default heating schedule is shown in the following table. We recommend using the default schedule since it was designed to help reduce your heating expenses.

The schedule consists of 4 periods per day, which represents a typical work day.





The HOME  preset temperature is automatically used in Periods 1 and 3.

The AWAY  preset temperature is automatically used in Period 2.

The SLEEP  preset temperature is automatically used in Period 4.

You can have a different schedule for every day; i.e., each period can start at a different time every day.









The ECO PRO Controller has been factory programmed with the following schedule.

Period	Icon	Scene	Mon	Tue	Wed	Thr	Fri	Sat	Sun
①		Home	6:00 AM	6:00 AM	6:00 AM	6:00 AM	6:00 AM	6:00 AM	6:00 AM
②		Leave	8:00 AM	8:00 AM	8:00 AM	8:00 AM	8:00 AM	8:00 AM	8:00 AM
③		Home	6:00 PM	6:00 PM	6:00 PM	6:00 PM	6:00 PM	6:00 PM	6:00 PM
④		Sleep	10:00 PM	10:00 PM	10:00 PM	10:00 PM	10:00 PM	10:00 PM	10:00 PM

HOW TO MODIFY THE HEATING SCHEDULE:

Step 1: Press  to start the process.
 Mon begins to flash. Press  or  to select the Day of the Week you would like to modify.



Step 2: Press  again to move to the next step and select the Time Period you would like to modify.
 Period 1 icon  begins to flash. If changing Period 1, Press  again to move to next step. Or Press  or  to change to the Time Period you would like to modify such as Period 2  or Period 3  or Period 4 .

PROGRAMMING THE HEATING SCHEDULE

HOW TO MODIFY THE HEATING SCHEDULE - Continued:

Step 3: Press  again, Hour begins to flash. Press  or  to set the Hour the period starts.

Step 4: Press  again, Minutes begin to flash. Press  or  to set the Minutes for period start time.

Step 5: Press  again to select the next period of the selected day to modify that period program according to the steps above.



After modifying the heat schedule as needed, Press  to save setting or wait for 15 seconds and the setting will be saved automatically.

COPY & PASTE A DAY'S SCHEDULE - Save Time Programming!

If you would like to copy the schedule for a specific day and add it to other days of the week, follow these steps and save time!

Step #1 After changing the schedule for a specific day (example Mon), Press  to save the day's schedule.

Step #2 Press the **COPY** icon to copy the selected day's schedule (example Mon). The remaining Days of the Week will appear on the screen.

Step #3 Press each day of the week that you want to paste Monday's schedule to. (For example: Tues, Wed, Thr, Fri). As you press each day, a line will appear under the days you have selected.

Step #4 Press  to confirm the pasted schedule.



HEATING SCHEDULE OVERRIDE / ADJUSTING THE TEMPERATURE - (Temporary)

To adjust the desired temperature up or down, touch  and  on the thermostat home screen.

Note: Adjusting the temperature will temporarily override the current set point until the next schedule period unless you want to use one of the schedule overrides on the following page.

GENERAL OPERATION

ECO PRO CONTROLLER OPERATING MODES

SYSTEM MODES:

ECO PRO Controller has 3 system modes (Schedule, Override, Permanent Hold) that indicate the state of the system. The current mode is displayed to the right of the Set To temperature on the home screen. The set duration of the current mode is displayed to the right of that, showing the time the system mode is active until. This makes it easy to identify when the next system change will occur.

- Schedule:** System is running based on the programmed heating schedule.
- Override:** System, is running based on a manually set override for a limited amount of time.
- Permanent Hold:** System is running on a manually set override that will be permanently held until manually turned off.



OPERATION MODES:

ECO PRO Controller has 4 operation modes (Heat, Timer, Hold, Fan Only). The current mode is displayed on the left, under the Date and Time on the home screen. The set duration of the current mode is displayed at the bottom right of the Set To temperature, showing the time it is active until.

To cycle through the available operation modes, touch **Mode**  on the thermostat home screen and select the appropriate mode and settings.

- Heat:** This is the default operation mode based on the heating schedule you have programmed.
- Timer:** This is a **temporary** system override based on the current system settings, that will expire after a length of time you set.
- Hold:** This is a **permanent** system override that holds the current system settings permanently, until manually canceled.
- Fan Only:** This is an operating mode to run the fan only, typically used in the summer for cooling.

CHANGING THE OPERATION MODES:

Timer Mode: Press  once to enter into Timer Mode.

The timer Hour begins to flash. Press  or  to adjust the Hour for when the timer expires.

Press  and Minutes begin to flash. Press  or  to adjust.

Press  to save. Pro Controller will run based on current settings for that set period of time.

To cancel, press  three times to return to Heat mode. Press  to save the mode.

Hold Mode: Press  two times to enter into Hold Mode.

Press  to save the mode.

Pro Controller will **permanently** hold the current temperature until manually canceled.

To cancel, press  two times to return to Heat mode. Press  to save the mode.



Timer Mode



Hold Mode

GENERAL OPERATION

CHANGING THE OPERATION MODES - Continued:

Fan Only Mode: Press  three times to enter into Fan Only Mode.
Press  to save the mode.

When fan mode is selected there is no heat output. Fan turns on when room temperature is higher than the set temperature. When room temperature drops to the set temperature, fan turns off.

Note: The system functions as a cooling thermostat.



Fan Only Mode

To cancel, press  one time to return to Heat mode. Press  to save the mode.

Heat Mode: Press  four times to return to Heat Mode. System functions based on Programmed Heat Schedule again.
Press  to save the mode.

SYSTEM OFF/STANDBY FUNCTION:

Press  button to enter or exit Standby Mode. System will enter "System Off" or "Freeze Protection Off", depending on what default was set during INITIAL SETUP



System Off

(Heat Stays OFF Regardless of Room Temp)







Freeze Protection Off

(Heat Turns On When Room Drops Below 40F)

MULTIPLE HEATERS PAIRED TO CONTROLLER - SYSTEM STATUS CHECK:

When multiple heaters are paired to a single ECO PRO Controller, if the heaters are installed in different rooms the status of each heater will be different based on the ambient temperature in each room. Follow the below steps to check the status of each heater:

Press & Hold  for 5 seconds to enter the check mode. The middle number represents different heaters, press  or  to check the status of each heater and the mode of it. Press  to exit.

GENERAL OPERATION

MAX TEMPERATURE LIMIT SETTING:

This setting allows the user to set a limit on the highest temperature setting allowed on the thermostat. It can be used in high traffic areas and can help prevent energy waste.

Press  button to enter OFF mode

Press and hold  and  button simultaneously for 5 seconds to enter **Max Temperature** setting mode

Press  or  to adjust the max temperature (40~95 °F)

Press  to confirm the setting or wait for 15 seconds and the setting will be saved automatically.

DISPLAY LOCK MODE:

Display Lock is designed for high traffic areas and deactivates the heater display buttons to prevent unwanted temperature adjustments. However settings can still be adjusted through the remote control.

Press and hold  and  button simultaneously for 5 seconds to enter **Display Lock Mode**. All buttons on the Heater Display and ECO PRO Controller will be disabled until unlocked.

To Unlock: Press and hold  and  button for 5 seconds to exit Display Lock Mode.

Note: While in Display Lock Mode, the heater operates at the last known settings.



Display Lock



LOW BATTERY INDICATOR

When running on battery power, the display shows  when the batteries are low on power. Replace batteries or plug into wall power.



Low Battery Indicator

FACTORY RESET UNIT

Press and hold  and  button simultaneously for 10 seconds. All lights on the display will flash to confirm reset was completed, and then the unit returns to its factory default settings & program.

DISPLAY WAKEUP (Wall Adaptor Connected)

The ECO PRO Controller has a proximity sensor, so as you approach the controller the display will turn on automatically (detection range is 5 feet). When there is no activity for 30 seconds, the display will turn off automatically.

If the display does not turn on when you approach the controller, you can also press the  icon on the display to wake it up.

DISPLAY WAKEUP (Battery Powered)

When powered with batteries only, the display will automatically turn off after 15 seconds to save battery life.

CREATE A HEATING ZONE - Connect Multiple Heaters

Control Temperatures and Save Energy with Zoned Heating Systems

A zoned heating system allows homeowners to control the temperature of each room or zone individually, thereby maximizing comfort and minimizing energy costs. A zoned system can be adjusted for numerous factors, including room usage, personal preferences, and environmental conditions. Zoned systems help homeowners use their heating systems more effectively by distributing heat where and when it is needed.

A single ECO PRO Controller can be paired to multiple heaters, creating a Heating Zone that is controlled by a single heating schedule. All heaters in this zone will be synchronized to the heating schedule of the ECO PRO Controller.

Creating a Heating Zone

Step 1: Pair Multiple Heaters To A Single ECO PRO Controller

Follow the **Pairing and Usage setup instructions on page 4** of this manual to pair each heater in the required heating zone to a single ECO PRO Controller. After pairing the first heater, repeat steps to pair each additional heater.

Step 2: Program The Desired Heating Schedule

Follow the **Program The Heating Schedule instructions on page 9** to create a heating schedule for the ECO PRO Controller.

Step 3: Operation

All heaters within this heating zone are now synchronized and will operate off the programmed heating schedule. Any changes made to the ECO PRO Controller will effect all heaters in this zone. The ambient room temperature will be detected at the location of the ECO PRO Controller, so proper placement of the ECO PRO Controller is important. Locate the ECO PRO Controller in the coldest spot in the heating zone to eliminate any cold areas within the zone.

DIAGRAM OF AN EXAMPLE HEATING ZONE

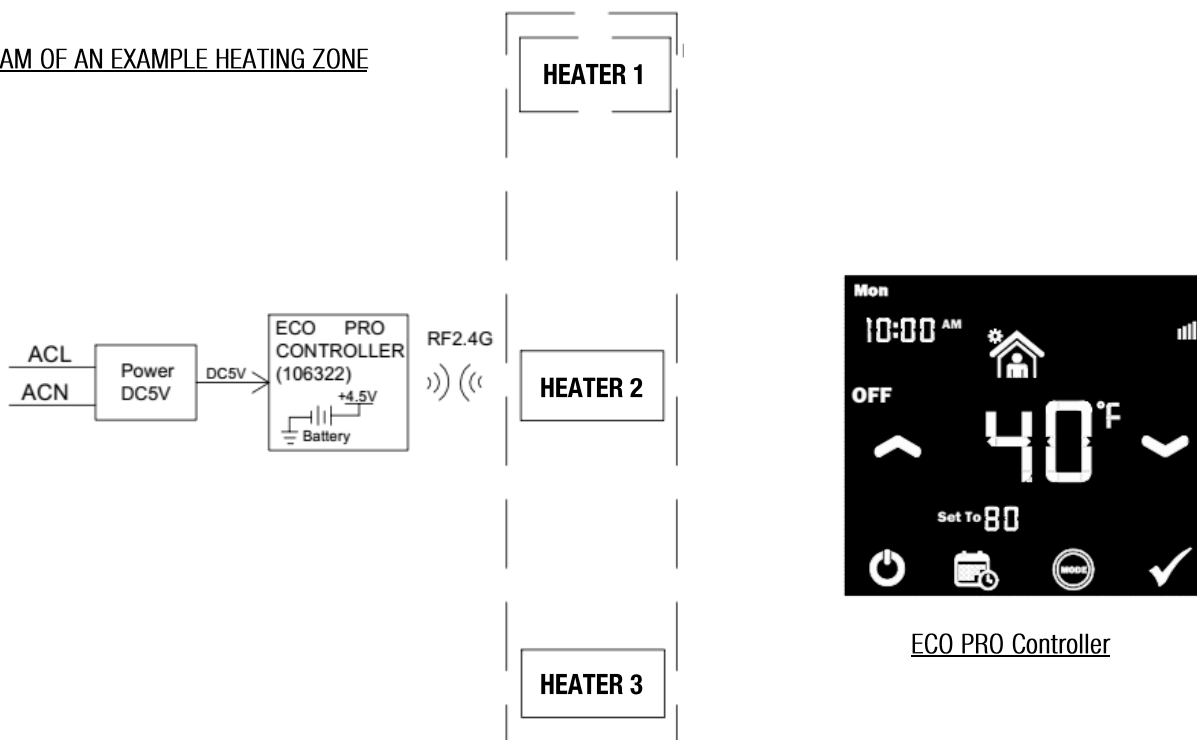

ECO PRO Controller

WIRED WINDOW/DOOR SENSOR (OPTIONAL)

LPW ECO PRO Heater features onboard terminals (Figure A) that allow a wired auxiliary window/door sensor for automatic triggering of a setback or off state when the contacts open.

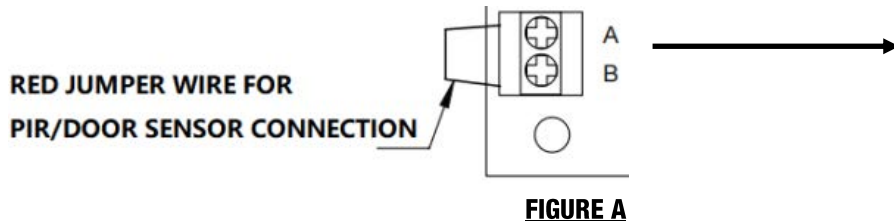

NOTE: DO NOT REMOVE RED JUMPER UNLESS WIRED WINDOW/DOOR SENSOR IS BEING USED.

CONNECTING A WIRED WINDOW/DOOR SENSOR TO THE SYSTEM

Step 1: Wire Window/Door Sensor To Heater

To utilize the Window/Door Sensor capabilities remove the red jumper wire between terminals A and B on the control terminal board. (See Figure A). Connect two wires from a dry contact (no voltage) of the Window/Door Sensor to terminals A and B.

Step 2: Dip Switch Selection: On back of the Control Display, **switch Dip Switch #3** to ON position to activate Window/Door Sensor capabilities.

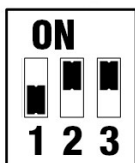

OPERATION

When paired with an optional Window/Door sensor, if the window or door is opened for longer than 12 seconds, the heater will automatically set-back to the setback temperature preset under Setting #6 in the Initial setup (See page 7), and the display on the ECO PRO Controller will display and the heater displays "FP" for Freeze Protection Mode.



Setback Options: 40°F (default), 45°F, 50°F, or 55°F Set on Setting #6 in the Initial setup (See page 7)

When Window/Door Sensor is CLOSED, after 12 seconds the heater resumes operating at previous temperature settings.



ECO PRO Controller - Window/Door Setback

Heater Display - Window/Door Setback



WIRED PIR OCCUPANCY SENSOR (OPTIONAL)

LPW ECO PRO Heater features onboard terminals (Figure A) that allow a wired auxiliary or PIR Occupancy Sensor for automatic triggering of a setback or off state when the contacts open.

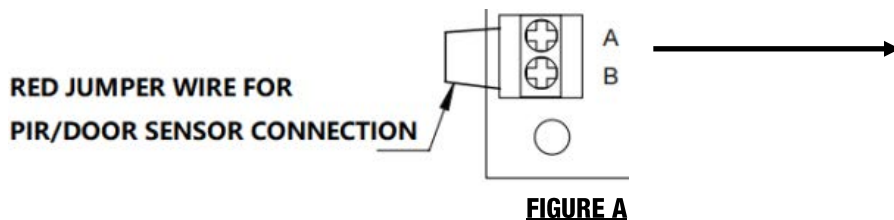

NOTE: DO NOT REMOVE RED JUMPER UNLESS WIRED PIR OCCUPANCY SENSOR IS BEING USED.

CONNECTING A WIRED PIR OCCUPANCY SENSOR TO THE SYSTEM

Step 1: Wire PIR Occupancy Sensor To Heater

To utilize the PIR Occupancy Sensor capabilities remove the red jumper wire between terminals A and B on the control terminal board. (See Figure A). Connect two wires from a dry contact (no voltage) of the PIR Occupancy Sensor to terminals A and B.

Step 2: Dip Switch Selection: On back of the Control Display, switch Dip Switch #3 to OFF position to activate PIR sensor capabilities.



OPERATION

When paired with an optional PIR Occupancy sensor, if there is no activity in the room for the set time period, the heater will automatically setback to the setback temperature preset under Setting #7 in the Initial setup (See page 7). The display on the ECO PRO controller will display  and the heater displays “FP” for Freeze Protection Mode.

Setback Options: 45°F, 55°F, 60°F (default), or 65°F Set on Setting #7 in the Initial setup (See page 7)

When someone enters the room and the PIR sensor senses activity, the heater resumes operating at previous temperature settings.



ECO PRO Controller - PIR Setback

Heater Display –PIR Setback



BUILDING MANAGEMENT (BMS) LOCKOUT CIRCUIT

LPW ECO PRO Heater features onboard terminals (Figure A) that allow the heater to be wired to a Building Management System (BMS) to prevent the heaters from running when the building is in cooling mode.

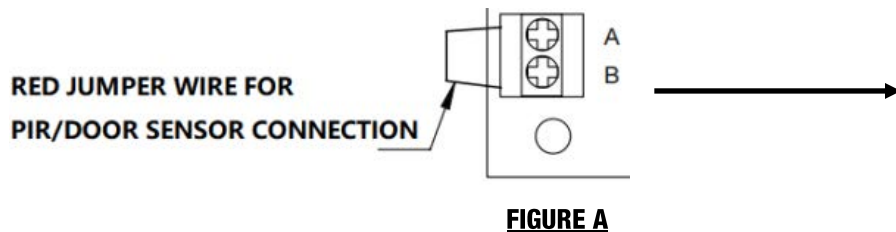

NOTE: DO NOT REMOVE RED JUMPER UNLESS BMS SYSTEM CONTROL IS BEING USED.

CONNECTING BMS SYSTEM LOCKOUT FEATURE

Step 1: Wire BMS System To Heater

To utilize the BMS capabilities remove the red jumper wire between terminals A and B on the control terminal board. (See Figure A). Connect two wires from a dry contact (no voltage) in the BMS system to terminals A and B.

Step 2: Dip Switch Selection: On back of the Heater Display, switch Dip Switch #3 to ON position to activate BMS Lockout capabilities.



Step 3: Heater Display Setup: Press and hold both  and  buttons for 5 seconds to set BMS Lockout to "OF" for OFF mode.

OPERATION

When connected to a BMS System and the BMS lockout circuit is activated, the heater functions will not work. The display on the heater displays "OF" for OFF Mode and the display on the ECO PRO Controller will display 

When BMS releases control, heater functions are available and heater resumes operating at previously programmed settings. Refer to your BMS Systems Operations Manual for details.



ECO PRO Controller - Heater Locked Out

Heater Display – Heater Locked Out



RF AUXILLARY WINDOW/DOOR SENSOR (OPTIONAL)

LPW ECO PRO Heater also allows for connection of an RF (radio frequency) auxiliary Window/Door sensor for automatic triggering of a temperature setback when the contacts open. It monitors whether a window/door has been left open and set back the temperature automatically to a predefined temperature.

PAIRING AND USAGE GUIDE

Since it is possible that more than one heater/ECO PRO Controller would be used in a home, you must first pair the RF auxiliary sensor to a specific heater. Each RF auxiliary sensor has a unique ID number, which will be used in the pairing process. When installing the RF auxiliary sensor the first time, users need to pair the RF auxiliary sensor with the heater, so the heater can learn and save the remote sensor's ID.

Step 1: On the Heater's Display Press  and  buttons at the same time for 5 seconds. The LED display will flash "id". Release buttons.

Step 2: Put the RF auxiliary Window/Door sensor within 3 feet of the heater and then press and hold the pair button on the sensor for 5 seconds to enter pairing mode.

Step 3: The heater's display indicator lights will illuminate (LED tubes show 88) for 1 second and then turn off. The indicator light on the RF Window/Door sensor will flash three times.

This means the RF auxiliary sensor and the heater have paired with each other successfully.

OPERATION

When paired with an optional Window/Door sensor, if the window or door is opened for longer than 12 seconds, the heater will automatically setback to the setback temperature preset under Setting #6 in the Initial setup (See page 7) and the display on the ECO PRO Controller will display  and the heater displays "FP" for Freeze Protection Mode.

Setback Options: 40°F (default), 45°F, 50°F, or 55°F Set on Setting #6 in the Initial setup (See page 7)

When Window/Door Sensor is CLOSED, after 12 seconds the heater resumes operating at previous temperature settings.

BATTERY INSTALLATION

Remove back cover, install battery (CR2032/3V)

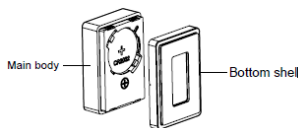

LOW BATTERY

In a low battery condition a blue indicator light will flash 5 times. Once battery dies, heater will automatically enter Freeze Protection Mode. The Heater display will show "FP" until the batteries are replaced.



ECO PRO Controller - Window/Door Setback



Heater Display
Window/Door Setback

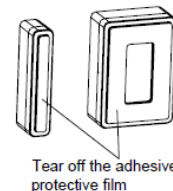

Tear off the adhesive protective film

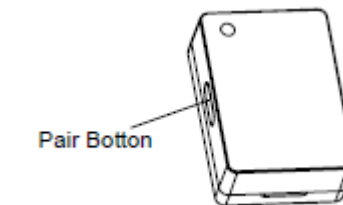
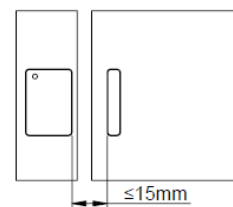

LPW-ECO Control Panel

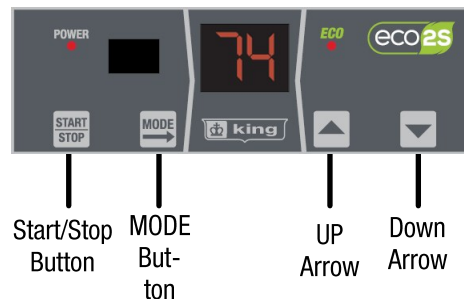

INSTALLATION

Remove adhesive protective film on the bottom shell and fix it on the door or window, as shown.

RF AUXILLARY PIR SENSOR (OPTIONAL)

LPW ECO PRO Heater also allows for the connection of an RF (radio frequency) auxiliary PIR Occupancy sensor for automatic triggering of a temperature setback when the contacts open. It can monitor whether there are people in the detectable range and when the sensor detects no movement, set back to a predefined temperature.

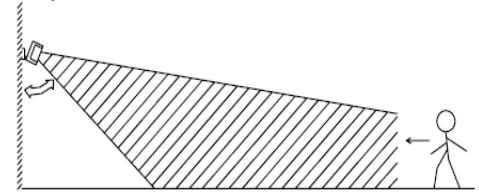

PAIRING AND USAGE GUIDE

Since it is possible that more than one heater/ECO PRO Controller would be used in a home, you must first pair the RF auxiliary sensor to a specific heater. Each RF auxiliary sensor has a unique ID number, which will be used in the pairing process. When installing the RF auxiliary sensor the first time, users need to pair the RF auxiliary sensor with the heater, so the heater can learn and save the remote sensor's ID.

Step 1: On the Heater's Display Press  and  buttons at the same time for 5 seconds. The LED display will flash "id". Release buttons.

Step 2: Put the RF auxiliary PIR sensor within 3 feet of the heater and then press and hold the pair button on the sensor to enter pairing mode.

Step 3: The heater's display indicator lights will illuminate (LED tubes show 88) for 1 second and then turn off. The indicator light on the RF PIR sensor will flash three times.

This means the RF auxiliary sensor and the heater have paired with each other successfully.

LPW-ECO Control Panel

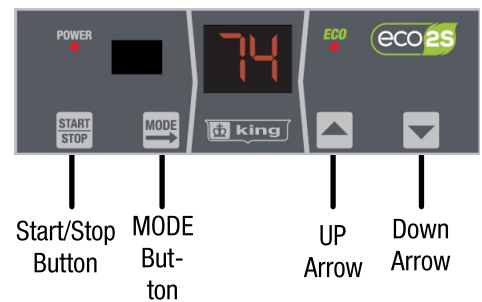

SET DELAY OFF TIME

Step 1: Press the TIME button to set the delay off time as per the below table:

Press Button Times	Green Indicator Flash Times	Delay Off Time
Once	Once	10 Minutes
Twice	Twice	30 Minutes
Three Times	Three Times	60 Minutes

SET SENSOR DETECTION SENSITIVITY

Step 1: Press the SEN button to set the detection sensitivity as per the below table. When set to the high sensitivity, the max detection range is 16 feet.

Press Button Times	Green Indicator Flash Times	Sensitivity
Once	Once	LOW
Twice	Twice	Middle
Three Times	Three Times	High

BATTERY INSTALLATION

Remove back cover, install battery (CR123A/3V) or plug-in adapter (Purchased Separately).

LOW BATTERY

In a low battery condition a blue indicator light will flash 5 times. Once battery dies, heater will automatically enter Freeze Protection Mode. The Heater display will show "FP" until the batteries are replaced.

OPERATION

If there is no activity in the room for the set time period, the heater will automatically setback to the setback temperature preset under Step #7 in the Initial setup (See page 7). The display on the ECO Pro Controller will display and the heater displays "FP" for Freeze Protection Mode.

Setback Options: 45°F, 55°F, 60°F (default), or 65°F Set on Setting #7 in the Initial setup (See page 7)

When someone enters the room and the PIR sensor senses activity, the heater resumes operating at previous temperature settings.

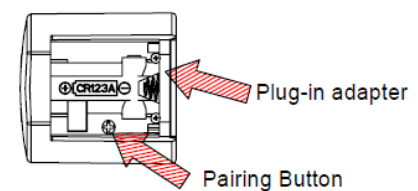
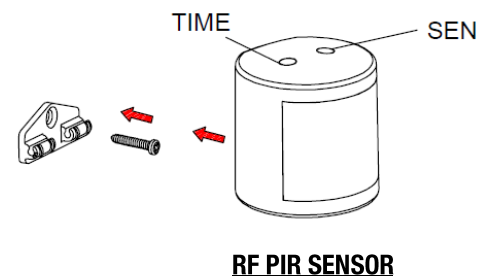

RF SENSOR CONFIGURATION OPTIONS (OPTIONAL)

Each ECO PRO heater can be paired to a maximum of 1 x PIR sensor and 4 Window/Door Sensors. When ECO PRO heater(s) are paired to auxiliary RF sensor(s), there are 2 configuration options.

Multiple heaters can be configured to a single ECO PRO controller. Separate auxiliary sensors can be assigned to each heater, or one set of sensors can be assigned to control multiple heaters as a heating zone. See below for details of each setup

OPTION A - Multiple Heaters Controlled By Separate Sensor Sets

The three heaters connected with a single ECO PRO Controller are in three different rooms. On this condition, the three heaters will work separately and the control of the three heaters via auxiliary sensors will not be synchronized as per the diagram. Each sensor set acts to control a single heater.

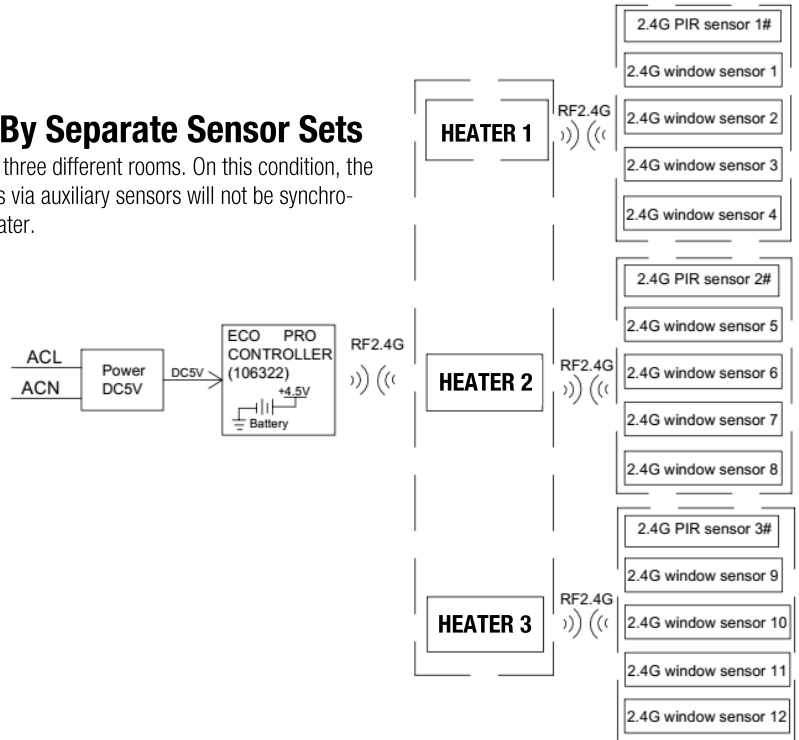

OPTION B - Multiple Heaters Controlled By A Single Sensor Set

When the three heaters are in the same room, only one heater needs to be connected with the RF PIR Motion sensors and door sensors, and the control of this heater will be synchronized to the other two heaters as per below diagram.

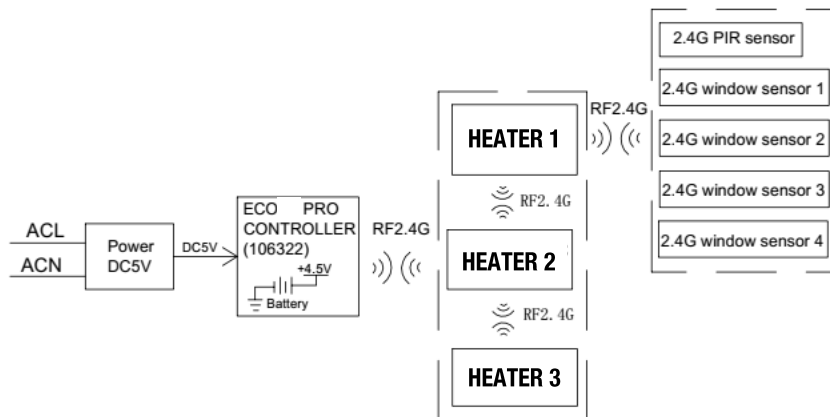

ECO HEATER DISPLAY OPERATION

Operation of Display Control Panel on Heater



1. Push the  button, the heater will come on and heat to the default setting of 72°F.
2. Once the room temperature reaches the set point, the heating elements will turn off followed by a 3 minute fan delay period to exhaust excess heat from the case. Afterwards the unit will turn off.
3. In normal operation the display will show the current room temperature.

Automatic 2-stage HIGH/LOW Operation

ECO PRO Heaters offer energy efficient 2-stage heating, automatically using the lowest wattage required to heat the room.

- During operation, when the set temperature is within 3 degrees of the room temperature the heater automatically switches to ECO mode, operating at LOW wattage.

Room Temperature Selection

- During operation, push  or  arrow buttons to set the temperature from 40°F-95°F, Hold down the UP or DOWN arrow to speed up the selection process. The LCD will go back to display room temperature after 5 seconds.

Timer Mode Selection

- During operation, press the  button 1 time, the display window will show the timer mode setup. Push  or  to set Timer from 0 hour - 9 hours. (0H-9H).

In timer mode the heater operates based on the thermostat's set point. Once the timer period expires, the heater will then be permanently off.

Fan Only Mode Selection

- During operation, press the  button 2 times, the display window will show [H] (Heat Mode) or [F] (Fan Only Mode).

Push  or  to switch between Fan Only and Heat modes.

Display Lock Feature

Display Lock is designed for high traffic areas and deactivates the heater display buttons to prevent unwanted temperature adjustments. However, settings can still be adjusted through the remote control.

- During operation, press and hold the  button for 5 seconds to set the display lock. [L] will appear on the display temporarily if a user attempts to make a temperature adjustment.

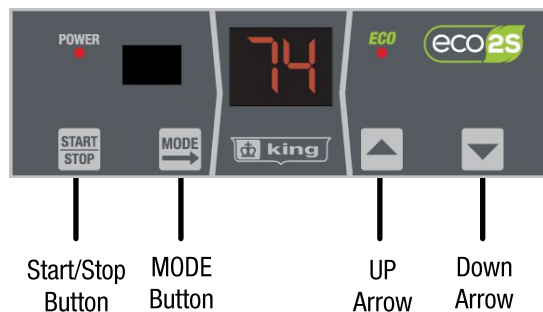

Control Panel



ECO HEATER DISPLAY OPERATION

Setting “Environment” Mode

Two Environment Options: Standard [SF] and Bedroom [BE].
 Bedroom Mode turns off the display after 30 seconds for people using this heater in a bedroom environment. Once any button is pressed the display turns back on.

- During operation, press and HOLD the  and  buttons for 3 seconds. Then press UP or DOWN to select “Bedroom Mode” [BE] or “Standard Mode” [SF]



Factory Reset

- During operation, press and HOLD the  button for 5 seconds to reset to the factory settings. [FA] will flash on the display once done.

Setting Differential Value

The differential or gap affects how often the heater cycles. The lower the differential setting, the more the heater will cycle. If heater cycles too often, raise the differential setting to a higher degree.

- Press and HOLD the  and  buttons for 5 seconds. The display will show the previously set differential.

Press  or  to adjust the differential value between -0 to -5F.

Sensor Error Code

- During operation, if the display shows [E1], that indicates an issue with the backup sensor inside the heater and the sensor needs to be replaced. Contact customer support for assistance.

Control Panel

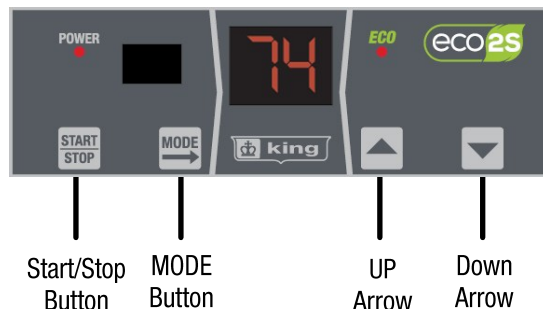

SMART LIMIT PROTECTION



This heater is equipped with a thermal overload Smart Limit Protection which disconnects elements and motor in the event normal operating temperatures are exceeded. If thermal overload trips due to abnormal operating temperatures, thermal overload shall remain open until manually reset by turning the heater OFF for fifteen minutes. Inspect for any objects on or adjacent to the heater that may cause high temperatures. After inspecting the heater, keep the power to the heater off for 10 minutes to reset the SLP thermal protector. If the SLP thermal protector shuts the heater off again, immediately turn the heater OFF at the circuit breaker and inspect the heater for possible fan motor failure or dirt and lint on the heating element. Repeat the starting procedure. **DO NOT TAMPER OR REMOVE THIS THIS DEVICE.**

GUIDELINES & MAINTENANCE

General information and guidelines:

This heater must be properly installed before it is used. DO NOT tamper with or change the operation of this heater.

1. This heater must be properly installed in accordance with the National Electrical Codes (NEC) & local electrical codes before it is used.
2. After the electric heater has been completely installed, all thermostats should be turned to OFF. Turn ON breakers, wait 3 to 5 minutes. Check to see that all heaters are operating. Should any not be operating, disconnect power and check wiring.
3. Allow entire system to operate steadily for 1/2 hour. This should remove oily residue from manufacturing. (Some smoking may occur).

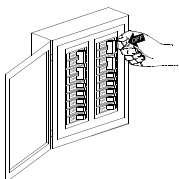

Maintenance & Cleaning: Basic maintenance is listed below and should be performed annually. When necessary, any required servicing should be performed by qualified service personnel. Your heater will give you years of service and comfort with only minimum care. To assure efficient operation follow the simple instructions below.

WARNING: Turn the electrical power OFF at the electrical panel board (circuit breaker or fuse box) and lock or tag this panel board door to prevent someone from turning on power while you are working on this heater. Failure to do so could result in serious electrical shock, burns, or possible death.

1. Before removing grill, turn the electrical power OFF and allow elements to cool. Circuit breakers are often not marked correctly and turning the wrong breaker off could mean electricity is flowing to the heater, even if the heater does not appear to be working. If you are uncomfortable working with electrical appliances, unable to follow these guidelines, or do not have the necessary equipment, consult a qualified electrician. Once you verify the power is off completely and element is cool, proceed to the next step.
2. Remove screws and take off grill. Wash grill with hot soapy water and dry immediately
3. Using a hair dryer or vacuum on blow cycle, blow debris back through the element. Do not touch element. Vacuum or use a soft brush and remove loose debris without touching the elements. The fan motor does not require lubrication.
4. Re-attach grill and secure with screws.
5. Turn thermostat to desired setting.

WARNING: All other servicing should be performed by authorized service personnel.

TROUBLESHOOTING

Table 3

SYMPTOM	PROBLEM	SOLUTION
Breaker Trips	<ol style="list-style-type: none"> 1. Short Circuit 2. Overloaded Circuit 3. Improper Voltage 	<ol style="list-style-type: none"> 1. Find source of short. Trace heater circuit and verify the heater is wired properly. 2. Reduce wattage in circuit. Refer to circuit sizing table for maximum wattage. 3. Verify the heater voltage matches the supply voltage.
Heater not working	<ol style="list-style-type: none"> 1. No Power 2. Loose Connections 3. Defective Limit 	<ol style="list-style-type: none"> 1. Turn Breaker ON, turn thermostat ON, check that the breaker is positioned properly on panel bus-bar. A 2-Pole breaker must be connected to both bus-bars (A & B phase) to produce 240V power. 2. Tighten wire connections. 3. By-pass the limit to test. If heater works, replace the limit
Heater Smokes	<ol style="list-style-type: none"> 1. Oil on element 2. Needs Cleaning 	<ol style="list-style-type: none"> 1. It is normal for the element to burn off some light finishing oil used in the manufacturing process when first energized. Open windows and allow room to vent until it stops, usually within a few minutes. 2. Remove any dust or dirt accumulations.
Room Temperature does not match thermostat setting.	<ol style="list-style-type: none"> 1. Thermostat affected by another heat source. 	<ol style="list-style-type: none"> 1. Sunlight or other heat sources can affect the thermostat. Move the thermostat to another location or remove the heat source.

WARRANTY INFORMATION

King Electrical Manufacturing Company will repair or replace, without charge to the original owner, any LPW Series heater found to be defective or malfunctioning within 5 years of installation. This warranty requires the owner or his agent to install the equipment in accordance with the National Electrical Code, any other applicable heating or electrical codes, and the manufacturer's installation instructions. It further requires that reasonable and necessary maintenance be performed on the unit. Failure to properly maintain the unit will result in the warranty being voided. The company is not liable for abuse or misuse of product as may be finally determined by the company. The customer shall be responsible for all costs incurred in the removal or reinstallation of products, including labor costs and shipping costs incurred to return products to King Manufacturing. King Manufacturing will repair or replace, at our option, at no charge to the customer with return freight paid by King. King Manufacturing shall not be liable for consequential damages arising with respect to the product, whether based upon negligence, tort, strict liability or contract. No other written or oral warranty applies, nor any warranties by representatives dealers, employees of King, or any other person. All returns require a King Return Merchandise Authorization (RMA); Unauthorized returns will be refused. Do not return malfunctioning/defective products to store.

DO NOT RETURN PRODUCT
Are you experiencing difficulties?
We're Here to Help!
Call Us Toll Free at:
1-800-603-5464
(Select Option 2 from the Menu)
7:00 am -3:30 pm PST Mon-Fri
Or email us at tech@king-electric.com
Please have the following information available:
✓ Supply Voltage ✓ Heater Model Number
✓ Remote or Inbuilt Thermostat? ✓ Date of Installation



Smart Heating Solutions