

Line Voltage Thermostat K101, K102 & K101-C

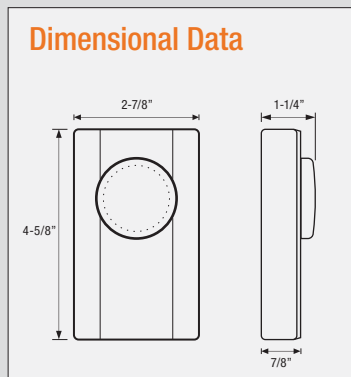

- Clean, beveled style suits any decor
- Sits flush against wall
- Includes °C and °F control dials
- Bi-metal mechanical sensing element
- Operates 41° - 90° F (3°- 32°C)
- Mounts directly to a 2x4 inch vertical electrical outlet box
- Large knob allows easy adjustment to all temperatures
- Single or Double Pole (positive off) available
- No ground wire design
- 1-year limited warranty



The K101 & K102 Series Thermostats

The K101 & K102 Series thermostats have a larger, more sensitive, mechanical bi-metal sensor that improves temperature accuracy to $\pm 3^\circ$ F. This feature achieves a better comfort level with a reduced temperature swing as compared to economy models. Modern appearance with large knob for easy adjustments. No ground wire required, making installation fast and easy.

The K101-C Cooling Thermostat

The K101-C cooling thermostat has a larger, more sensitive, bi-metal sensor that improves temperature accuracy to $\pm 3^\circ$ F. This feature achieves a better comfort level with a reduced temperature swing as compared to other mechanical thermostat models. Modern appearance with large knob for easy adjustments. No ground wire required, making installation fast and easy. For cooling only.

Ordering Information

MODEL	UPC	DESCRIPTION
K101	20576	Single Pole - WHITE
K101A	20525	Single Pole - ALMOND
K102	20623	Double Pole (Positive Off) - WHITE
K102-R	20627	Double Pole (Positive Off) - WHITE, RETAIL
K102A	20624	Double Pole (Positive Off) - ALMOND
K101-C	20631	Single Pole - WHITE, Cooling Only

Replacement Accessories

MODEL	UPC	DESCRIPTION
K101 TEMP PLATE C	22020	K101 Replacement Celsius Dial Face, White 5°-35°C
K101A TEMP PLATE C	22021	K101A Replacement Celsius Dial Face, Almond 5°-35°C
K101 TEMP PLATE F	22022	K101 Replacement Fahrenheit Dial Face, White 41°-90°F
K101A TEMP PLATE F	22023	K101A Replacement Fahrenheit Dial Face, Almond 41°-90°F
K102 TEMP PLATE C	22024	K102 Replacement Celsius Dial Face, White 10°-35°C
K102A TEMP PLATE C	22025	K102A Replacement Celsius Dial Face, Almond 10°-35°C
K102 TEMP PLATE F	22026	K102 Replacement Fahrenheit Dial Face, White 50°-90°F
K102A TEMP PLATE F	22027	K102A Replacement Fahrenheit Dial Face, Almond 50°-90°F

Specifications

Temperature Range: 41° F-90° F (5° C- 32° C) **Accuracy:** $\pm 3^\circ$ F (1.6°C) **Max Power:** 2640W@ 120VAC (25A)
Max Power: 4576W@208VAC (25A) **Max Power:** 5280W@ 240VAC (25A) **Max Power:** 6094W@ 277VAC (25A)
Sensing Element: Bi-metal mechanical