

**TPI-160-P-C-Y**

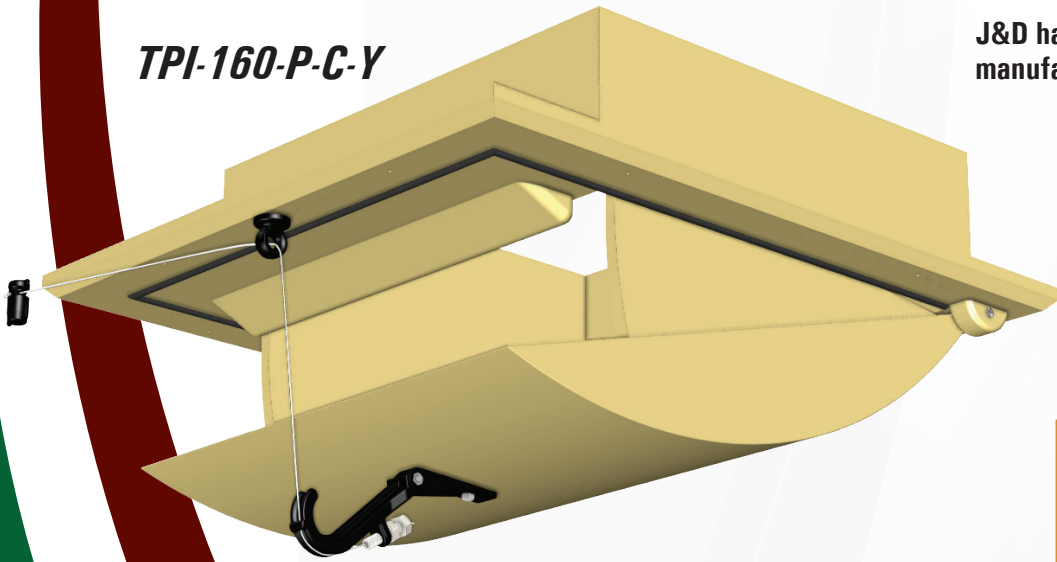

J&D has partnered with one of the best inlet manufacturers in the world, TPI Polytechnics.



**TPI-Aeron-Y**

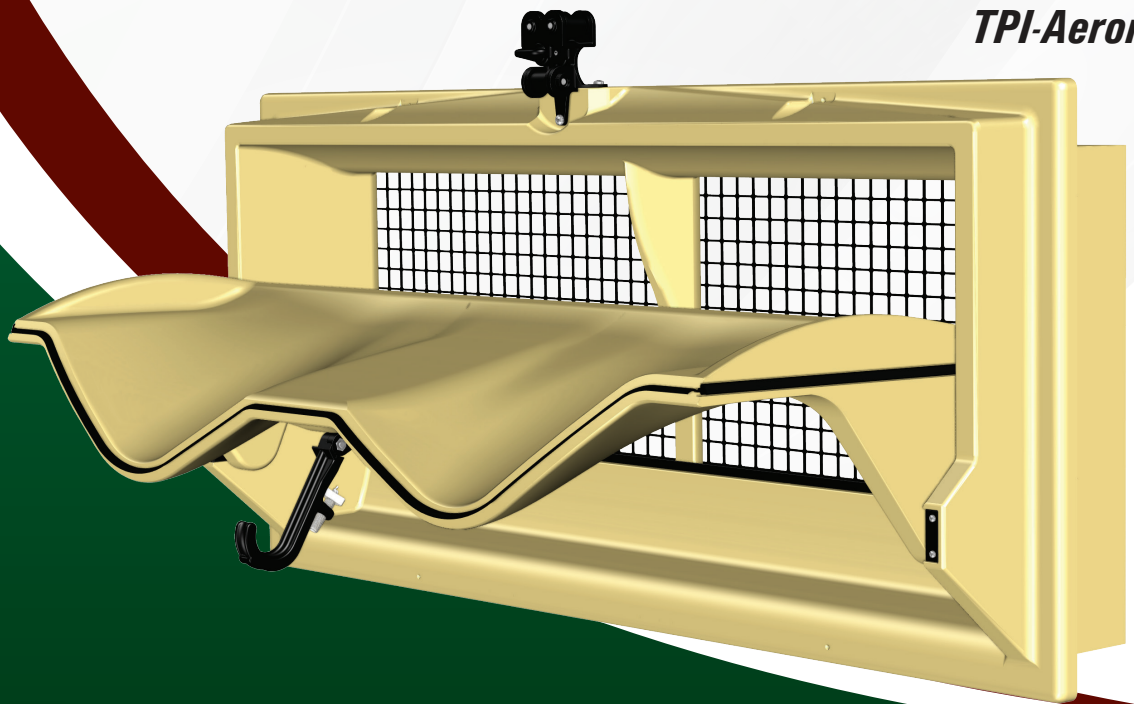

**J&D**  
**Manufacturing**

Inlets

**TPI INLETS**  
**HIGH QUALITY INLETS FOR EVERY NEED**

# Inlet Overview



## Pulley Unit with Integrated Latch

- Pulley Unit
  - Can guide cord in either direction
  - Top pulleys can act as a support to the main cable
  - Made out of strong and durable ABS plastic
- Latch
  - Locks inlet when needed

## Mesh

- Corrosion-resistant galvanized wire
- 0.4" square openings

## Louvers

- Each model specifically designed to aim and project air differently to fit different ventilation needs
- Made from insulating polyurethane foam
- Smooth to minimize air resistance and for easy cleaning

## Rubber/O-Lon Gaskets

- Minimize air infiltration when inlet is closed

## Specially Designed Control Arm

- Protects the inlet doors from cord wear by extending the cord beyond the edge of the inlet door
- Moves the pressure point from the edge of the inlet door to a more centralized location on the inlet door for a more even distribution of force, creating an even engagement with the gasket when closed
- Includes tension adjusting nut to allow for minor adjustments

## Curb

- Deflects air back down towards the curve of the door for better air control

## Polyurethane Foam Frame

- Very lightweight
  - Easy installation
  - Reduced transportation cost
- Unique formula provides smooth and strong outer skin
- Insulating
  - Minimizes formation of condensation on the inlet
  - Its low temperature transference minimizes the effects of outdoor temperatures when closed
- Durable, does not rust or rot

## Gasket

- Minimizes air leaks

## Door/s

- Cupped shaped with side shields to direct air out and up. Even when inlet doors are open wide, air mixes along the ceiling before sinking down to livestock level

Minimum ventilation is especially tricky in cold climates. The challenge lies in bringing small volumes of air up to speed to prevent the air dropping directly onto the animals. With a minimum as low as 80m<sup>3</sup>/h at 20Pa, the Aeron still guides air upwards to the center of the house.

Aeron is the ultimate air inlet for poultry houses with excellent control in both minimum and maximum ventilation due to its perfect aerodynamics of its unique louver shape.

- Curved Louver provides control over the air speed, direction, and volume in every ventilation stage
- Minimizes formation of condensation on the inlet
- Its low temperature transference minimizes the effects of outdoor temps when closed

All TPI Inlets come in Yellow or Black. To order Black color, change "-Y" to "-B" at the end of the part number.

Part#	CFM @			m <sup>3</sup> /h			Force	
	.05" SP	.10" SP	.15" SP	10 Pa	20 Pa	40 Pa	Nw	Run
TPI-AERON-Y	2,040	2,890	3,552	3,100	4,400	6,200	44.0	21.7"

**Rough Opening**  
40.55" W x 16.93" H

*A radical new approach to designing wall inlets, the Aeron offers a revolutionary new shape and design to provide the optimal combination of capacity and airflow.*

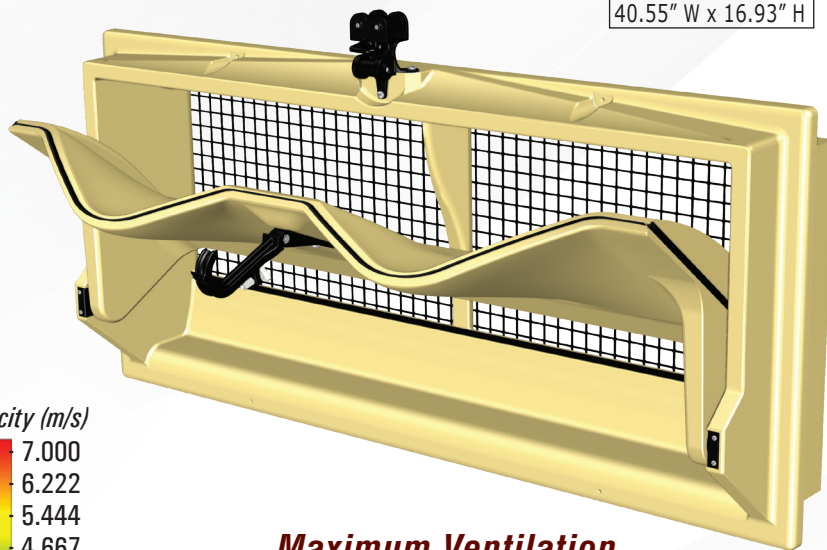

**Minimum Ventilation**

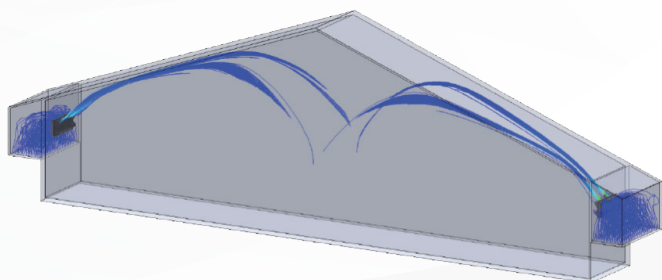

Velocity (m/s)

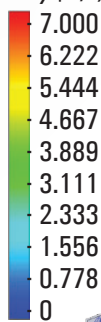

**Maximum Ventilation**

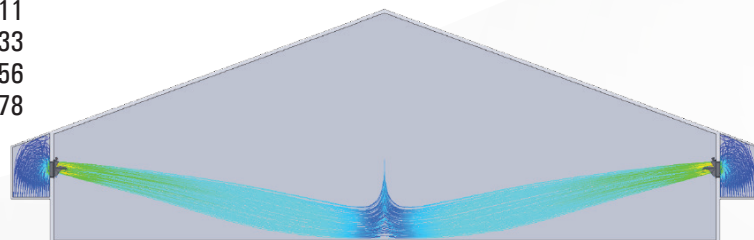

# Uni-Directional Wall Inlets



The inner valve and house of these inlets are equipped with seals all around to prevent air leakage. Curved inner corners in the house make for a better airflow.

- Materials and air seals help to make these inlets perfectly suitable for use in extremely low temperatures
- Curved louvers direct air down on animals during maximum ventilation
- Sizes perfect for retrofitting your house or building new

**TPI-3000-VFBR-C-Y**

TPI-3000-VFBR-C-Y Air Inlet

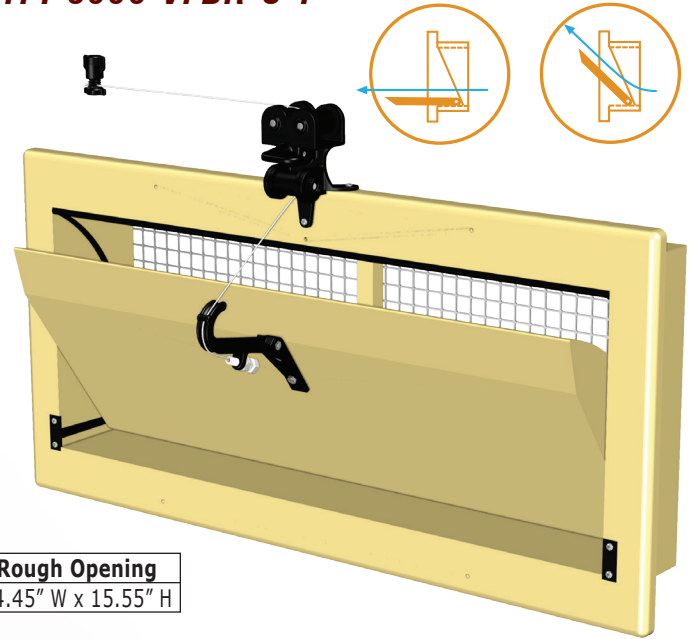

**Rough Opening**  
34.45" W x 15.55" H

**TPI-3000-VFBG-C-Y**

**Rough Opening**  
34.45" W x 15.55" H

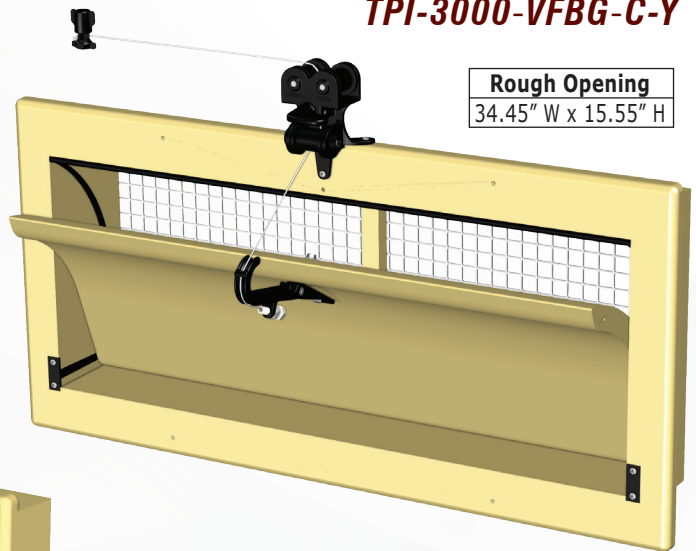

TPI-3000-VFBG-C-Y Air Inlet



Part#	CFM @			m <sup>3</sup> /h			Force Nw	Run
	.05" SP	10" SP	15" SP	10 Pa	20 Pa	40 Pa		
TPI-3000-VFBG-C-Y	1,908	2,693	3,297	2,900	4,100	5,800	19.6	20.1"
TPI-3000-VFBR-C-Y	1,908	2,693	3,297	2,900	4,100	5,800	19.6	16.1"
TPI-VENTUM-Y	2,290	3,218	3,950	3,480	3,480	6,950	29.4	18.5"

All TPI Inlets come in Yellow or Black. To order Black color, change "Y" to "B" at the end of the part number.

**TPI-Ventum-Y**

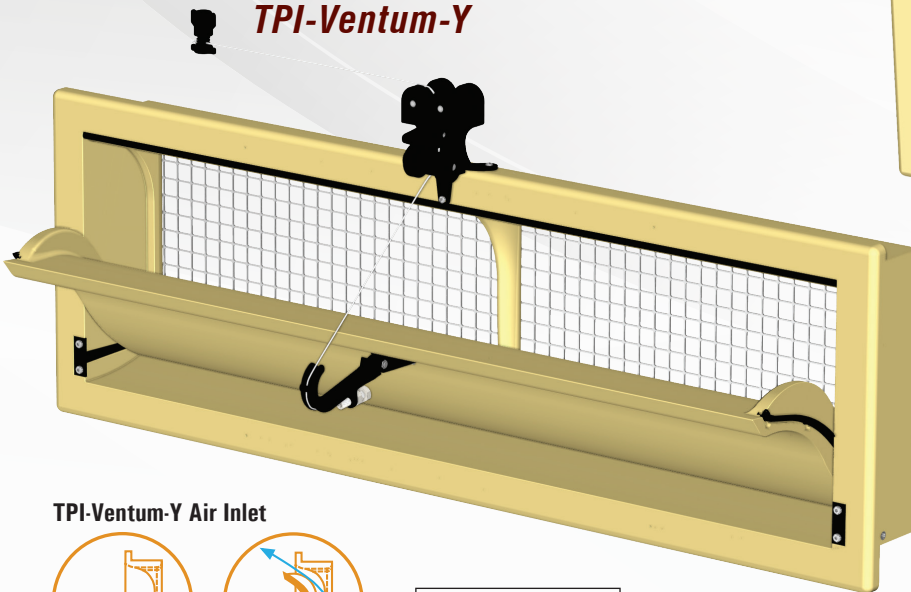

TPI-Ventum-Y Air Inlet

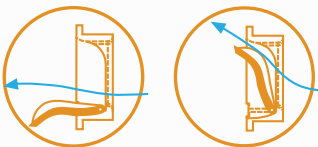

**Rough Opening**  
44.88" W x 13.78" H

# TPI-2000-PBR-C-Y Wall Inlet

As an exception, this inlet is not made out of polyurethane, but out of UV-stabilized ABS. This air inlet is specially developed for areas where insulation is less relevant. The inner valve of the inlet is still insulated with an EPS panel. With a straight louver, the air is not guided downwards onto the animals during maximum ventilation.

- The TPI-2000-PBR-C-Y inlet is spring closed and therefore the pulley is mounted upside down on the bottom flange
- The straight louver guides air in a straight upwards or horizontal direction, never downwards on the animals where it's not wanted
- Uni-directional air inlet, so the air only travels above the louver for better airflow control

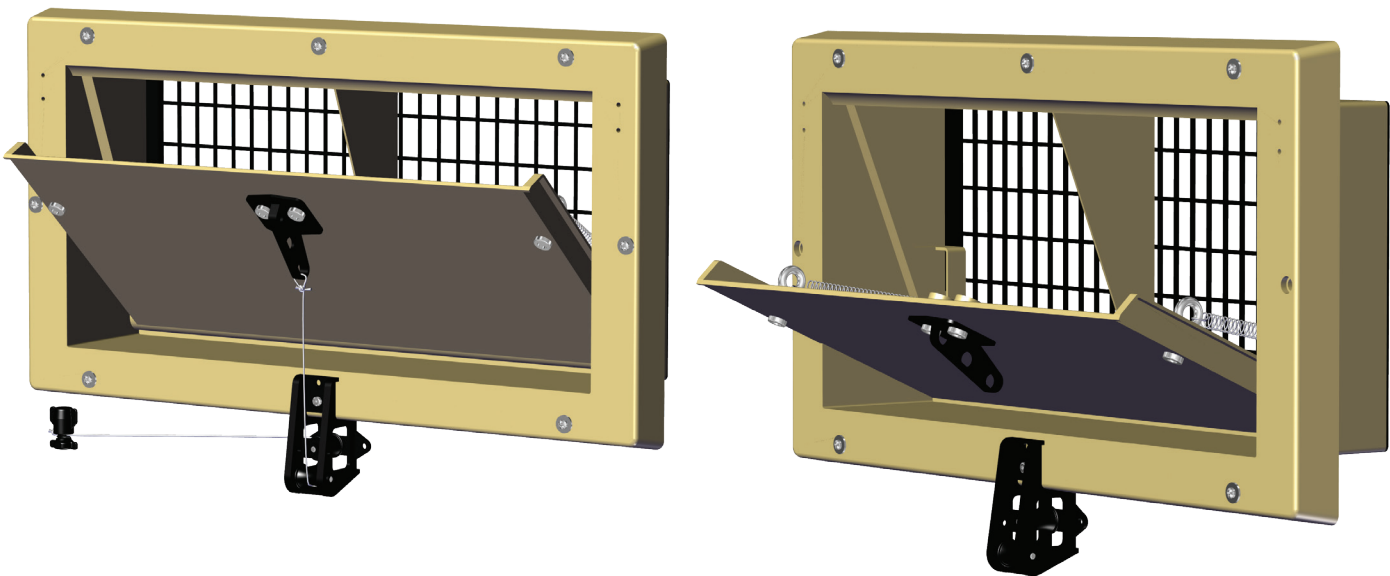

Part#	CFM @			m <sup>3</sup> /h			Force	
	.05" SP	.10" SP	.15" SP	10 Pa	20 Pa	40 Pa	Nw	Run
TPI-2000-PBR-C-Y	1,184	1,642	2,046	1,800	2,500	3,600	88.3	7.9"

Rough Opening
26.77" W x 12.99" H

# Bi-Directional Wall Inlets



Inlets are made from insulating polyurethane foam and each model specifically designed to aim and project air differently to fit different ventilation needs.

- When the louver is fully open for maximum ventilation, the air below the louver is guided downwards towards the animals, providing additional cooling and fresh air at animal level

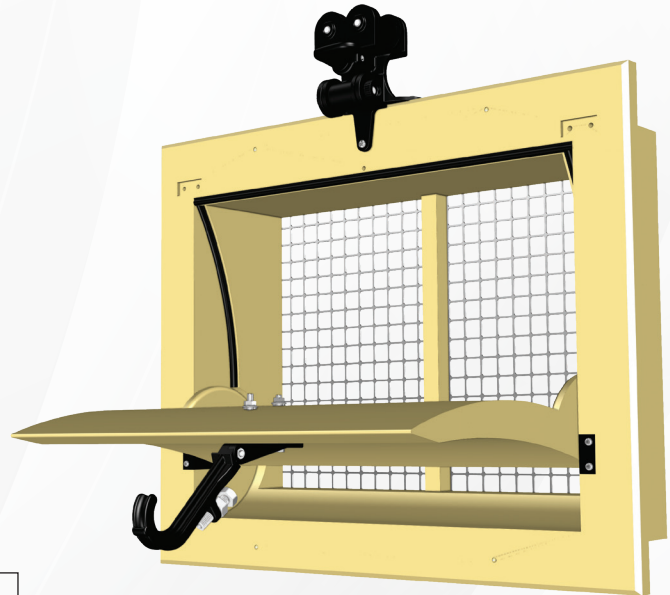

**TPI-1800-VFG-C-Y**

Part#	CFM @			m <sup>3</sup> /h			Force	
	.05" SP	.10" SP	.15" SP	10 Pa	20 Pa	40 Pa	Nw	Run
TPI-1800-VFG-C-Y	1,184	1,642	2,046	1,800	2,700	3,600	14.7	18.5"
TPI-3000-VFG-C-Y	1,908	2,693	3,297	2,900	4,100	5,800	19.6	16.9"
TPI-4000-VFG-C-Y	2,566	3,612	4,433	3,900	5,500	7,800	19.6	24.6"

All TPI Inlets come in Yellow or Black. To order Black color, change "-Y" to "-B" at the end of the part number.

**TPI-1800-VFG-C-Y Air Inlet**



**Rough Opening**  
21.85" W x 16.73" H

**TPI-3000-VFG-C-Y**

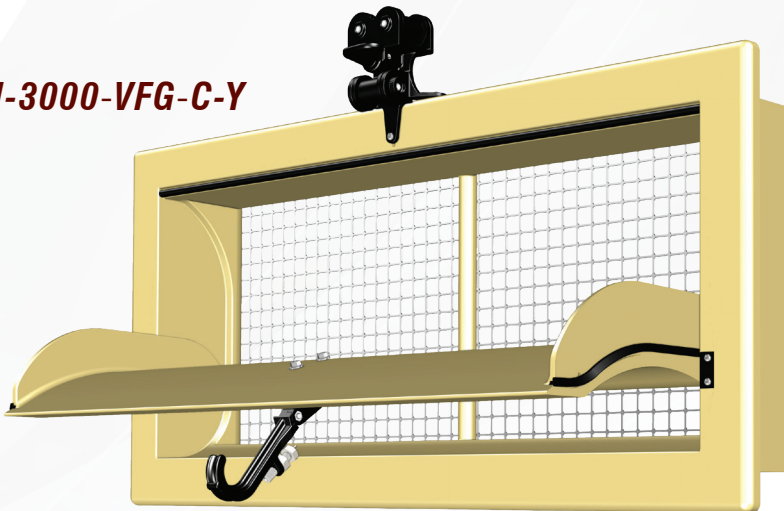

**TPI-3000-VFG-C-Y Air Inlet**



**Rough Opening**  
34.45" W x 15.55" H

**TPI-4000-VFG-C-Y**

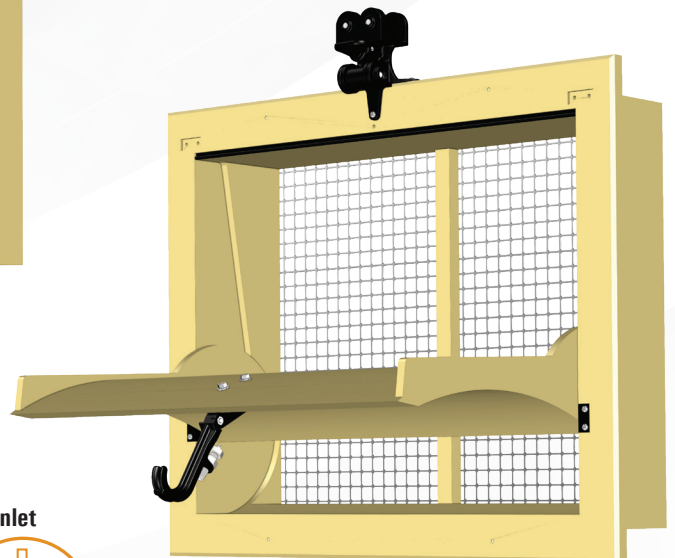

**TPI-4000-VFG-C-Y Air Inlet**

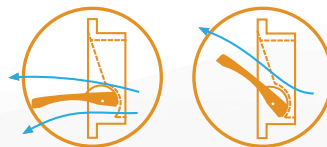

**Rough Opening**  
28.35" W x 22.44" H

# Large Wall Inlets



These inlets are developed for use in wide houses, or houses with obstacles. Due to the adjustable louvers, the airflow can be directed in any desired direction independent of the required capacity.

- **Bi-Directional Tunnel Unit:** equipped with a curved inner valve that guides the air upwards during minimum ventilation
- **Omniflux:** has unique sliders and guide rails that make sure the profiled sliding plate of the inlet never gets stuck
- Get more CFM for your building needs

Part#	Louver Orientation	CFM @			m <sup>3</sup> /h			Force	
		.05" SP	.10" SP	.15" SP	10 Pa	20 Pa	40 Pa	Nw	Run
TPI-OMNIFLUX-Y	Horizontal	2,106	2,922	3,638	3,200	4,450	6,400	44.1	16.5"
	1 Dir. @ 30°	1,481	2,102	2,529	2,250	3,200	4,450		
	2 Dir. @ 30°	1,415	1,970	2,472	2,150	3,000	4,350		

Part#	CFM @			m <sup>3</sup> /h			Force	
	.05" SP	.10" SP	.15" SP	10 Pa	20 Pa	40 Pa	Nw	Run
TPI-6000-VFG-4-C-Y	15,267	22,986	26,372	23,200	35,000	46,400	137.3	15.7"

All TPI Inlets come in Yellow or Black. To order Black color, change ".Y" to ".B" at the end of the part number.

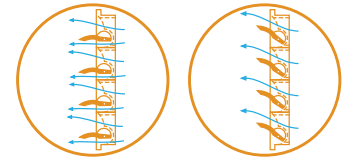

**TPI-6000-VFG-4-C-Y  
Tunnel Unit**

## TPI-Omniflux-Y

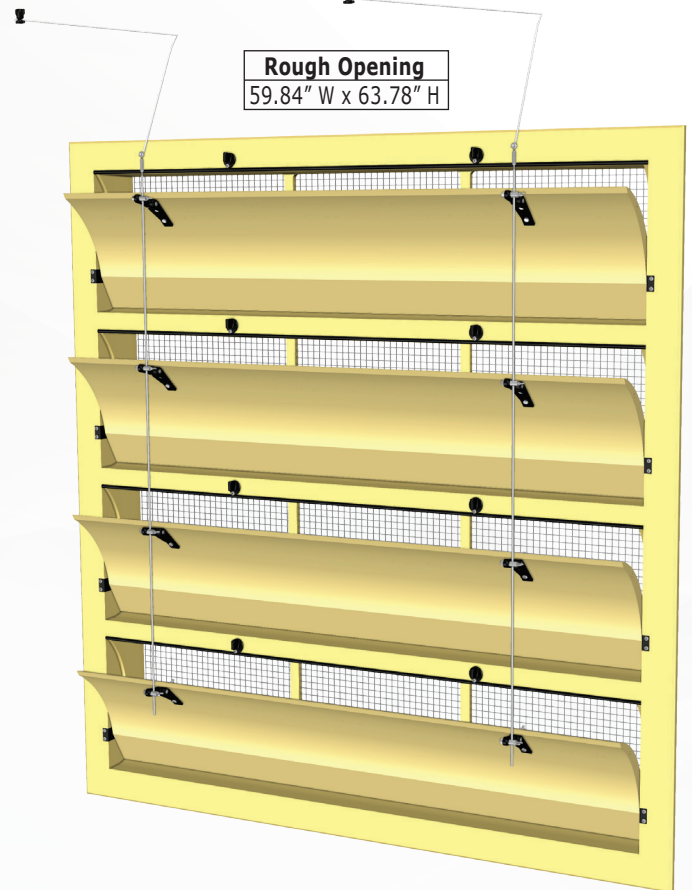
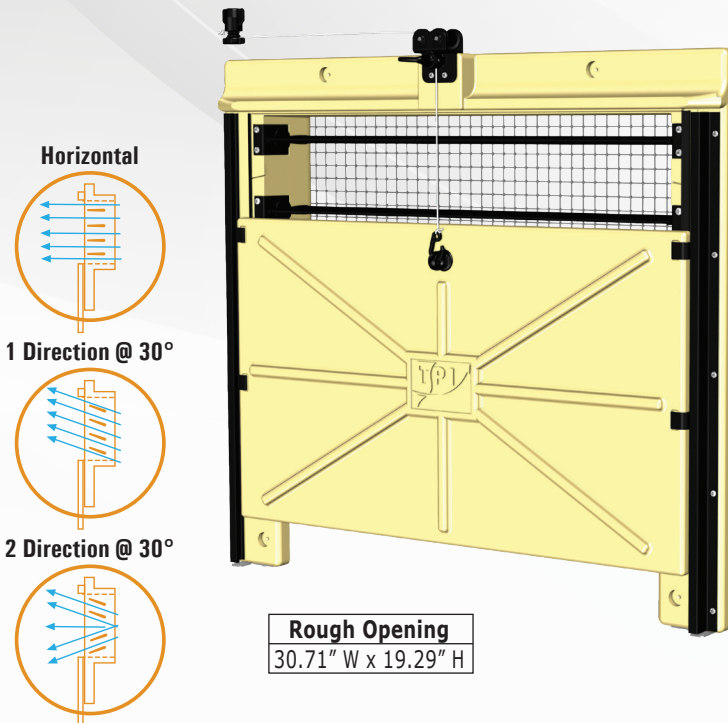

# Ceiling Inlets



These impressive ceiling inlets are specifically designed for bringing air from the attic into the house. This allows the air to 'preheat' before entering the livestock environment.

- Prevent condensation
- Low temperature transference
- The curb deflects air back down towards the curve of the door for better air control
- Doors are cupped shaped with side shields to direct air out and up – allowing the air to properly mix before sinking to livestock level

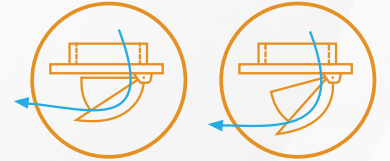

**TPI-160-P-C-Y**

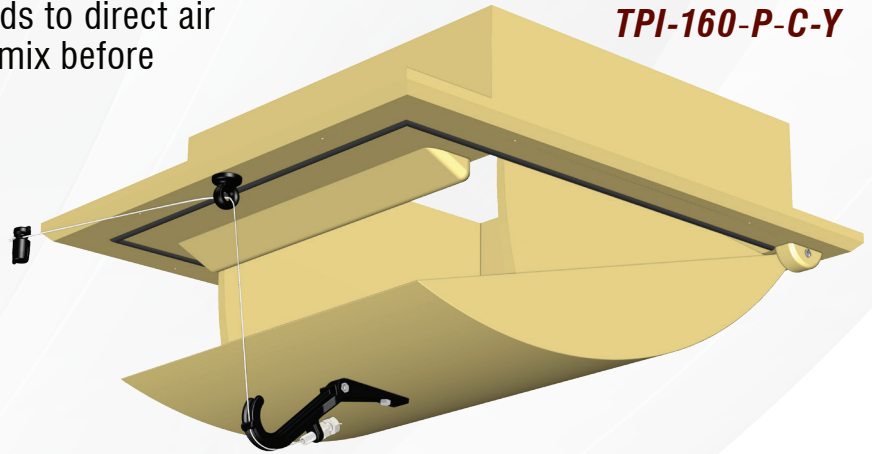

**TPI-160-PD-C-Y**

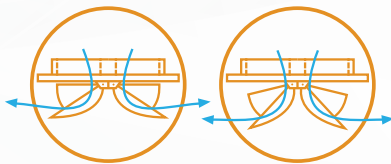
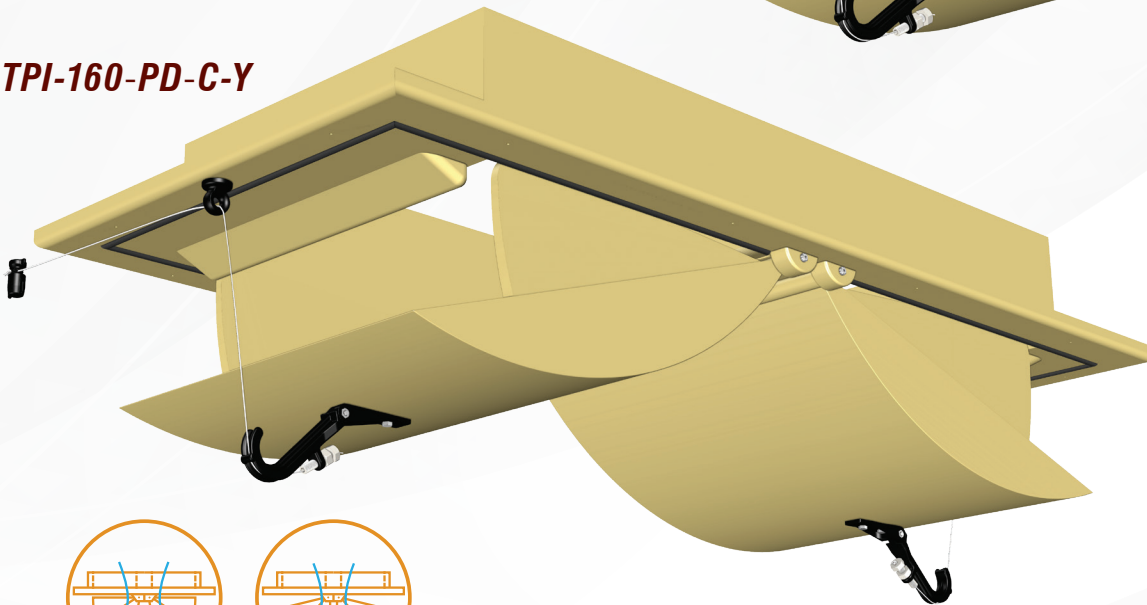

All TPI Inlets come in Yellow or Black. To order Black color, change "Y" to "B" at the end of the part number.

Part#	CFM @			m <sup>3</sup> /h			Rough Opening	Force Nw	Run
	.05" SP	.10" SP	.15" SP	10 Pa	20 Pa	40 Pa			
TPI-160-P-C-Y	1,053	1,478	1,819	1,600	2,250	3,200	20.28" W x 18.50" L	14.7	7.9"
TPI-160-PD-C-Y	2,106	2,955	3,638	3,200	4,500	6,400	20.28" W x 39.76" L	14.7	7.9"



#Request  
The Test

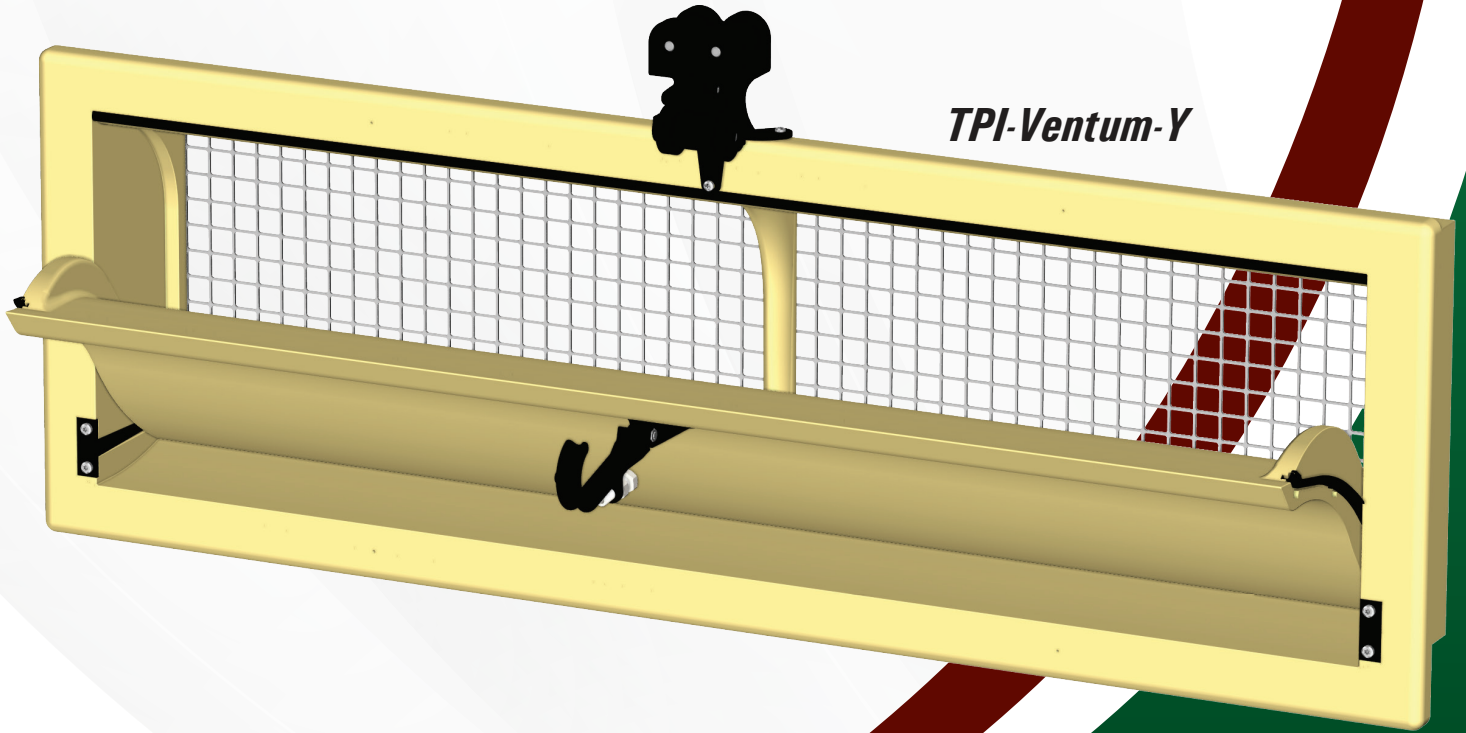

*TPI-Ventum-Y*

**YOUR  
VENTILATION  
EXPERTS**



**J&D  
Manufacturing**

6200 US-HWY 12, EAU CLAIRE, WISCONSIN 54701



Family Owned & Operated in Eau Claire, Wisconsin

1-800-998-2398 | [www.jdmfg.com](http://www.jdmfg.com)