

# Gate Hinge Pins & Pocket Mounts

J&D Manufacturing's Hinge Pin Pocket Mounts give you the flexibility you need when installing your J&D Steel Make-A-Gates. Pocket Mounts fit our standard HGF150 hinge pins, and can be fully adjusted AFTER installing your gates.

## Features

- Hot dip galvanized for long life
- Quick and easy installation
- No restrictions for weight or length of gate
- Bolt-on or weld-on mounts
- Flat or round surface mounts
- Hinge pockets for 1 5/8", 1.9", and 4" post
- Sold in pairs

**Pocket mounts for nearly any J&D Steel Make-A-Gate installation situation.**

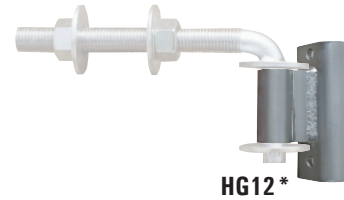
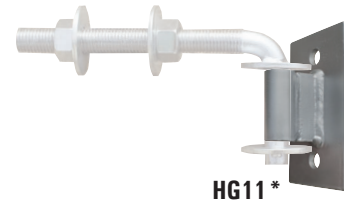
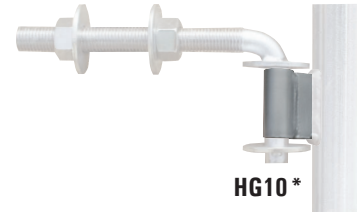
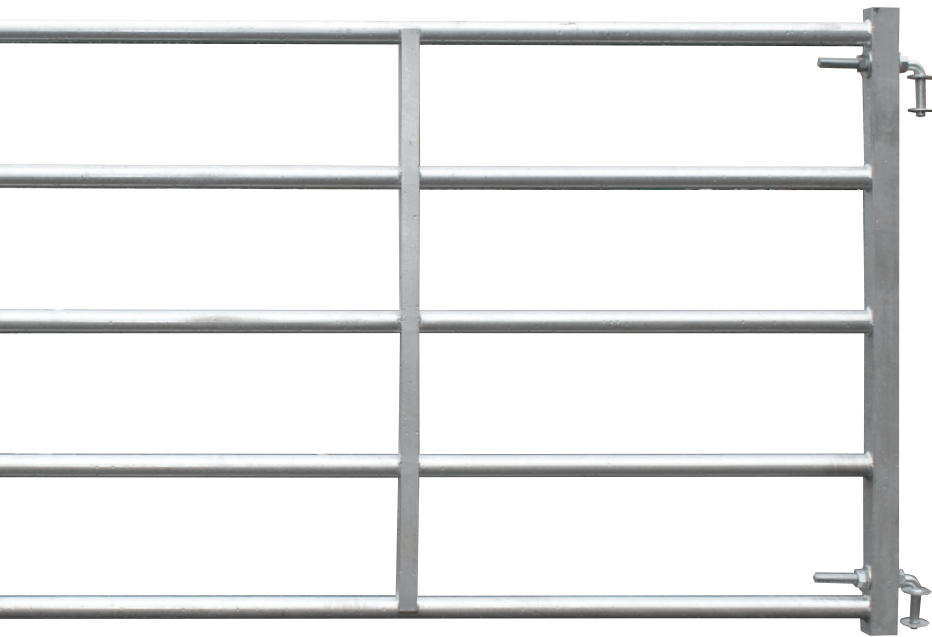

Part#	Description
<b>Hinge Pins</b>	
HGF150	(2) Hinge, Gate Thru Bolts Male End, HDG, with Hardware
<b>Hinge Pin Pocket Mounts *</b>	
HG10	(2) Hinge Pocket, Weld On, Mount to Flat or Round Surfaces, Zinc Plated
HG11	(2) Hinge Pocket, Bolt On, Mount to Flat Surface, Zinc Plated
HG12	(2) Hinge Pocket, Bolt or Weld On, Mount to Flat or Round Surfaces, Zinc Plated
HGF330	(2) Hinge Pocket Mount, Bolt On, Mount to 1 5/8" Post, HDG, with Hardware
HGF331	(2) Hinge Pocket Mount, Bolt On, Mount to 1.9" Post, HDG, with Hardware
HGF335	(2) Hinge Pocket Mount, Bolt On, Mount to 4" Post, HDG, with Hardware

\*Pocket mounts are pictured using the HGF150 hinge pin for display purposes only. The HGF150 is not included with the hinge pocket mounts.

**⚠ WARNING:** This product can expose you to chemicals including lead, which is known to the State of California to cause cancer and birth defects or other reproductive harm. For more information go to [www.P65Warnings.ca.gov/product](http://www.P65Warnings.ca.gov/product).

# Round Tube Bolt-On Gate Hinges

J&D's round tube gate hinges provide a flexible option when hanging your gates. The bolt-on design allows you to adjust the gate height at any time without drilling new holes or creating a new weld.



## Features

- Hot dip galvanized for long life
- Quick and easy bolt-on design
- Hinges to mount 1 5/8" or 1.9" tubes to 1 5/8", 1.9", or 4" posts
- Sold in pairs with mounting hardware

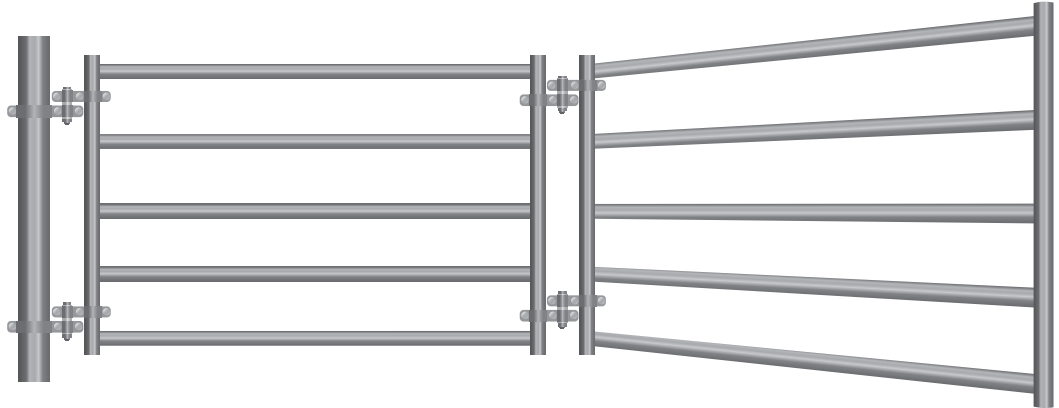

## Round Tube Bi-Fold & Bi-Fold Foldaway Gate Hinges

Bi-fold hinges from J&D Manufacturing turn your round tube gates into a custom bi-fold foldaway gate. The bolt-on design allows you to adjust the gate height at any time without drilling new holes or creating a new weld. Bi-fold gates give you greater control when directing livestock traffic flow.

## Features

- Turn your round tube gate into a custom bi-fold or bi-fold foldaway gate!
- Hot dip galvanized hinges
- Quick and easy bolt-on design
- Fits gates with 1 5/8" or 1.9" round tubes
- Sold in pairs with mounting hardware

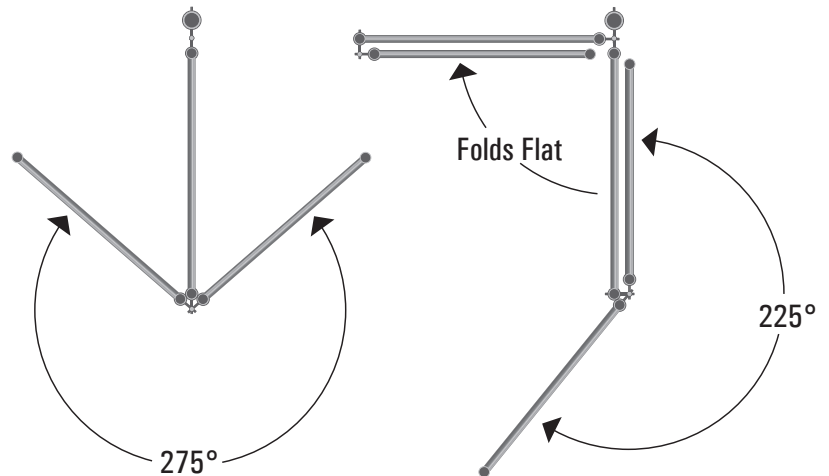

Mount hinge on the end of the gate to create a bi-fold with a 275° swing.

Mount hinge on the left or right side of the gate to create a bi-fold that will swing flat and fold completely away.

## Round Tube Bolt On Gate Hinges

Part#	Description
HGF340	(2) Bolt On Hinges, 1.9" Tube to 4" Post, HDG, w/Hardware
HGF341	(2) Bolt On Hinges, 1.9" Tube to 1 5/8" Post, HDG, w/Hardware
HGF342	(2) Bolt On Hinges, 1.9" Tube to 1.9" Post, HDG, w/Hardware
HGF343	(2) Bolt On Hinges, 1 5/8" Tube to 4" Post, HDG, w/Hardware
HGF344	(2) Bolt On Hinges, 1 5/8" Tube to 1 5/8" Post, HDG, w/Hardware

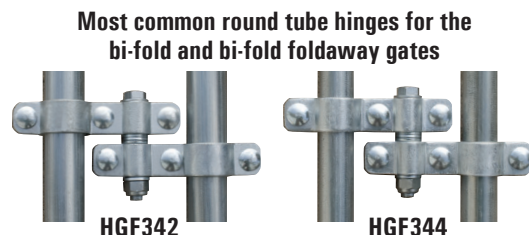

**⚠ WARNING:** This product can expose you to chemicals including lead, which is known to the State of California to cause cancer and birth defects or other reproductive harm. For more information go to [www.P65Warnings.ca.gov/product](http://www.P65Warnings.ca.gov/product).