

ZP2-HC-ESP Installation and Operation Instructions

1 Heat / 1 Cool - Auto Changeover First Call Priority - Time Share with Integrated ESP Static Pressure Module

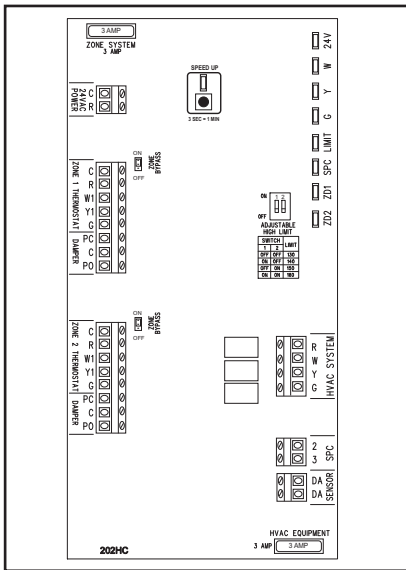

OVERVIEW:

The ZP2-HC-ESP is a residential/light commercial zone control panel that includes integrated ESP static pressure control logic designed to eliminate the need for a conventional bypass damper when used with 3-wire zone dampers.

SEQUENCE OF OPERATION:

The panel allows a single HVAC unit to have up to two separate zones. Each zone is controlled by its own thermostat. When a zone thermostat calls for heating or cooling, the zone not calling will have its dampers powered closed, and the zone calling will have its dampers powered opened. The heating or cooling equipment will also be brought on.

As zone dampers open and close, the ZPA-SPS Static Pressure Sensor continuously monitors the system static pressure. If the static pressure goes above the static pressure setpoint, the panel will send a signal to the non-calling zone damper to start to open to a point where the static pressure setpoint is maintained. The SPS LED will come on with the non-calling zone LED until the static pressure reaches setpoint. The small amount of air allowed to bleed into non-calling zone eliminates air noise and assures proper airflow through the HVAC system. This also prevents coil freeze up and high temperature issues. When all calls are

satisfied, all zone dampers will go to the full open position provided none of the thermostats are calling for ventilation mode. If opposite calls take place, the first zone to call receives priority. When the first call is satisfied, the system will changeover and take care of the opposite call. If zones being served (heating or cooling) have not been satisfied within 20 minutes while an opposite call is taking place, the system will changeover. When the zone is satisfied or 20 minutes has elapsed, the system will again changeover if an opposite call exists. This is referred to as Auto-Changeover - First Call Priority - Time Share. In the event of a tie, cooling will receive priority.

HIGH AND LOW LIMIT PROTECTION:

A ZPA-DTS Discharge Temperature Sensor should be mounted on the discharge air plenum of the HVAC unit and wired to the DA terminals on the panel. The sensor is used for both high (adjustable) and low (fixed) limit protection. The high limit setting can be adjusted using the two slide switches located on the panel. (See switch location and settings on page 2) Low limit is fixed at 45° F. When the discharge air temperature rises above the high limit setting or falls below the low limit setting, the panel will cycle the equipment off while the fan continues to run. The LIMIT LED blinks when high or low limit is reached. In cooling mode, a 3 minute time delay is activated to prevent short cycling of the equipment.

VENTILATION MODE:

Zone ventilation is established by the individual zone thermostat fan setting. When no calls are taking place, any thermostat set in the fan AUTO mode will not receive ventilation air and its zone damper will be closed. Any zone thermostat set in the fan ON mode will receive ventilation air and its zone damper will be opened. Heating or cooling calls take priority over ventilation mode. The ESP function will continue to maintain the system static pressure by modulating open the non-calling ventilation zone as required.

POWER REQUIREMENTS:

The panel is powered by a single 24VAC, 40VA transformer. Never use the equipment transformer.

ZP2-HC-ESP Panel Layout

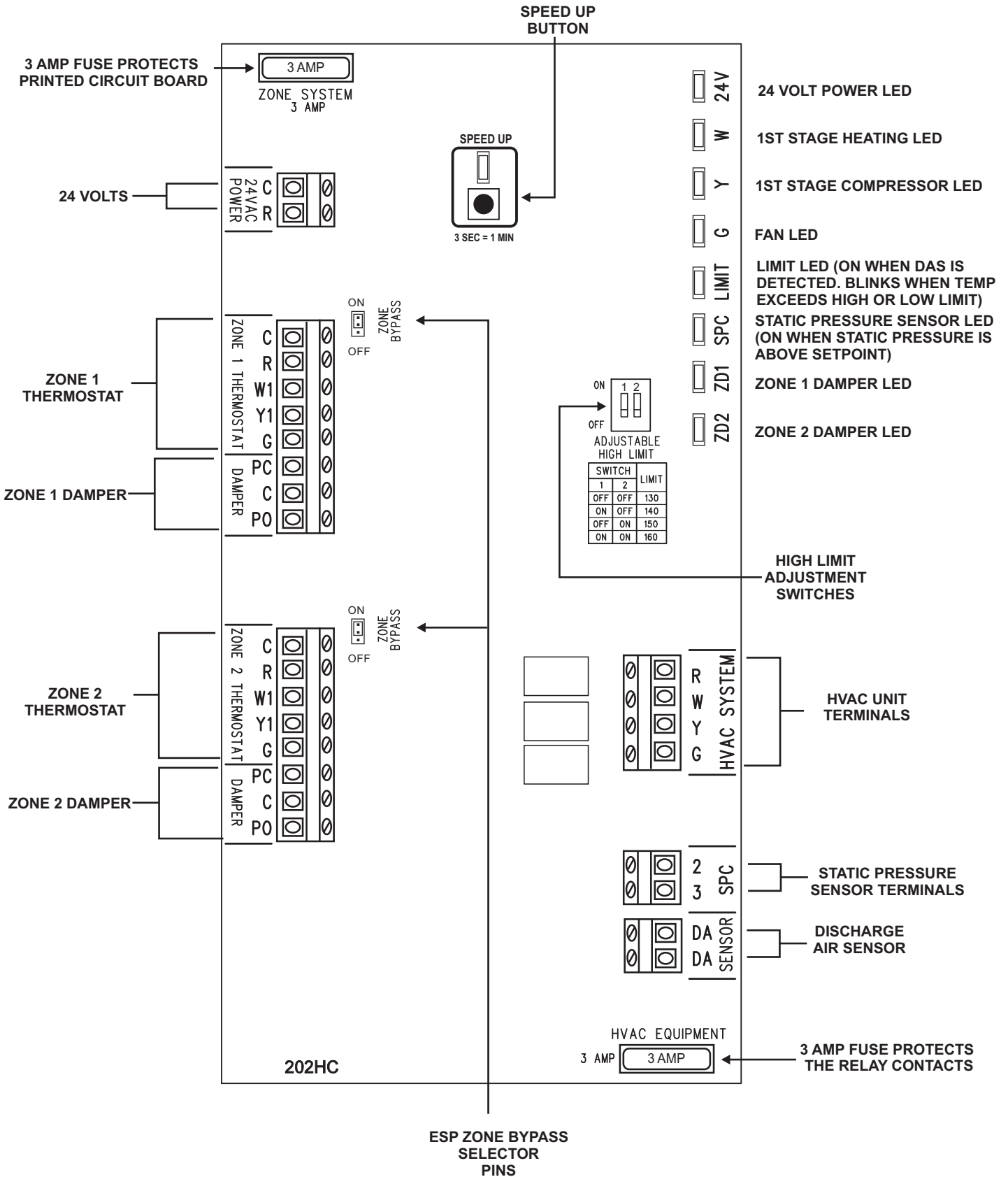

ZP2-HC-ESP TERMINAL DESIGNATIONS

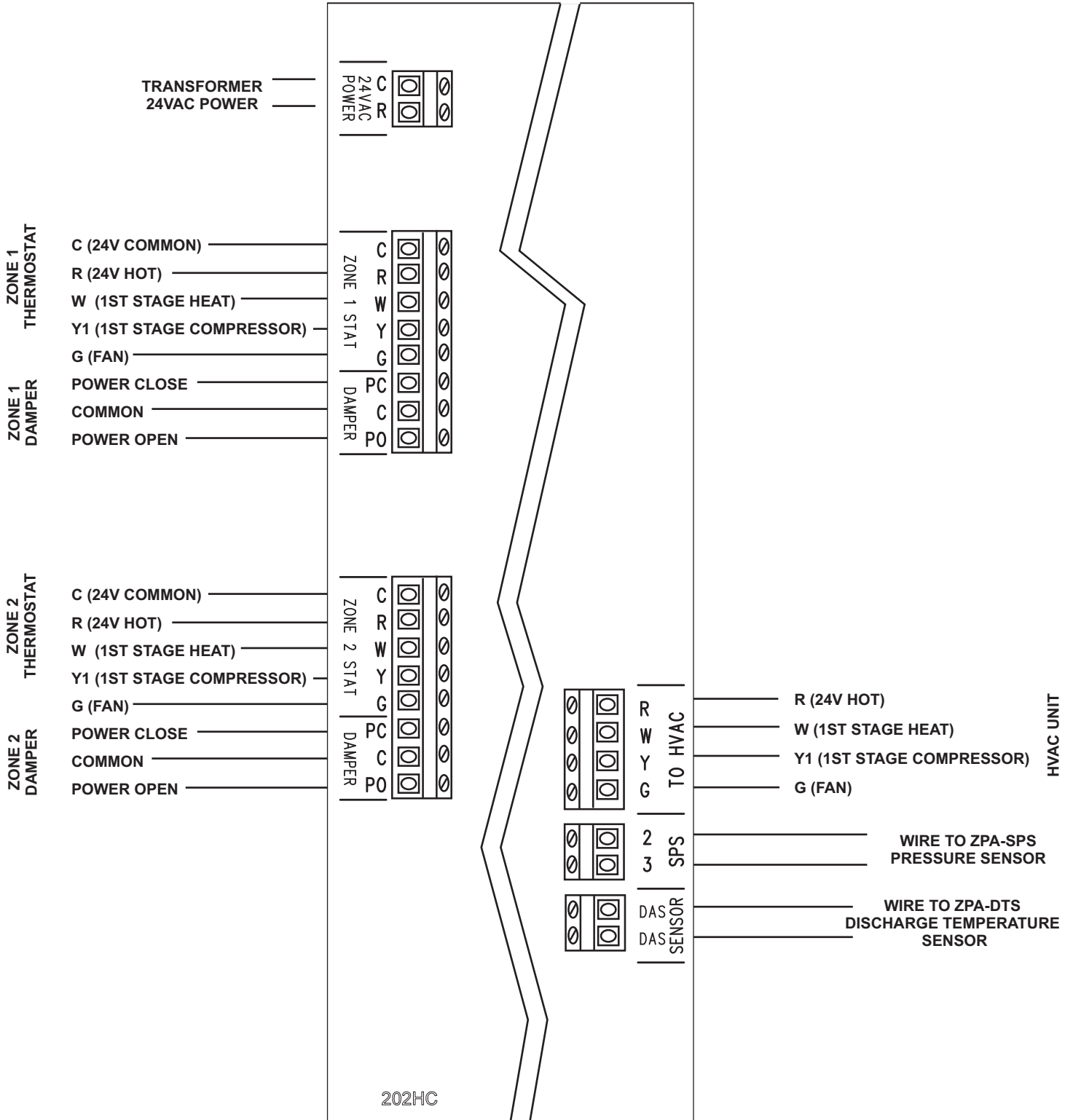

ZP2-HC-ESP LED STATUS DEFINITIONS

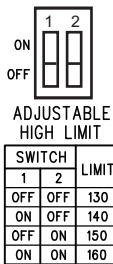
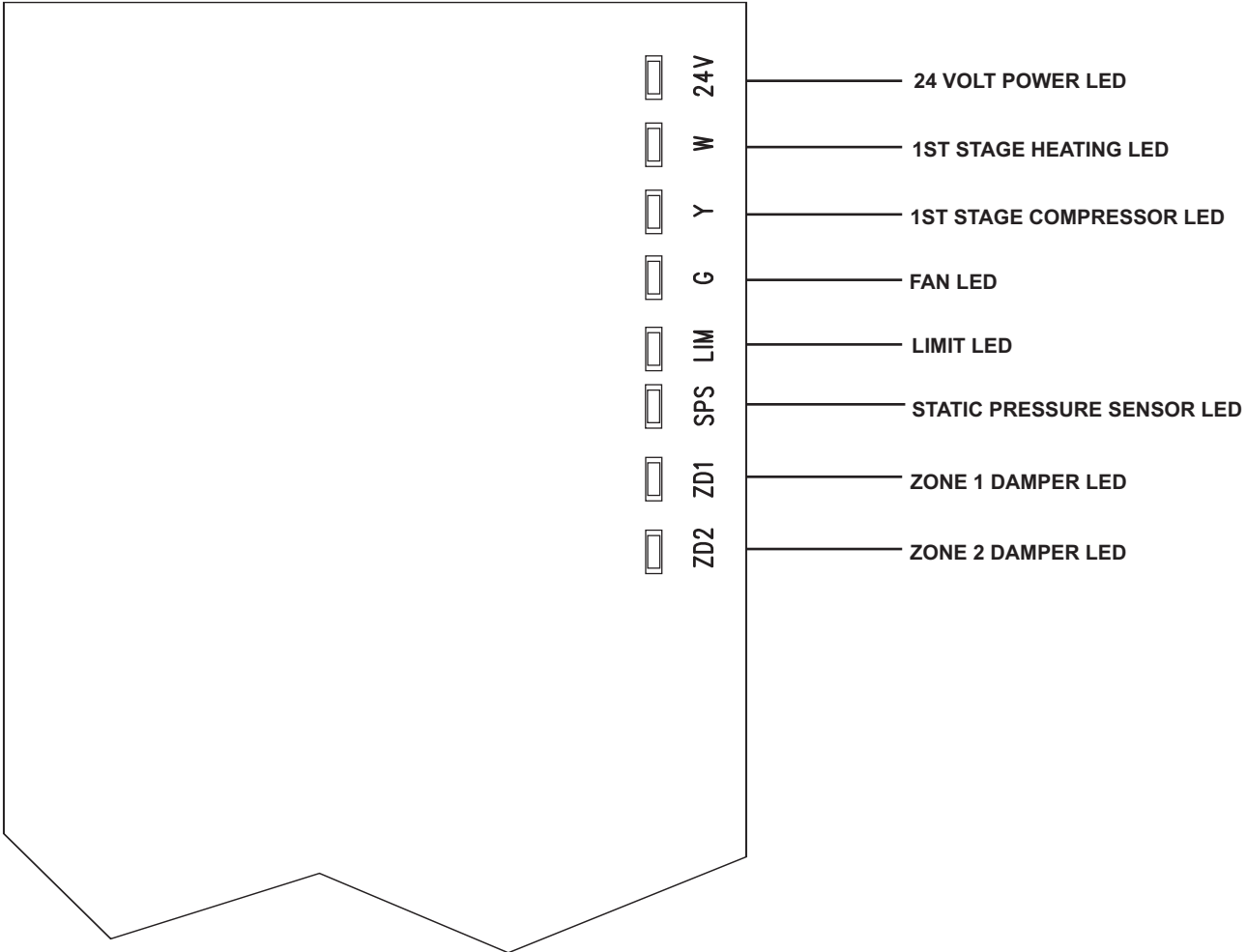

ADJUSTABLE HIGH LIMIT

High Limit adjustment switches are located on the panel. The switches can be set to provide limit protection below the safety limit on the furnace.

SPEED UP BUTTON

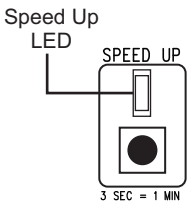

The Speed Up button can be used to put the internal panel time delays in speed up mode. When the button is pushed, the Speed Up LED will blink. Pushing the button again will reset the time delays and the LED will turn off or will automatically reset in 10 minutes.

ESP ZONE BYPASS SELECTOR PINS



Each zone has an ESP Zone Bypass selector pin. The panel comes from the factory with all zones set to ON. By placing a zones selector pin in the OFF position, this will prevent air from bleeding into the zone when it is not calling even if the static pressure goes above the setpoint. This is sometimes useful for basement zones or zones with small CFM requirements providing other non-calling zones have the CFM capacity to allow enough air to bleed without causing air noise without over heating and cooling.

INSTALLING AND WIRING THE ZP2-HC-ESP

MOUNTING THE ENCLOSURE:

Carefully remove the panel from the shipping carton. Remove the cover and any packing material. Locate the panel on a flat, non-condensating, vertical surface near the indoor unit that will facilitate ease of wiring and service access. Use appropriate anchors and screws to secure the panel to the surface.

NOTE:

The panel utilizes home run wiring. Tag each zone thermostat cable and its associated zone damper cable to minimize wiring errors.

WIRING ZONE THERMOSTATS:

Use conventional 18-8 thermostat wire. After removing the outer jacket, strip approximately 1/8" insulation off of each wire. Land each wire to its designated screw terminal.

WIRING ZONE DAMPERS:

Use conventional 18-3 thermostat wire. After removing the outer jacket, strip approximately 1/8" insulation off of each wire. Land each wire to its designated screw terminal.

WIRING TO THE HVAC EQUIPMENT:

Use conventional 18-6 thermostat wire. After removing the outer jacket, strip approximately 1/8" insulation off of each wire. Land each wire into its designated screw terminal on the HVAC UNIT terminals.

Note: Do not wire the equipment common to the HVAC UNIT terminals on the panel.

INSTALLING AND WIRING THE ZPA-DTS DISCHARGE TEMPERATURE SENSOR:

Drill a 15/32" hole in the middle of the main discharge air plenum approximately 18" to 30" from the heat pump electric strip heater or the furnace heat exchanger in a fossil fuel application. Slide the discharge air probe into the hole and use two self-tapping sheet metal screws to secure the base to the plenum. Use conventional 18-2 thermostat wire and wire nuts to attach the sensor leads. Replace the cover with the wire nut connections inside. Strip 1/8" insulation off of each wire at the other end and

land the wires to the screw terminals marked DA on the panel.

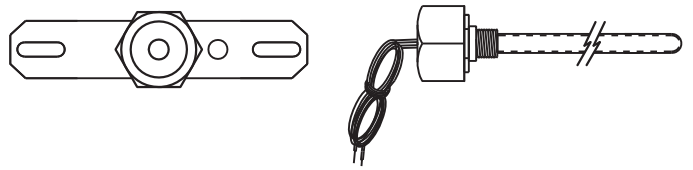

INSTALLING AND WIRING THE ZPA-SPS STATIC PRESSURE SENSOR:

The ZPA-SPS pressure sensor should be installed on a flat, surface so that the diaphragm is in the vertical position. Use the 1/4" x 36" tubing provided and connect one end to the (P1+) high pressure fitting on the sensor. The other end of the tubing should be connected to the plastic sensing probe mounted in the main discharge air plenum prior to any zone dampers or duct transitions. The sensing probe is 3-1/8" x 1/4" O.D. Install and mount the probe with the arrow in the direction of airflow. The ZPA-SPS is factory set for 0.35" W.C. but is fully adjustable from 0.08" to 1.20" W.C. The terminals are not polarity sensitive. Use 18-2 thermostat wire. After removing the outer jacket, strip approximately 1/8" insulation off of each wire. Land the wires to the 2 and 3 terminal on the pressure sensor. Repeat the process on the other end and land the wires to the screw terminals on the panel marked SPS 2 and 3.

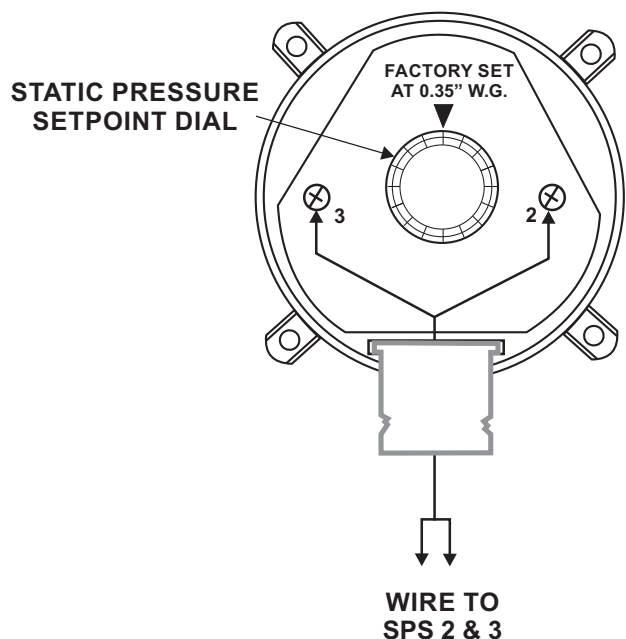

INSTALLING AND WIRING THE ZP2-HC-ESP

WIRING THE TRANSFORMER:

Wire the separate 24 Volt transformer to the 24VAC POWER 'R' and 'C' terminals. Use conventional 18-2 thermostat wire. After removing the outer jacket, strip approximately 1/8" insulation off of each wire. Land each lead to the 24VAC POWER screw terminals marked C and R.

TEST, CHECK AND STARTUP:

1. Verify that all component wires have been connected to the proper terminals and are secure.
2. Make sure that the selector switches on the panel are in their proper position.
3. Apply 24 Volt power to the panel.
4. Place all zone thermostats in the OFF mode with Auto fan.
5. With no calls taking place, the following panel LEDs should be lit:

24V
LIMIT
ZD1
ZD2

6. Visually confirm that all zone dampers are in the open position.
7. Place zone 1 thermostat in the continuous fan ON mode and the system blower should come on. The following panel LEDs should be lit:

24V
G
LIMIT
ZD1

Note: If system static pressure goes above setpoint, the SPS LED will light along with the selected non-calling zone LED until the non-calling zone damper modulates to relieve the static pressure then both LEDs will turn off.

8. Put zone 1 thermostat in Auto fan and repeat the same steps for zone 2. The only change in LED status will be ZD2 will light and ZD1 will turn off.
9. Once the ventilation test is completed, and the zone thermostat fan modes are set to Auto, place zone 1 thermostat in the cooling mode and adjust the setpoint above the space temperature until it calls for cooling. Keep in mind that the zone thermostat may have a time delay and that the panel has a 3 minute short cycle time delay before allowing the equipment to come on.

Once the cooling cycle is energized, the following panel LEDs should be lit:

24V
Y
G
LIMIT
ZD1

10. Repeat the same step for zone 2. LED status should be the same with the exception that ZD2 LED will be lit and ZD1 LED will turn off.
11. The same test can be done for a heating call from each zone.
12. Once testing is confirmed, place zone thermostats in their proper mode of operation.

ZP2-HC-ESP SPECIFICATIONS:

Enclosure:

Aluminum

Panel Dimensions:

Height: 8.0"

Width: 6.0"

Depth 2.25"

PC Board Mounting:

Individual Snap Track mounted to enclosure base

Operating Temperature Rating:

-40° F to 150° F

Operating Humidity:

5% to 90% RH non-condensing

Wiring:

18-gauge wire for all equipment and component connections.

Time Delays:

3 minutes off between heating and cooling calls.

3 minutes off on high or low limit

20 minute time share

Thermostats:

Single Stage

Programmable or non-programmable

Auto or manual changeover

Sensors:

ZPA-DTS Discharge Temperature Sensor

NTC Type 3, 10K Ω @ 77° F, +/- 3% @ 77° F

FIELD WIRING TERMINALS:

Zone Thermostats:

C 24Vac (Common)

R 24Vac (Hot)

W First Stage Heat

Y First Stage Compressor

G Fan

HVAC Equipment:

R 24Vac Equipment Hot

W First Stage Heat

Y1 First Stage Compressor

G Fan

High / Low Limit

DA Land to ZPA-DTS

DA Land to ZPA-DTS

Panel Power:

C 24Vac (Common)

R 24Vac (Hot)

Damper Outputs

PC Power Close

C Common

PO Power Open

Pressure Sensor:

2 Land to ZPA-SPS

3 Land to ZPA-SPS



HVAC Controls
Indianapolis, IN 46237

www.iohvaccontrols.com
For Technical Support Call Toll Free: 866-225-5032

IO-06-1281-010818