

SPECIFICATION SHEET

MD-XXXX Rectangular, 3-wire Floating Point Motorized Zone Control Dampers

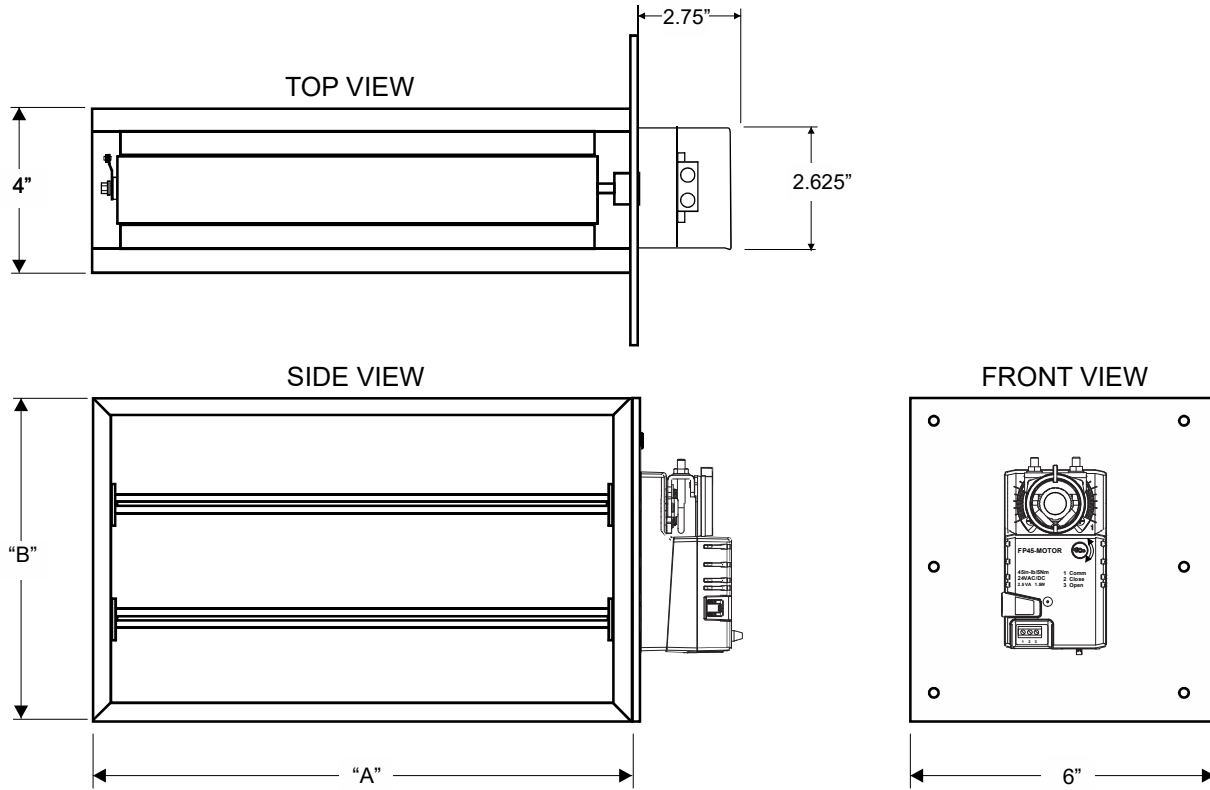

SPECIFICATIONS

DIMENSIONS:

Damper models MD-XXXX are sized width (A) by height (B) with actuator on the (B) dimension. Bottom mount models MD-XXXX-BM are sized width (A) by height (B) with actuator on the (A) dimension. Actual (A) and (B) dimensions are undercut 1/4". Standard sizes range from 8" x 8" up to 36" x 24" in 2" increments.

APPLICATION:

Used with all iO HVAC Controls ESP zone control panels and can be used with other panels using a 3-wire damper.

CONSTRUCTION:

- 1/16" extruded aluminum frame
- 1/16" extruded aluminum parallel blades
- 1/16" aluminum mounting flange
- Nylon bushings
- Minimum position adjustment

ELECTRICAL:

- 24Volt, 2.1 VA
- 3-Wire
- 60 second timing
- 45 lb.-in.

Drawings are intended to show general, overall product dimensions and provide guidance for installation clearance. Drawings are not to scale. iO HVAC Controls reserves the right to make product changes without notification or obligation.