

building value in air

WORLDWIDE



 **GREENHECK**
Building Value in Air.



At Greenheck, being the easiest company to do business with is not just a catch phrase. It is a core value that we carry out every day in delivering the widest range of reliable air movement, control, and conditioning products to our customers worldwide. As an industry-leading manufacturer, not only do we build value in air through our products, we also do so by exceeding your expectations for on-time delivery, easy installation, energy-efficient operation, and dependable performance.

Through our commitment to sustainable manufacturing practices that reduce energy consumption and production costs, we ensure competitive prices. We support and invest in our highly skilled employees so they can design and produce the quality products you expect from Greenheck. And we tackle the industry's most complex and everchanging challenges by continually manufacturing innovative new products that meet your needs today — and tomorrow.

Our Mission: To be the market leader in the development, manufacture and worldwide sale of quality air-moving, control and conditioning equipment with total commitment to the customer.

Our Purpose: To operate profitable businesses focused on delivering the most effective and efficient products, services and systems to ensure air quality and comfort in the world's buildings.

Our Vision: To be one of the most revered companies in the worldwide HVAC and food service market space, respected for outstanding product quality, market-leading innovation, superb customer service and insight, and a results-oriented, entrepreneurial culture.

Building value in air — from the beginning.

Today, Greenheck is the world's largest manufacturer of commercial, institutional, and industrial air movement, control, and conditioning equipment.

Greenheck's worldwide leadership in providing cost-effective, value-added solutions for air movement, control and conditioning challenges evolved from rather humble beginnings. Bernie and Bob Greenheck weren't sure what lay ahead when they opened their small sheet metal shop in Schofield, Wisconsin USA in 1947. But they were determined that no product would ever leave their shop unless it met the most stringent quality standards—their own. At first, the company manufactured a variety of sheet metal products. In 1956, Greenheck engineers developed a highly efficient power roof ventilator. This product and the innovative ventilation solutions that followed ultimately enabled us to expand our brand throughout the world. Today, quality Greenheck products are efficiently moving, conditioning, and controlling air in commercial, institutional, and industrial buildings throughout North America, Latin America, the Middle East, and Asia.



The first factory.
1947



Bernie and Bob Greenheck
1956

Customer-driven employees.

Every product is designed and built with pride by our employees.

Greenheck employees continue to share an extraordinary commitment to meeting and exceeding customers' expectations. We know our future success depends on the value we bring to the market: reliable, top-quality products and exceptional service. At our headquarters in Schofield, Wisconsin USA, and at additional plants in Frankfort, Kentucky; Rocklin, California; Kings Mountain and Shelby, North Carolina; Tulsa, Oklahoma; Saltillo, Mexico and Bawal, India, you'll find thousands of hardworking and experienced employees designing, manufacturing, and delivering the most dependable air movement and control equipment available.

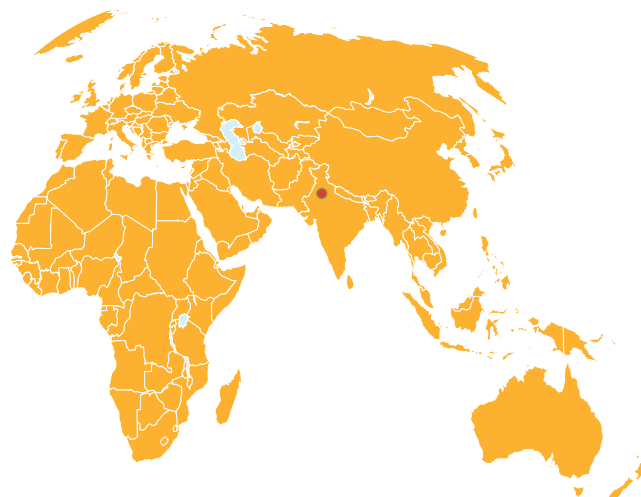

● Manufacturing

Schofield, WI	Shelby, NC
Rocklin, CA	Tulsa, Oklahoma
Frankfort, KY	Saltillo, Mexico
Kings Mountain, NC	Bawal, India

● National Distribution

Schofield, WI	Miami, FL
Rocklin, CA	Greensboro, NC
Dallas, TX	

● International Distribution

Mexico	India
--------	-------

Engineering value — into every product.

Our innovative engineers continuously explore more cost-effective, value-added product solutions.



At Greenheck, we don't "value engineer." We engineer value into all our products by understanding—and meeting—our customers' needs. Our engineers continuously develop and introduce new products based on the input received from Greenheck's extensive network of manufacturing representatives who listen carefully to what you need. Using state-of-the-art computer modeling and extensive prototype testing, our engineers ensure our products exceed customer expectations by offering more efficient performance and easy, lower-cost installation. Whether a compact, quiet fan with the lowest industry sound levels, kitchen exhaust systems that trap more grease, the most advanced high volume low speed (HVLS) fan on the market, or more effective laboratory exhaust systems, Greenheck listens and delivers.

Thoroughly tested to ensure top performance and unequaled reliability.

Product testing and certification is of utmost importance in our development of quality air movement and control equipment. As a result, Greenheck offers more products with AMCA, UL, CE, NOM, ETL, CSA and ULc certifications than any other manufacturer in the HVAC industry. We maintain four third-party registered air chambers and a registered sound-testing facility in-house to ensure Greenheck products fulfill customers' expectations. We can also test louver and damper performance on-site with extensive dynamic water tests and missile impact tests.

Even components such as bearings, pulleys, and motors used in Greenheck products must meet the industry's highest standards for reliability and endurance.

Finite element analysis image showing blade stress distribution

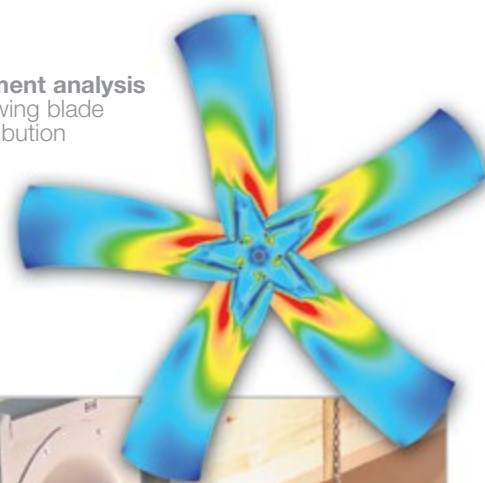

Robert C. Greenheck Innovation Center



The world's most comprehensive line of air movement, control, and conditioning products.

No other manufacturer offers you more air movement, control, and conditioning options than Greenheck. We strive to earn your trust through our commitment to providing industry-leading products that stand at the forefront of technology and performance. Our dedicated team of knowledgeable product managers, talented engineers and experienced customer service personnel work together to provide you with the finest products in each of our product areas:

- Roof Mounted Fans & Gravity Ventilators
- Inline, Ceiling & Sidewall Fans
- High Volume Low Speed (HVLS) Fans
- Vari-Green® Motors & Controls
- Utility, Centrifugal & Radial Blowers
- Fume Exhaust Systems
- Laboratory Exhaust Systems
- Kitchen Ventilation Systems
- Energy Recovery Ventilators
- Make-Up Air
- Dedicated Outdoor Air Systems
- Indoor Air Handling Units
- Coils ● Duct Heaters
- Dampers ● Louvers

Greenheck's commitment to innovation enables us to continually provide customers with unique value-added features. Our engineers design and build much of the machinery and dies used in the production of our products. Our skilled, experienced production staff, working with advanced numerically controlled manufacturing systems, meet the most challenging requirements in the industry. And the company's 2.9 million square feet of manufacturing and office space guarantees Greenheck can meet worldwide demand now and in the future.



When you specify Greenheck, you're specifying quality.



Bernard A. Greenheck Education Center
Schofield, Wisconsin USA

The **value** of customer service.

At Greenheck, we embody being the easiest company to do business with—every day. Our dedicated customer care team works with you personally to ensure a smooth process from submittal to delivery. Technical information and other industry resources can be readily accessed through our online library. Our industry-leading CAPS® and eCAPS® product selection software programs allow you to easily select the best value product for your application.

Another important component of our customer service is training. Online classes through Greenheck's HVAC University ensure customers understand industry concepts and product specifics to make informed decisions. Greenheck Education Centers, located in Schofield, Wisconsin, and Saltillo, Mexico, offer visitors a tremendous learning experience through working product demonstrations and simulated and virtual installations of our air movement, control, and conditioning products.

Most products can be shipped in less than 24 hours.

Greenheck's Quick Delivery in-stock program can efficiently ship more than 1000 of the most in-demand products to your jobsite in less than 24 hours. In fact, most orders received before 2 p.m. Central Time will ship the same day!

For products requiring specific customization to meet project demands, Greenheck's Quick Build program ensures these products can be constructed in 1, 3, 5, 10, 15 or 25-day manufacturing cycles. Five strategically located Greenheck distribution centers across the United States ensure Greenheck products are readily available when you need them.



Education Center
Saltillo, Mexico

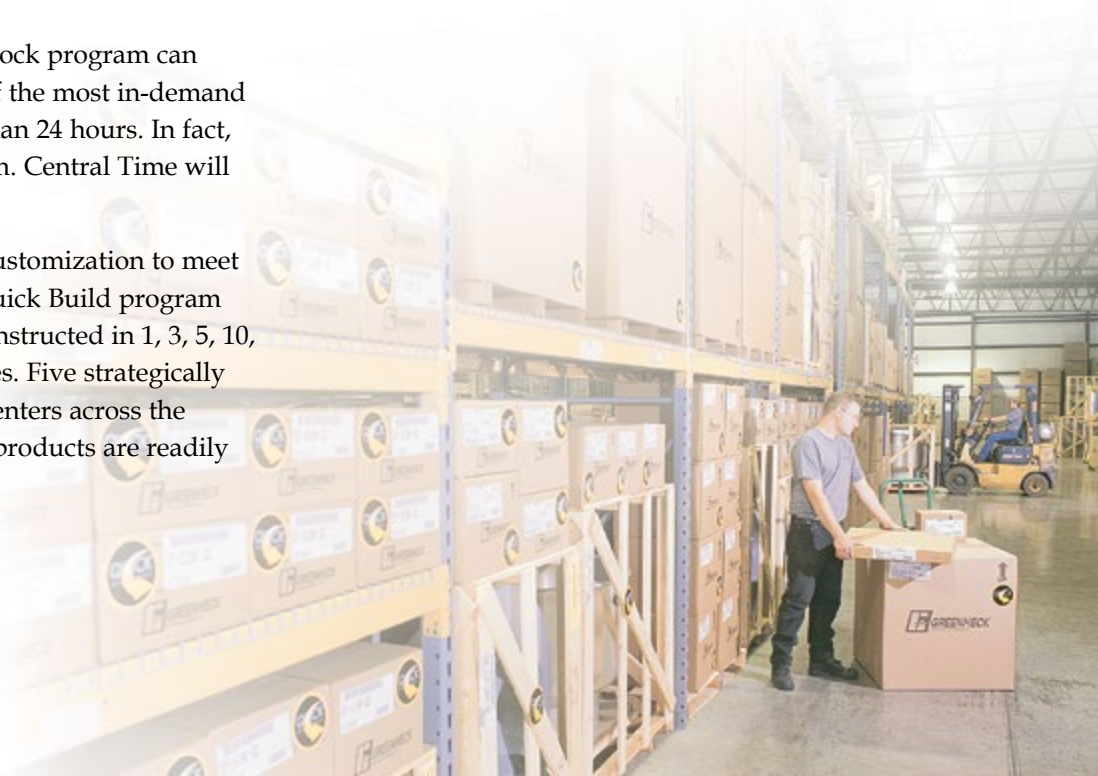

Our Products

Engineered and manufactured for
top performance — and value.

8



Roof Mounted
Fans and Gravity
Ventilators

13



Centrifugal Ceiling
and Cabinet, Exhaust
and Supply Fans

14



Centrifugal Inline,
Tubular, Mixed Flow
and Axial Fans

18

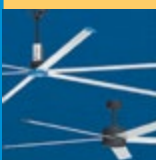

High Volume Low
Speed (HVLS) Fans

20



Sidewall Exhaust,
Supply and
Reversible Fans

21



Vari-Green® Motors,
Vari-Green Controls,
Vari-Green Drives
& Motor Starters

22



Utility, Centrifugal
& Radial Blowers

26



Fume Exhaust
Systems

27



Laboratory Exhaust
Systems

30



Kitchen Ventilation
Systems

34



Energy Recovery
Ventilators
Preconditioners

36



Dedicated
Outdoor Air
Systems

37



Make-Up Air

40



Indoor Air Handlers,
Fan Coils & Coils

42



Duct
Heaters

43



Dampers

51



Louvers

Roof Mounted Fans and Gravity Ventilators



Greenheck offers the world's widest selection of top quality fans and ventilators for commercial, institutional and industrial buildings. This selection offers you a vast variety of products to ensure you can always find the right fan to meet your precise performance requirements. Discover the value of a Greenheck fan with the world's best-selling centrifugal roof upblast and sidewall exhaust fans with one-piece, leakproof construction. Take advantage of our reputation for quality and reliability by experiencing one of our many Greenheck fan and ventilator products.

Centrifugal Roof Exhaust Fans

The centrifugal roof exhaust fans include both direct and belt-driven fans with backward-inclined centrifugal wheels. The fans feature double-studded isolators for true vibration isolation. The fans are a downblast configuration and are suitable for roof-mounted applications exhausting relatively clean air.

Models G/GB

Models G/GB feature a spun aluminum housing design. The Vari-Green® high-efficiency motor is available on model G direct drive fans. Capacities range from 50 to 45,000 cfm (85 to 76,455 m³/hr) and 3.25 in. wg (806 Pa). Third-party certified (Florida Product Approved and Miami-Dade County Qualified) for high wind and AMCA Licensed for Sound and Air Performance. IBC and OSHPD seismic certified. Select models with CE Mark.

Catalog: Centrifugal Roof Downblast Exhaust Fans — G and GB



Models LB/LBP

Model LB features a low silhouette housing design with “rib-lock” construction. Model LBP features an extruded aluminum louvered penthouse housing design (severe duty louvered enclosure). Capacities range from 925 to 37,500 cfm (1572 to 63,713 m³/hr) and 2.125 in. wg (529 Pa). AMCA Licensed for FEI, Sound and Air Performance.

Catalog: Centrifugal Roof Exhaust Fans — Series L (LB/LBP)

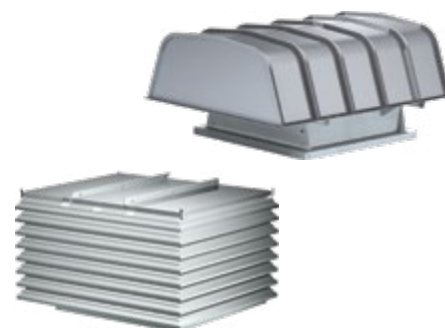

Centrifugal Upblast and Sidewall Exhaust Fans

The centrifugal roof upblast and sidewall exhaust fans include both direct and belt-driven fans with backward-inclined centrifugal wheels. The motors on the fans are out of the airstream. The fans are suitable for applications ranging from storage rooms and fume hood exhaust, to kitchen grease exhaust and smoke control.

Models CUE/CUBE - Roof or Sidewall Mounted

Model CUE/CUBE spun aluminum fans are specifically designed for roof or sidewall mounted applications. The fans feature a one piece windband continuously welded to the curb cap and double-studded isolators for true vibration isolation. Contaminated or grease-laden exhaust air is discharged directly upward, away from the roof surface or discharged out and away from building walls. The Vari-Green® high-efficiency motor is available on model CUE direct drive fans. Capacities range from 70 to 30,000 cfm (119 to 50,970 m³/hr) and 5 in. wg (1,240 Pa). Third-party certified (Florida Product Approved and Miami-Dade County Qualified) for high wind and AMCA Licensed for Sound and Air Performance. IBC and OSHPD seismic certified. Select models with CE Mark.

Catalog: Centrifugal Upblast and Sidewall Exhaust — CUE/CUBE



Model USGF

Model USGF (Ultimate Steel Grease Fan) is the ideal fan for heavy grease exhaust applications where high amounts of grease are used like charbroilers, solid fuel cooking, and oriental cooking. Constructed of steel, model USGF includes a nonstick coated steel wheel, steel windband, steel curb cap, and steel motor compartment. Standard features include UL 762 Listed, a heat baffle, clean-out port, dual belt and pulley system, and a mounted and wired NEMA-3R disconnect switch. The unit is powder coated for protection. Capacities range from 350 to 7,000 cfm (595 to 11,893 m³/hr) and 3.25 in. wg (809 Pa). Third-party certified (Florida Product Approved and Miami-Dade County Qualified) for high wind and AMCA Licensed for Sound and Air Performance.

Catalog: Centrifugal Upblast and Sidewall Exhaust — USGF



Propeller Tube Axial Fans

For low to medium pressure applications, tube axial fans include both direct and belt-driven fans with cast aluminum or fabricated steel blades. Propeller tube axial inline fans have a straight-through airflow, compact size and the flexibility to be mounted in any configuration—horizontal, vertical, or any angle. These fans are designed for reliable air movement in ducted commercial and industrial applications. The roof upblast configuration is designed to discharge contaminants up and away from the building in most applications.

Roof Upblast: Models RDU/RBU/RBUMO

Model RBUMO has its motor mounted out of the airstream and is suitable for high temperature emergency smoke removal (500°F/260°C for 4 hours or 1000°F/538°C for 15 minutes) and is available with UL Power Ventilators for Smoke Control Systems. The RBU/RBUMO has steel blades, and the RDU has cast aluminum blades. Capacities range from 2,800 to 68,000 cfm (4,757 to 115,532 m³/hr) and 1 in. wg (248 Pa). AMCA Licensed for Sound and Air Performance. RBUMO is IBC and OSHPD seismic certified.



Catalog: Propeller Upblast Roof Fans — RBU/RBUMO/RDU

Roof Upblast: Model TAUB-L/H

Model TAUB-L/H has its motor mounted out of the airstream and is suitable for high temperature emergency UL smoke removal. Typical applications include clean air, industrial processes, and high temperature exhaust. The TAUB-L/H has steel blades. Capacities range from 5,000 to 58,000 cfm (8,459 to 98,543 m³/hr) and 1 in. wg (248 Pa). For higher pressure capabilities use roof-mounted option on model TBI-FS. AMCA Licensed for Sound and Air Performance.



Catalog: Tube Axial Roof Upblast — TAUB

Roof Upblast: Models TAUD/TAUB-CA

Models TAUD/TAUB-CA have cast aluminum blades. Typical applications include clean air, fume exhaust, and spark resistant construction. Capacities range from 2,800 to 72,000 cfm (4,757 to 122,329 m³/hr) and 1.5 in. wg (373 Pa). For higher pressure capabilities use roof-mounted option on models TDI/TBI-CA or AX. AMCA Licensed for Air Performance.

Catalog: Tube Axial Roof Upblast — TAUD and TAUB-CA

Centrifugal Supply Fans

The centrifugal roof supply fans include filtered and nonfiltered belt-driven units. These fans are suitable for non-tempered kitchen make-up air or building supply air.

Model SAF

Model SAF filtered roof supply fan features a belt-driven, double-width, forward-curved, galvanized blower for low-cost, low sound, and high performance applications. Capacities range from 800 to 14,300 cfm (1,359 to 24,296 m³/hr) and 3.5 in. wg (868 Pa). AMCA Licensed for FEI, Sound and Air Performance.

Catalog: Centrifugal Roof Supply Fan — SAF

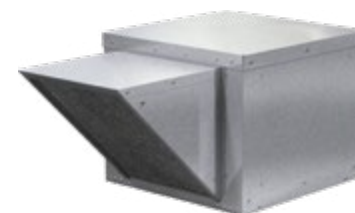

Models KSFB and KSFD

Models KSFB and KSFD economically supply untempered make-up air where needed. Kitchen make-up air applications are common and an extended weatherhood option provides a 10 foot separation between intake and exhaust fan discharge. Capacities range from 800 to 10,250 cfm (1,359 to 17,415 m³/hr) and 2.5 in. wg (622 Pa).

Catalog: Untempered Make-Up Air for Kitchen Systems — KSFB and KSFD

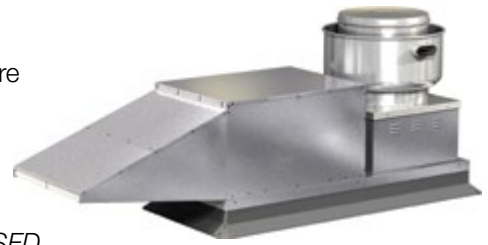

Models RSF/RSFP

Models RSF/RSFP fans feature forward-curved wheels designed for high efficiency and low sound. Housing styles include a straight-sided hood (RSF) or a louvered penthouse which features extruded aluminum louvers (RSFP). Capacities range from 600 to 16,300 cfm (1,019 to 27,694 m³/hr) and 2 in. wg (496 Pa). AMCA Licensed for FEI, Air Performance and Model RSF third-party certified (Florida Product Approved and Miami-Dade County Qualified) for high wind. IBC and OSHPD seismic certified.

Catalog: Centrifugal Roof Supply Fans — RSF and RSFP

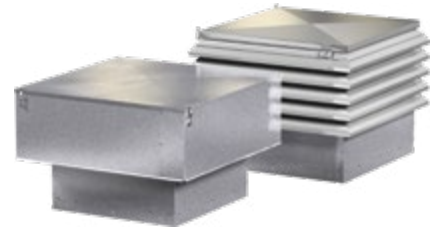

Hooded Propeller Exhaust and Supply Fans

The hooded roof propeller fans include both direct and belt-driven fans with fabricated steel, fabricated aluminum, or cast aluminum blades. These fans are suitable for clean air applications including exhaust, supply, or filtered supply. Typical applications are factories and warehouses.

Models R2/RC3/RB/RBC

Model R2/RC3/RB/RBC hooded roof propeller fans are available with a wide variety of accessories including tall bases, dampers and guards. Capacities range from 500 to 86,500 cfm (850 to 146,964 m³/hr) and 2 in. wg (498 Pa). Third-party certified (Florida Product Approved and Miami-Dade County Qualified) for high wind and AMCA Licensed for Sound and Air Performance. IBC and OSHPD seismic certified.

Catalog: Hooded Roof Propeller Fans — Exhaust, Supply and Reversible



Models RPDR/RPBR

Models RPDR/RPBR are compatible with ducted and non-ducted systems and offer the ability to exhaust or supply air on demand. Performance is equivalent in both the exhaust and supply modes. Capacities range from 2,900 to 70,500 cfm (4,927 to 119,780 m³/hr) and 0.5 in. wg (124 Pa). OSHPD seismic certified.

Catalog: Hooded Roof Propeller Fans — Exhaust, Supply and Reversible

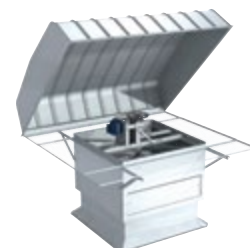

Models AE/AS

Model AE/AS axial roof exhaust and supply fans are designed for low volume, low pressure applications where a spun aluminum hood is desired. Capacities range from 150 to 6,000 cfm (255 to 10,194 m³/hr) and 1 in. wg (348 Pa). AMCA Licensed for Sound and Air Performance.

Catalog: Hooded Roof Propeller Fans — Series A (AE/AS)



Gravity Ventilators

The gravity intake and relief ventilators are non-powered and work on pressure differential between the inside and outside of the building.

Model GRS

Model GRS is an aluminum ventilator designed to be used as an intake (model GRSI) or relief unit (model GRSR) on natural gravity systems. The GRS appearance blends with other Greenheck products, and with its low silhouette, avoids the problem of detracting from architectural aesthetics.

Catalog: Gravity Ventilators — GRSI/GRSR



Models FGI/FGR

Models FGI (intake) and FGR (relief) have a low silhouette Fabra Hood design. The Fabra Hood design is superior in appearance, load-bearing strength, weather resistance, and dimensional flexibility. Third-party certified (Florida Product Approved and Miami-Dade County Qualified) for high wind.

Catalog: Gravity Ventilators — FGI/FGR



Models WIH/WRH

Model WIH (intake) and WRH (relief) units feature a stormproof aluminum louver with mitered corners. The louvered design affords lower pressure drops while maintaining low hood heights. The all-aluminum construction assures lasting durability and appearance. The removable hood is lined with insulation to prevent condensation.

Catalog: Gravity Ventilators — WIH/WRH



Centrifugal Ceiling and Cabinet, Exhaust and Supply Fans



Greenheck's ceiling and cabinet fans are direct drive models that have forward-curved wheels for low sound and high efficiency. They are suitable for clean air applications, such as bathroom exhaust fans, storage room, or office fans. Models are designed for commercial and multifamily construction. Centrifugal inline fans are ideal for clean air applications including intake, exhaust, return, or make-up air.

Ceiling and Cabinet Inline Fans

Model SP

Model SP is a direct drive ceiling exhaust fan designed for clean air applications where low sound levels are required. Many options and accessories are available including the Vari-Green® EC motor, lighted grilles, humidity detectors, ceiling radiation dampers and speed controls. Capacities range from 25 to 1,600 cfm (42 to 2,718 m³/hr) and 1 in. wg (248 Pa). AMCA Licensed for Sound and Air Performance. Many models are ENERGY STAR® Qualified and can be used to comply with ASHRAE 62.2 and California Title 24.

Catalog: Centrifugal Ceiling Exhaust and Inline Cabinet Fans — SP and CSP



Model SP-AP

Model SP-AP features a virtually silent electronically commutated (EC) motor with three built-in, high-speed airflow settings (50, 80, or 110 cfm). Its standard two-speed operation (commonly known as whole house ventilation) helps comply with ASHRAE 62.2, Washington State Energy Code and California Title 24 requirements. The fan is certified by Energy Star and the Home Ventilating Institute. Fan features allow for improved performance in a variety of installations. Options available include plug-and-play sensors (motion, humidity, nightlight, and CO₂) and lighted grilles.

Catalog: SP-AP Catalog



Model CSP

Model CSP is a direct drive inline fan designed for clean air exhaust or supply applications where low sound levels are required. Model CSP may be easily converted from horizontal to vertical discharge. The Vari-Green® EC motor is available for these models. Capacities range from 70 to 3,800 cfm (119 to 6,456 m³/hr) and 1 in. wg (248 Pa). AMCA Licensed for Air Performance.

Catalog: Centrifugal Ceiling Exhaust and Inline Cabinet Fans — SP and CSP



Centrifugal Inline, Tubular, Mixed Flow and Axial Fans



Greenheck's inline, ceiling, and sidewall exhaust or supply products are suitable for a wide range of commercial and industrial applications. Ceiling and cabinet fans are easily mounted in or above ceilings for efficient and quiet exhaust applications. Sidewall fans are wall-mounted supply or exhaust units suitable for clean or fume-laden air applications. Tubular centrifugal, axial and mixed flow inline products provide higher performance capacity than ceiling and sidewall fans. They are typically horizontally or vertically mounted in duct systems, but can be wall mounted, as well as roof mounted.

Centrifugal Inline Fans

Ceiling, cabinet and centrifugal inline fans include both direct and belt-driven fans.

Centrifugal inline fans have backward-inclined centrifugal wheels. Models feature rugged construction, high-efficiency, and low sound levels that are ideal for clean air applications, including intake, exhaust, return, or make-up air. They have straight-through airflow with compact size and have the flexibility to be mounted in any configuration—horizontal, vertical, or at any angle.

Model BCF

Model BCF is a belt drive inline low profile cabinet fan. It is designed for efficiency and reliability in supply, exhaust, and ducted return applications. Horizontal mounting with either top horizontal or upblast discharge allows the BCF to be applied in a wide range of applications. Capacities range from 170 to 5,850 cfm (289 to 9,939 m³/hr) and 1.5 in. wg (372 Pa). AMCA Licensed for FEI, Air Performance.

Catalog: *Centrifugal Cabinet Fans — BCF*



Model BDF

Model BDF is a belt drive duct fan designed for efficiency and reliability in supply, exhaust, or return air applications. Capacities range from 300 to 17,000 cfm (510 to 28,883 m³/hr) and 3 in. wg (744 Pa). AMCA Licensed for FEI, Sound and Air Performance.

Catalog: *Centrifugal Cabinet Fans — BDF*



Models SQ/BSQ

Models SQ/BSQ have a square housing design for indoor applications. Easy access for inspection and service is provided by removable side panels. Fans can be configured to discharge air 90 degrees from the inlet for tight space constraints. The Vari-Green® high-efficiency motor is available on model SQ direct drive fans. Capacities range from 50 to 27,000 cfm (85 to 45,873 m³/hr) and 4 in. wg (992 Pa). AMCA Licensed for FEI, Sound and Air Performance. Select models with CE Mark.

Catalog: *Centrifugal Inline Fans — SQ and BSQ*



Tubular Centrifugal Fans

Greenheck tubular centrifugal fans, model TCBRS and TCBRU, have been designed for commercial and industrial inline or roof upblast applications that demand quiet, efficient and reliable air movement. Tubular centrifugal fans are roof mounted on a roof curb.

Model TCBRS

Model TCBRS features aluminum backward-inclined wheels for quiet and efficient supply airflow. Greenheck's Fabra Hood housing on this model provides a strong, weathertight cover, and is available with filters. Capacities range from 300 to 26,000 cfm (510 to 44,174 m³/hr) and 4 in. wg (995 Pa).

Catalog: *Tubular Centrifugal Fans — TCB/TCBRU/TCBRS*



Model TCBRU

Model TCBRU is a belt drive upblast roof exhaust fan. It features a tapered outlet which creates high outlet velocities to carry contaminated exhaust away from nearby make-up air units. Capacities range from 500 to 26,000 cfm (850 to 44,174 m³/hr) and 4 in. wg (995 Pa).

Catalog: *Tubular Centrifugal Fans — TCB/TCBRU/TCBRS*



Mixed Flow Fans

Mixed flow inline fans can be used for a wide variety of commercial, institutional and industrial applications handling everything from clean, grease laden or high-temperature air for supply, exhaust, or return air. Greenheck's unique wheel design excels in applications where low sound is critical. In addition, Greenheck's mixed flow fans are more efficient than comparably sized square inline and tubular centrifugal and vane axial fans, reducing the required motor horsepower and lowering operating costs.

Model SQ

Model SQ is a direct drive square inline mixed flow fan featuring a unique combination of high efficiency, low sound and ease of installation. Fans are ideal for supply, exhaust, return, or make-up air systems in indoor and outdoor clean air applications where space is a prime consideration. The Vari-Green® high-efficiency motor and a variety of accessories are available for customizing. Capacities up to 27,800 cfm (47,233 m³/hr) and 3 in. wg (747 Pa). AMCA Licensed for FEI, Sound and Air Performance.



Models QEI/QEID

Models QEI/QEID are mixed flow fans that deliver efficient and quiet performance. Universal mounting allows changing orientation in the field and standard integral airflow straightening vanes improve performance. Multiple series of construction tailor the unit to the application requirements. Typical applications include ventilation of office buildings, concert halls, parking garages, educational facilities, libraries, and dormitories. Capacities range from 700 to 116,000 cfm (1,190 to 197,085 m³/hr) and 10 in. wg (2,490 Pa). AMCA Licensed for Sound (inlet and outlet), Air Performance and FEI (Fan Energy Index). QEI model is OSHPD seismic certified.

Catalog: *Mixed Flow Fans — QEI (belt drive), QEID (direct drive)*



Model QEID FJ

Model QEID FJ Fume Jet is a direct drive tubular mixed flow inline fan ideal for exhausting lower volumes of light chemical or odor-laden air. The airstream pathway is constructed of corrosion-resistant, lightweight composite materials and includes a durable flanged casing for duct connections. The ventilated EC motor compartment protects the motor from the contaminated airstream to allow classification as a spark-resistant exhaust fan. Capacities range from 900 to 3,000 cfm (1,529 to 5,097 m³/hr) and 1 in. wg (248 Pa). Model QEID FJ is AMCA Licensed for FEI, Sound and Air Performance.

Catalog: *Mixed Flow Fans - QEI (belt drive), QEID (direct drive)*



Tube and Vane Axial Fans

Axial inline fans are designed for ducted indoor or outdoor applications. They are available in both direct drive and belt drive and with cast aluminum or fabricated steel propellers.

Inline or Roof Upblast: Models TDI/TBI-CA

Models TDI/TBI-CA axial fans feature a cast aluminum hub and airfoil blades. The universal mounting system allows for vertical or horizontal installations. Typical applications include clean air, fume exhaust, and spark-resistant construction. Capacities range from 1,300 to 95,000 cfm (2,209 to 161,406 m³/hr) and 3.5 in. wg (871 Pa). AMCA Licensed for FEI and Air Performance.

Catalogs: *Tube Axial Inline Fans — TDI and TBI-CA Level 3*
Medium Pressure Axial Fans — TBI-CA Level 4 & 5



Inline or Roof Upblast: Model TBI-FS

Model TBI-FS has a fabricated steel hub and airfoil blades. It is suitable for continuous high temperature (400°F/204°C max.) for inline configurations, (500°F/260°C max.) for roof upblast configuration and is available with UL Power Ventilators for Smoke Control Systems. The universal mounting system accommodates any vertical or horizontal installation configuration. Typical applications involve clean air, industrial processes, and high-temperature exhaust. Capacities range from 6,000 to 77,000 cfm (10,194 to 130,824 m³/hr) for inline configurations and 6,000 to 76,000 cfm (10,194 to 129,125 m³/hr) for roof upblast configurations and 4.5 in. wg (1,120 Pa). Bolt-on straightening vanes are available for increased efficiency. AMCA Licensed for FEI, Sound and Air Performance.

Catalog: *Medium Pressure Axial Fans — TBI-FS Levels 3, 4 & 5*



Inline or Roof Upblast: Model AX

Model AX features a cast aluminum hub and airfoil blades which have a manually adjustable blade pitch. The universal mounting system allows for vertical or horizontal installations. Typical applications include clean air and are available with UL Power Ventilators for Smoke Control Systems and UL 705. Bolt-on straightening vanes (AX-V) are available for increased efficiency. Capacities range from 500 to 125,000 cfm (849 to 212,376 m³/hr) and 5 in. wg (1,244 Pa). AMCA Licensed for FEI and Air Performance.

Catalog: *High Performance Axial Fans — AX*



Model VAB

Model VAB belt drive vane axial fans accommodate for final system balancing and have a manually adjustable blade pitch. These fans are an excellent choice for variable air volume HVAC systems, clean rooms, parking garage exhaust, and tunnel ventilation. For sound critical applications, belt drive vane axial fans are available with Greenheck's sound trap housing. UL/cUL 705 for electrical is available. A complete vibration test on all fans is performed prior to shipment. Capacities range from 2,000 to 145,000 cfm (3,398 to 246,357 m³/hr) and 7.5 in. wg (1,866 Pa). AMCA Licensed for FEI and Air Performance.

Catalog: *Vane Axial Fans — VAB and VAD*



Sound Trap Housing for Models VAB & VAD

Sound trap housings effectively decrease inlet and outlet sound power levels while only slightly increasing fan length and adding no additional pressure drop to the system.

Catalog: *Vane Axial Fans — VAB and VAD*



Model VAD

Model VAD is a direct drive vane axial fan designed for commercial and industrial applications where large volumes of air are required at moderate to high pressures. Direct drive vane axial fans have a manually adjustable blade pitch and require minimal maintenance. These fans are an excellent choice for variable air volume HVAC systems, clean rooms, parking garage exhaust, and tunnel ventilation. For sound critical applications, direct drive vane axial fans are available with Greenheck's sound trap housing. UL/cUL 705 for electrical is available. A complete vibration test on all fans is performed prior to shipment. Capacities range from 1,200 to 240,000 cfm (2,039 to 407,763 m³/hr) and 10 in. wg (2,488 Pa). AMCA Licensed for FEI and Air Performance.

Catalog: *Vane Axial Fans — VAB and VAD*



GreenJet® Fans

Vehicles in an underground parking structure or in maintenance facilities emit carbon monoxide (CO) and other noxious fumes into the atmosphere. There is a need for an efficient ventilation system to remove these toxins, circulate fresh air, and assist firefighters in the case of a fire emergency. The GreenJet® series includes a range of performances ideal for parking garage ventilation. Ductless designs use jet fans to dilute and remove contaminants and control smoke. The fans move air toward the exhaust area when installed on the ceiling.

Model GJI

The GJI model, with centrifugal wheel, maximizes the clearance height for vehicles or installations when space and driving clearance is limited. With the lowest GreenJet profile of under 12 inches (305 mm), it easily fits in tight spaces, helping keep clean air in hard-to-ventilate as well as open areas. The GJI utilizes an electronically commutated (EC) motor and a 0-10 VDC or MODBUS signal for speed and volume control. Capacities of 6 lb force of thrust (25N).

Catalog: *Jet Fans Model GJI*



Model GJX

GJX GreenJet fans are used with inlet and outlet silencers, inlet guards, mounting bracket and aluminum die-cast propellers and blades. The GJX features a true airfoil design propeller to move large volumes of air at a high efficiency using a smaller diameter fan. AMCA Licensed for Air Performance (AMCA 210). ULcUL Listed for Electrical (UL/cUL-705) and Power Ventilators for Smoke Control. Capacities of 4-17 lb force of thrust (18-75N).

Catalog: *Jet Fans Model GJX*



Circulators & Mancooler Fans

Air circulators and mancooler fans are designed for applications where localized air direction and circulation are required. Mounting arrangements offer maximum directional flexibility and ease of mounting.

Models IC/ICO

Models IC/ICO (non-oscillating/oscillating) two-speed air circulators are designed for spot cooling and recirculating air in factories, warehouses, manufacturing facilities and garages. Mounting options include wall, post or ceiling bracket, suspension bracket, I-beam mount and pedestal with optional wheel kit. Capacities range from 3,055 to 9,704 cfm (5,190 to 16,487 m³/hr) of free air. UL Listed Standard 507.

Catalog: *Industrial Air Circulators — IC/ICO*



Model MAC

Model MAC is a two-speed mancooler suitable for moving high volumes of directed airflow in factories, warehouses and agricultural applications. Fans are direct or belt driven with multiple mounting kits including mobile wheel, mobile tiltable carriage, suspension mount, ceiling mount and wall mount. Capacities range from 2,400 to 21,000 cfm (4,078 to 35,679 m³/hr) at free air. UL/cUL Listed Standard 507.

Catalog: *Mobile Air Circulators — MAC*



High Volume Low Speed (HVLS) Fans



AMPLIFY™ overhead fans provide airflow for effective air circulation and enhanced comfort in commercial and industrial spaces. With a variety of benefits including personnel cooling, humidity control, and heat distribution, these fans are an ideal selection for many applications.

AMPLIFY™ DC-5

Model DC-5 is a five-blade, direct drive HVLS fan designed for commercial spaces with low to medium ceilings. With its sleek design the DC-5 combines comfortable air movement with a variety of unique color options. These fans are effortless to install with the lightest total hanging weight among comparable HVLS fans. Fan diameters between 4.3 and 14 ft. Up to 55,000 cfm, UL/cUL 507, Energy Star Certified (4.3 – 7 ft.), and AMCA Licensed for Circulating Fan Performance (8 – 14 ft.).

Catalog: High Volume, Low Speed Fans - DC and DS



AMPLIFY™ DS-3

Model DS-3 is a three-blade, direct drive HVLS fan designed for commercial or industrial spaces with medium to high ceilings. These economical fans are the ideal balance between cost and performance, making them a smart choice for budget-conscious building owners. Plus, with a lighter weight than comparable HVLS fans, the DS-3 is a breeze to install in any building. Fan diameters between 8 and 24 ft. Up to 176,900 cfm, UL/cUL 507 and AMCA Licensed for Circulating Fan Performance.

Catalog: High Volume, Low Speed Fans - DC and DS



AMPLIFY™ DS-6

Model DS-6 is a six-blade, direct drive HVLS fan designed for commercial or industrial spaces with medium to high ceilings. As the industry's best performing HVLS fan, the DS-6 delivers unrivaled airflow at incredibly quiet sound levels. Along with reduced operating costs, the DS-6 is clearly the best value HVLS product on the market. Fan diameters between 8 and 24 ft. Up to 243,000 cfm, UL/cUL 507 and AMCA Licensed for Circulating Fan Performance.

Catalog: High Volume, Low Speed Fans - DC and DS



AMPLIFY™ with Northern Light® DC-5

AMPLIFY overhead fans with Northern Light® technology combine engineered air movement with the air cleaning benefit of upper-room UV-C lighting making it the right selection for inactivating airborne pathogens. UV-C has been used for decades and the addition of air movement has been shown to increase UV-C's effectiveness in inactivating airborne pathogens in building environments. Fan diameters include 9.8, 13.1 and 16.4 ft. Up to 44,000 cfm.



AMPLIFY™ Controls

Maintain easy operation of HVLS fans by using optional controls to maximize efficiency. Designed for convenience and versatility, all HVLS controls run one or multiple HVLS fans with common communication protocols, and are available with surface or recessed mounting kits.

- Keypad
- Standard touchscreen
- Advanced touchscreen with BACnet®
- Bluetooth Tablet (Northern Light® only)



Sidewall Exhaust, Supply and Reversible Fans



Propeller fans include both direct and belt-driven fans with fabricated steel, aluminum, or cast aluminum blades. These fans are suitable for clean air applications, including exhaust, supply, filtered supply, and reversible. Typical applications are factories and warehouses.

Models AER/S1/S2/SB/SBC

Sidewall propeller fans are available with a wide variety of accessories including wall housings, wall collars, guards, dampers, and weatherhoods. The Vari-Green® EC motor is available on model AER and SE direct-drive fans. Capacities range from 115 to 87,000 cfm (195 to 147,814 m³/hr) and 2.45 in. wg (610 Pa). AMCA Licensed for Sound and Air Performance. OSHPD seismic certified.

*Catalog: Sidewall Propeller Fans — Exhaust, Supply and Reversible
Wall Exhaust and Supply Fans — AER*



Models SCR3/SBCR

Reversible sidewall fans offer the ability to exhaust or supply air on demand. Performance is equivalent in both the exhaust and supply modes. Capacities range from 2,900 to 70,500 cfm (4,927 to 119,780 m³/hr) and 0.5 in. wg (124 Pa). OSHPD seismic certified.

Catalog: Sidewall Propeller Fans — Exhaust, Supply and Reversible



Model SDPHE

Model SDPHE fans are direct drive type, suitable for ventilating spaces containing flammable or explosive vapors, gases or dusts. For use with NEC Class I, Division I, Groups C and D; NEC Class II, Division I, Groups F and G. Performance capabilities range from 604 to 6,317 cfm (1,026 to 10,733 m³/hr) and up to 0.5 in. wg (124 Pa). UL/cUL Listed Standard 1203.



Model CBF

Model CBF is designed for economy and reliability in limited space applications. Fits in lieu of standard 16-inch by 8-inch concrete block and is mountable in any wall construction. Works well for ventilating equipment rooms and chases. Capacities range from 300 to 500 cfm (510 to 850 m³/hr) and 0.4 in. wg (99 Pa).

Catalog: Transfer Fan — CBF



Vari-Green® and Greenheck Motor Starters



Greenheck's Vari-Green® products are designed for energy-efficiency, controllability and low maintenance. They are an environmentally progressive option when specifying products for your next project. Greenheck's motor starters are available for both single phase and three phase motors in commercial and industrial applications. They include motor protection as well as the ability to provide controllability. All Greenheck motor starters are available in either indoor or outdoor enclosures.

Vari-Green® Motor

The Greenheck Vari-Green motor is an electrically commutated (EC) motor that operates on single or three phase AC power input and internally converts it to DC power providing better speed control capabilities (up to an 80% turndown) and higher efficiencies (85% efficient at all speeds) than standard motors. The Vari-Green motor blends technology, controllability and energy efficiency in a low maintenance package that is changing the way the industry designs, specifies and operates air movement equipment. Depending on horsepower, Vari-Green motors are available in both single and three phase with a variety of sizes currently available on models AER, RDU, RE/RS, RCE/RCS, SP, CSP, G, CUE, SQ, USF, SE1, and SS1 with either a dial mounted potentiometer (speed control) on the motor or it can accept a 0-10 VDC control signal from an external source.



Vari-Green® Controls

Greenheck's Vari-Green Controls are designed specifically for the Vari-Green motors. Vari-Green controls are available for applications requiring manual operation or demand controlled ventilation (DCV). Applications utilizing DCV controls provide only the desired amount of ventilation, providing building owners savings on their energy bills. Vari-Green Controls available are:

- Manual Controls
 - Remote Dial
 - Touch Remote
- Demand Controlled Ventilation
 - Two-Speed Control
 - Constant Pressure (indoor or outdoor)
- Hand/Off/Auto (HOA)
- Air Quality - Volatile Organic Compound (VOC)
- Air Quality - Temperature/Humidity

Vari-Green® Drive

The Vari-Green Drive (VGD) is a factory-mounted and wired, programmed, variable speed control for motors up to 10 hp. This drive expands the Vari-Green concept of variable speed fans to more models and sizes to fit the expanding ventilation and efficiency needs of the industry. The Vari-Green Drive is available on the AER, CUE, CUBE, G, GB, SCE3, SCS3, SE2 and SS2 models.



Greenheck Motor Starters

Models MSAC, MSSC and MS-1P, MSEM and MSTs provide a wide range of control logic solutions as well as electronic overload protection for the motor. The MSAC and MSSC are three-phase controllers that can be used on any single speed, nonreversible fan with a motor between ¼ hp and 25 hp (1-40 amps). They are capable of integrating with other building controls such as building management systems and thermostats. The MSAC has additional advanced control integration that includes emergency shutdown, fireman's override, damper actuator voltage, end switch monitoring and status output. The MS-1P is a single phase controller that will work on any fan with a single phase motor up to 1 hp (1-16 amps). It also has two control inputs and two status outputs—run and fault.



Utility, Centrifugal and Radial Blowers



Greenheck offers a complete line of heavy-duty centrifugal fans and radial blowers for any commercial and industrial application. Greenheck centrifugal products are used for everyday commercial applications such as providing supply, exhaust, and return air in hospitals, schools, and large office buildings or fume exhaust for laboratories and pharmaceuticals. These products are also well suited for industrial applications involving high-temperature process exhaust, filtration systems, corrosive air exhaust, and material handling.

Utility Centrifugal Fans

The utility fans include both direct and belt-driven fans. They are self-contained units consisting of the fan, motor, and drive for a variety of commercial and light industrial applications.

Model USF

Model USF operates in a broad range of fan applications, typically in ducted systems for exhaust, supply or return air. Versatile construction options allow use in general applications or environments which require spark resistance, high temperature tolerance or resistance to corrosive elements.

Capacities range from 200 to 150,000 cfm (340 to 254,851 m³/hr) and up to 21 in. wg (5,226 Pa).

Options:

- Belt or direct drive configurations
- Vari-Green® EC motors and drives
- Spark-resistant construction
- UL 705 Power Ventilators Listing
- UL 762 Grease Listing
- UL Power Ventilators for Smoke Control Systems Listing

Certifications:

- AMCA Licensed for FEI, Sound and Air Performance
- OSHPD seismic certified
- Florida Product Approval and Miami-Dade NOA high wind certification

Catalog: *Centrifugal Fans Model USF*



Double Width - Models BIDW/AFDW

Models BIDW/AFDW operate in non-ducted inlet applications, primarily handling clean air below 200°F. Higher volume capacities allow for a more compact system design than with single-width fans. Air handling quality bearings with L10 life in excess of 80,000 hours (equivalent to an average life of 400,000 hours). Each fan is three-plane vibration tested prior to shipment. OPTIONS: UL 705 Power Ventilators Listing. Capacities range from 1,500 to 379,000 cfm (2,549 to 643,925 m³/hr) and 15 in. wg (3,733 Pa). AMCA Licensed for FEI, Sound and Air Performance.

Catalog: *Centrifugal Fans — Models BIDW and AFDW*
Double-Width Centrifugal Fan Performance Supplement



Fiberglass Reinforced Plastic (FRP) Fans

FRP fans are designed for exhausting corrosive air in a variety of applications. Typical applications include wastewater treatment odor control, pollution control scrubbers, and other highly corrosive airstreams. Each FRP fan is constructed using hand lay-up or chop spray manufacturing techniques and every FRP component complies with ASTM specifications C582 and 4167 for fiberglass laminates and pressure blowers. All FRP fans use air handling quality bearings and are AMCA Spark A resistant.

Model BCSW-FRP

Model BCSW-FRP uses a backward-curved centrifugal wheel and comes in both direct and belt drive models. The BCSW-FRP is constructed to exceed the industry standard for vibration with 0.078 in./sec velocity for the belt drive. For light duty, clean air to 170,000 cfm, 16 in. wg (2,488 Pa). AMCA Licensed for FEI and Air Performance.

Catalog: *Fiberglass Centrifugal Fans – BCSW-FRP*



Fabricated Pressure Blowers

Fabricated pressure blowers are suitable for air exhaust or supply applications. Typical applications include cabinet or room pressurization, blow-off systems for moisture removal, combustion air for burners, parts cooling, and fume exhaust.

Model FPB

Model FPB fabricated pressure blowers utilize radial aluminum blade wheels to provide peak performance for systems that require low flow and high pressures. FPB pressure blowers are designed with a totally rotatable steel housing with a baked polyester coating. Capacities range from 200 to 2,500 cfm (340 to 4,248 m³/hr) and 9.5 in. wg (2,364 Pa).

Catalog: Pressure Blowers — FPB

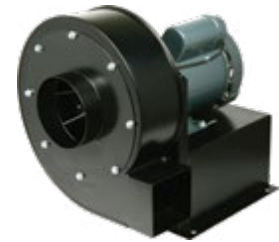

Industrial Process Fans

The industrial process fans menu includes fan types engineered and built for reliable operation in harsh environments where high temperatures, high static pressures, and material handling requirements are encountered.

Open Radial Material Handling Wheel can be utilized for most industrial requirements. Applications include: exhausting abrasive dust such as grinding and buffing wheel exhaust, conveying granular materials such as sawdust, wood chips, fume exhaust, and high temperature air handling.

Wool Type Material Handling Wheel is designed for handling long, fibrous, stringy material. Applications include: conveying long wood shavings, yarns, and paper trimmings. It can also be used for similar applications as the open wheel, but has higher efficiencies.

Industrial Air Handling Wheel is designed for clean air exhaust to slight material handling. Applications include: smoke and heat exhaust, corrosives, heavy fumes, and light dust loading. The air handling wheel is the most efficient in the industrial process fan series.

Capacities range from 200 to 143,000 cfm (340 to 242,959 m³/hr) and 32 in. wg (7,970 Pa). AMCA Licensed for FEI and Air Performance.

Catalog: Industrial Process Fans



Plug Fans

Plug fans are designed and built to provide reliable service in industrial applications where the fan operates unhooused within a pressurized plenum.

Model PLG

Model PLG unhooused plug fans feature compact unit sizes and a high efficiency backward-inclined wheel which makes them ideal selections for HVAC installations, spray booths, air curtains and high temperature applications including ovens, dryers, and kilns. Capacities range from 900 to 71,000 cfm (1,529 to 120,630 m³/hr) and 8 in. wg (1,991 Pa), and maximum temperature of 800°F (426°C).

Catalog: *Plug Fans — PLG*



Plenum Fans

Plenum fans are designed for air handling applications where the fan operates unhooused within a pressurized plenum. Plenum fans are designed to be compact in size, have the flexibility to supply multiple air take-offs and are economically priced.

Model OPA

The OPA is a configurable open plenum array designed and optimized for a specified height and width. Each design point will offer multiple solutions allowing for selections based on the most important criteria such as sound, HP, number of fans or overall efficiency. Construction of the OPA is foam filled galvanized steel panels with laser cut and formed galvanized steel structure. The array is fully assembled and factory tested. The OPA can be designed with NEMA premium AC induction motors up to 10 hp or three-phase Vari-Green® motors with integrated drives providing industry-leading IE5 efficiencies. Aluminum wheel construction is standard on all selections with optional airfoil construction available.



Model APD

The APD is a commercial grade plenum fan that incorporates performance and reliability into a lighter duty, economical design. The compact direct drive APD eliminates the cost, maintenance and complexity of traditional belt drive plenum fans. APD is constructed from a formed and bolted galvanized steel frame with a welded and coated steel seven-bladed, backward-curved wheel. Capacities range from 1,000 to 18,000 cfm (1,699 to 30,582 m³/hr) and 10 in wg. (2,488 Pa)



Model APM – Light to Medium Duty Plenum Fan

Designed for light and medium duty applications, this model has a galvanized framework at a more cost-effective price point. Efficient operation and lower overall sound with a 12-bladed aluminum airfoil wheel. Units are available in belt and direct drive with a simplified selection of accessories. Capacities range from 1,000 to 41,000 cfm (1,699 to 69,659 m³/hr) and 8 in. wg (1,991 Pa).

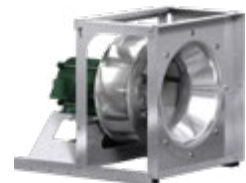

Model APH – Medium to Heavy Duty Plenum Fan

Designed and engineered for medium and heavier duty applications with a fully welded and painted steel configuration. Efficient operation and lower overall sound with a 12-bladed aluminum airfoil wheel. This plenum is available in both belt and direct drive and offers numerous accessories to complement your project. Capacities range from 1,000 to 209,000 cfm (1,699 to 355,093 m³/hr) and 12.5 in. wg (3,111 Pa).



Model HPA

Model HPA hooused plenum fans provide high efficiency while maintaining a compact size and low sound power levels. Utilizing a galvanized framework with integral isolation, the HPA uses a high efficiency, low sound 12-blade wheel with a sound attenuating housing to further reduce sound power levels. HPA fans can be easily stacked together in parallel as a fan array offering 100% redundancy. Capacities range from 900 to 45,000 cfm (1,529 to 76,455 m³/hr) and 7 in. wg (1,742 Pa).

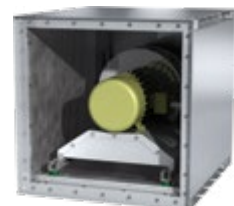

Catalog: *Plenum Fans — APD, APM, APH and HPA*

Fume Exhaust Systems



Greenheck's fume exhaust systems are designed to safely handle fumes and odors in commercial, industrial and life safety laboratory applications. All systems are pre-engineered to meet application guidelines provided by ANSI, NFPA, and ASHRAE.

Features include guy wire-free discharge stacks to prevent exhaust re-entrainment, spark resistant construction, corrosive resistance coatings, and AMCA Licensed performance data. They can additionally be configured for specialized applications such as high temperature exhaust.

FumeJet® Commercial and Industrial

Greenheck's FumeJet family is a pre-engineered exhaust system that safely removes and disperses contaminated air. Factory supplied and tested combination of a centrifugal blower with a discharge stack provides a quick and easy alternative to a field built-up system. Designed to follow ANSI Z9.2 standard for local exhaust systems, tested to withstand a force of 34 psf without the need for guy wires (equivalent force to 115 mph (185 km/h) wind speed).

Model FJC

Model FJC is a lower cost commercial fume exhaust fan for low volume and low pressure applications. Belt driven, it is available in two materials, either galvanized or chemical resistant coated steel, for environments requiring increased coating protection. Fan has bolted frame construction and Permalock™ sealed scroll. Capacities range from 200 to 5,000 cfm (340 to 8,495 m³/hr) and 4.5 in. wg (1,120 Pa). FJC is UL/cUL 705 Power Ventilators Listed. AMCA Licensed for FEI and Air Performance (sizes 6-10); AMCA Licensed for FEI, Sound and Air Performance (sizes 12-24). OSHPD seismic certified.

Model FJI

Model FJI is an industrial fume fan with higher performance capabilities and additional options for AMCA Spark B or high temperature construction as well as belt or direct drive. Coated steel scrolls are Permalock™ sealed or continuously welded. Airflow capacities range from 200 to 18,000 cfm (340 to 30,582 m³/hr) and 9 in. wg (2,240 Pa). FJI is available with UL/cUL 705 Power Ventilators Listed. AMCA Licensed for FEI, Sound and Air Performance.

Catalog for above models: *FumeJet Exhaust Systems*

Discharge Options



Straight Stack
Clean design with uniform straight discharge stack. Most economical discharge option.



No-Loss Stack
Extended overlapping discharge stack reducing the amount of rain entering into fan housing.



Fixed Nozzle
Tapered nozzle discharge increases outlet velocity sending exhaust fumes higher above the roof deck area. Does not negatively impact fan performance.



Adjustable Nozzle
Allows the user to adjust the discharge area based on installed conditions. Four blade positions available.

Laboratory Exhaust Systems



Greenheck has the most extensive line of laboratory exhaust systems in the industry. The main objective of a laboratory exhaust system is to remove hazardous or noxious fumes from a laboratory, dilute the fumes as much as possible and expel them from the laboratory building preventing contamination of the roof areas and re-entrainment into building make-up air systems.

All Vektor® blowers and bypass air plenums are constructed of heavy-gauge welded steel and coated with LabCoat™, a two-part corrosion-resistant zinc-rich coating. Systems are designed to a code compliant minimum discharge height of 10 feet (3m) and able to withstand 125 mph (200 km/h) windloads without the use of guy wires. Good for constant or variable volume exhaust applications.

High Plume Discharge

The high plume discharge nozzle is an engineered, tapered outlet nozzle designed to accelerate laboratory exhaust to maximize the effective plume height. Multiple discharge nozzles per fan size are available to custom-tailor discharge velocity and plume rise.



Vektor®-H

Model Vektor-H is a cost efficient product designed for lower volume, lower pressure applications. Vektor-H uses an inline centrifugal wheel built to AMCA Spark B construction. Capacities range from 500 to 26,000 cfm (850 to 44,174 m³/hr) and 4 in. wg (995 Pa). Belts, bearings and drives are fully sealed from the contaminated airstream. The direct drive inlet cone, wheel and motor are combined in a single assembly for easy removal. Inspection door provided to view and inspect wheel. Belt drive model is NOA approved, UL 705 Power Ventilators Listed, and UL 762 Listed Power Ventilator for Restaurant Exhaust Appliances. AMCA Licensed for FEI, Sound and Air Performance.

Catalog: *Laboratory Exhaust Systems — Vektor-H*



Vektor®-MH

Model Vektor-MH uses an inline mixed flow fan to quietly and efficiently exhaust fumes and odors above a laboratory. This is a low cost application for projects with moderate levels of exhaust and static pressure. Benefits include efficient operation for reduced energy consumption and lower overall sound levels. The Vektor-MH increases safety for maintenance and service by utilizing a bifurcated housing that separates the exhaust airstream around drive components. Vektor-MH is available with AMCA Spark B or C construction. Airflow capacities range from 2,000 to 47,000 cfm (3,398 to 79,854 m³/hr) and 11 in. wg (2,737 Pa). Model is UL 705 Listed for Power Ventilators. AMCA Licensed for FEI, Sound and Air Performance.

Catalog: *Laboratory Exhaust Systems — Vektor-MH and Vektor-MD*



Vektor®-CH

The Greenheck Vektor-CH is a high plume laboratory exhaust system. Vektor-CH utilizes a centrifugal blower to achieve high pressures and flow rates commonly required by filtration systems. Systems are available as single fan with or without bypass air plenum or multiple fan systems with common plenum. Belt and direct drive configurations. Eleven model sizes with a per fan performance range 1,000 to 56,000 cfm (1,699 to 95,145 m³/hr) and up to 12 in. wg (2,986 Pa). OSHPD seismic certified. AMCA licensed for FEI, Sound and Air Performance.

Catalog: Laboratory Exhaust Systems — Vektor-CH and Vektor-CD



High Plume with Constant Velocity Discharge

Utilizing Greenheck's Variable Geometry Nozzle (VGN) technology, a constant duct static pressure is maintained by adjusting the fan speed with a variable frequency drive. As airflow through the fan varies, the nozzle discharge area automatically changes to maintain a constant and safe discharge stack velocity regardless of the laboratory exhaust flow. End-users will enjoy benefits such as demand-based laboratory ventilation, reduced fan energy consumption, and reduced operating costs.



Vektor®-HS

Model Vektor-HS combines the VGN and controls with a base model providing advanced system operation for lower costs. The Vektor-HS uses an inline centrifugal wheel with AMCA Spark B construction. Vektor-HS bypass air plenums are designed to support single or multiple Vektor-HS inline exhaust blowers. Airflow capacities range from 1,000 to 26,000 cfm (1,699 to 44,174 m³/hr) and 3.5 in. wg (871 Pa). Model is UL 705 Listed for Power Ventilators. AMCA Licensed for Air Performance.

Catalog: Laboratory Exhaust Systems — Vektor-HS, Vektor-MS and Vektor-CS



Vektor®-MS

Model Vektor-MS with increased performance range offers higher building turndowns and more available cost savings. The mixed flow wheel provides higher performance ranges at higher efficiencies and reduced sound levels. The Vektor-MS models incorporate a bifurcated housing for increased personnel safety. Airflow capacities range from 2,000 to 32,000 cfm (3,400 to 54,368 m³/hr) and 10 in. wg (2,488 Pa). Model is UL 705 Listed for Power Ventilators. AMCA Licensed for Sound and Air Performance.

Catalog: Laboratory Exhaust Systems — Vektor-HS, Vektor-MS and Vektor-CS



Vektor®-CS

Model Vektor-CS is a high plume laboratory exhaust system with an energy saving variable geometry nozzle to maintain a constant discharge velocity. The Vector-CS features an efficient centrifugal airfoil wheel design, air handling quality bearings and is in compliance with ANSI and NFPA standards for laboratory exhaust applications. Belt and direct drive configurations. Eleven model sizes with airflow capacities ranging from 1,500 to 32,000 cfm (2,549 to 54,368 m³/hr) and up to 10 in. wg (2,488 Pa). OSHPD seismic certified.

Catalog: Laboratory Exhaust Systems — Vektor-HS, Vektor-MS and Vektor-CS



High Plume with Dilution

The high plume nozzle with dilution entrains additional air for a less concentrated exhaust. High plume nozzles and the dilution windband entrain ambient air to assist in the dilution of the laboratory exhaust and to maximize the plume rise. This nozzle and windband combination is especially effective with high demand levels of exhaust at moderate to high external static pressures.



Vektor®-MD

Model Vektor-MD brings together higher dilution with the high efficiency mixed flow wheel and bifurcated housing. The benefits include an inline style fan mounted on top of the bypass air plenum for increased effect plume heights and reduced footprint requirements. Vektor-MD units available in AMCA Spark B or C construction. Airflow capacities range from 1,500 to 83,000 cfm (2,549 to 141,018 m³/hr) and 11.5 in. wg (2,862 Pa). Model is UL 705 Listed for Power Ventilators. AMCA Licensed for Sound, Air and Induced Air Performance.

Catalog: *Laboratory Exhaust Systems — Vektor-MH and Vektor-MD*



Vektor®-CD

Model Vektor-CD utilizes a backward inclined, flat blade or airfoil blade centrifugal wheel with efficient scroll housing. Vektor-CD units are available in AMCA Spark B or C construction. Airflow capacities range from 1,500 to 122,000 cfm (2,548 to 207,279 m³/hr) and 13.5 in. wg (3,359 Pa). Model is UL 705 Listed for Power Ventilators. AMCA Licensed for Sound, Air and Induced Air Performance.

Catalog: *Laboratory Exhaust Systems — Vektor-CH and Vektor-CD*



Energy Recovery Systems

Models Vektor-M and C Series can be integrated for use with an energy recovery plenum to reduce the operating cost of your laboratory. Greenheck Vektor energy recovery systems utilize glycol filled, runaround coil loops to safely transfer energy between the laboratories' exhaust and supply airstreams. These sensible only heat transfer systems allow the supply and exhaust duct systems to be separated safely and prevent the possibility of cross contamination.

The energy recovery system utilizes a cost saving pre-engineered plenum with capabilities to handle a range from 2,000 to 66,000 cfm (3,400 to 112,200 m³/hr) and external static pressure up to 8 in. wg (2,000 Pa). This system offers single source responsibility while providing up to 55% efficiency of energy recovery.

The plenum is manufactured with an insulated double-wall exterior design, a steel interior and comes complete with corrosion resistant coated energy recovery coils. Systems can be manufactured for constant or variable volume systems as well as options for multiple blower configurations when redundancy is required.

Catalog: *Energy Recovery Laboratory Exhaust Model Vektor-ERS For Vektor-C and Vektor-M Series*

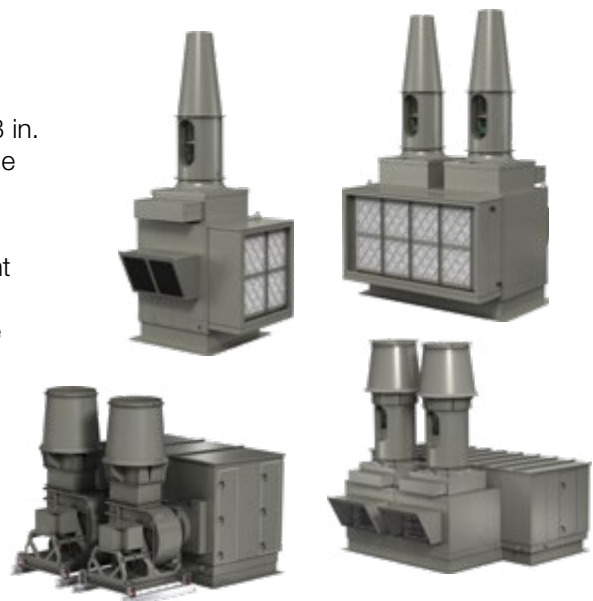

Kitchen Ventilation Systems





Greenheck offers a wide selection of top quality kitchen hoods, exhaust fans, make-up air units, variable volume control systems, fire suppression systems and utility distribution systems. These systems can be designed by using our Computer Aided Product Selection CAPS® program. This program enables you to select and configure products as well as view real-time drawings and create AutoCAD® files instantly.

*For detailed information and application of these products visit www.greenheck.com. For personalized training and a live kitchen demonstration, talk with your local Greenheck representative to schedule a visit to Greenheck in Schofield, WI.

Type I Kitchen Hoods

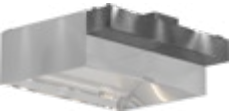
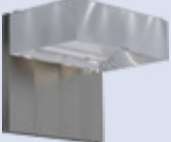
Designed for grease-laden air. Kitchen hoods are available in canopy and proximity (backshelf) styles. Canopy hoods are available as exhaust only with external supply plenum options. All hoods are UL/cUL 710 Listed and available in single-section lengths from 4 to 16 feet. Longer hoods are available in multiple sections with our continuous capture option. Available canopy hood configurations: wall, island, double-island, self-cleaning, and V-bank. Standard construction is stainless steel where exposed and galvanized steel in the unexposed plenum. 100% stainless steel construction is available. Either option is available in 300 series or 430 stainless steel.

Exhaust Only Hood with External Supply Plenum Options	Recommended Application
 <p style="text-align: center;">ASP Air Curtain Supply 10 to 24-inches</p>	<p>Non-Tempered/Heat Only; To minimize mixing with air in the space by distributing airflow at the hood, downward.</p>
 <p style="text-align: center;">BSP Back Supply</p>	<p>Non-Tempered or Marginally Tempered Air; Air is kept near hood to minimize mixing with air in the space.</p>
 <p style="text-align: center;">Split ASP Split Air Curtain Supply</p>	<p>All Conditions; Minimize mixing with air in the space by distributing airflow at the hood, downward.</p>

Proximity Hoods

Typically used in quick service restaurants or low ceiling applications, the hood is hung in close proximity to the cooking surface. Greenheck hoods have several dimensions of flexibility to meet various application requirements. Hoods are offered in lengths from 3 to 16 feet, heights from 24 to 36 inches and are compatible with all filter options. The optional flue bypass directs hot flue gasses behind the filter bank with the benefit of reducing radiant heat load in the space and preventing baking grease onto the filters.



Auto Scrubber™

The Auto Scrubber can be used with any of our filters and provides superior cleaning of the inside of the exhaust plenum and the filters. Filter and fire system components are easily inspected and serviced via toolless access panels located within the hood. Large two-inch drains capture grease with ease. The Auto Scrubber can connect to a building automation system which is compatible with our Kitchen Fan Control Center (KFCC), Vari-Flow and Melink® control systems.



Residential Range Hood

Greenheck's Fire Ready hood operates both as a functional ventilation hood and a fire suppression system. Fan and lights are controlled from the face of the hood or from an optional handicap accessible remote panel.



Filtration Options

Greenheck has the most efficient mechanical grease filters in the industry. All of our grease filters are UL/cUL 1046 Classified and NSF Certified. Efficiency ratings were obtained by testing to the ASTM F2519-2005 test standard.

Grease Grabber™

High-efficiency dual-filtration system (*100% efficient, Greenheck patented and manufactured filter). Grease-X-Tractor is the primary filter.

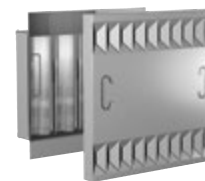

Grease Grabber



Grease-X-Tractor

Grease-X-Tractor™

High-efficiency centrifugal filter (*69% efficient, Greenheck patented and manufactured filter).

Baffle Filter

Standard industry baffle (*28% efficient, purchased filter).



Baffle

**Filter efficiencies measured at 8 microns.*

Type II Kitchen Hoods

Designed for non-grease applications. Nonfiltered heat and condensate hoods.

Heat and Fume Hoods

Model GO

Primarily used for oven applications. Can be used for other heat and fume removal applications. No gutter or drain. Lighting options available.

Condensate Hoods

Available with a gutter and drain connection.

Model GD1

No baffles. Most economical and flexible. Lighting options available.

Model GD2

One baffle. Designed for moderate condensation applications. Great for vertical door dishwasher applications. Lighting options available.

Model GD3

Two baffles. Designed for heavy condensate applications.



Fire Suppression Systems

The first line of defense against fire in a commercial kitchen is the hood fire protection system. Greenheck has a variety of factory prepiped fire protection systems available.

Amerex® KP, Amerex® Zone Defense, Wet Chemical - ANSUL® R-102™, ANSUL® Overlapping Coverage

The Amerex KP and ANSUL R-102 Wet Chemical Fire Suppression System is an automatic, pre-engineered system designed to protect ventilating equipment including hoods, ducts, plenums, filters, and cooking equipment. Once activated, the system discharges a wet chemical through all nozzles simultaneously. Amerex Zone Defense and ANSUL Overlapping Coverage offers full flood fire protection that allows flexibility in equipment placement.

Catalog: Type I Hood Fire Suppression Systems



Dual Agent

The ANSUL® PIRANHA Restaurant Wet Agent Fire Suppression System is a dual-agent, pre-engineered fixed, automatic fire extinguishing system, designed to protect ventilating equipment including hoods, ducts, plenums, filters, and the cooking equipment. Once activated, the system discharges a wet chemical followed by water through all nozzles simultaneously.

Catalog: Type I Hood Fire Suppression Systems

Amerex® STRIKE

Amerex STRIKE is a kitchen fire suppression electronic control system, designed to work with Amerex's KP and KP Zone Defense fire suppression packages. Amerex STRIKE utilizes linear electronic detection, a safer and more effective solution to fire detection, while also simplifying installation and reducing maintenance.

Catalog: Type I Hood Fire Suppression Systems

Pollution Control Units

Specifically designed to eliminate grease particles and smoke while mitigating odor from your kitchen exhaust system.

Grease Trapper™, Grease Trapper ESP™

The Grease Trapper unit uses a four-stage mechanical filter arrangement to remove grease and smoke particles from the exhaust air. The Grease Trapper ESP uses electrostatic precipitator modules and carbon filters to remove grease, smoke and odors from the exhaust airstream. Both are UL 8782 listed to grease duct standards.

Catalog: *Pollution Control Units*

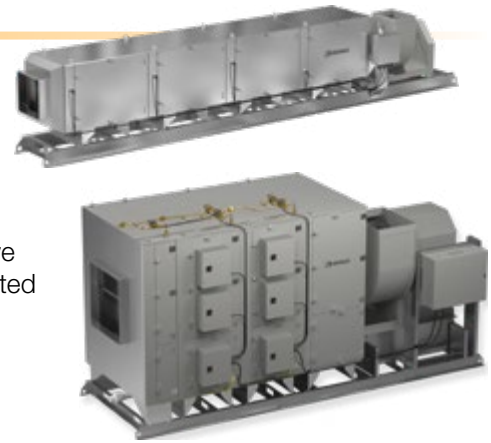

Kitchen Controls

Control your entire kitchen ventilation system with ease — from fans, make-up air and lighting to all components of a constant or variable volume ventilation system. The Greenheck controls platform provides increased value using high-quality products integrated seamlessly for a streamlined, efficient operation. Options such as a room thermostat allow you to customize your kitchen ventilation needs.

The interface can be programmed to allow you to see and control only functions you select without requiring you to go through a series of screens not applicable to your needs — a truly innovative solution, simplifying the control of your total kitchen ventilation system.

Catalog: *Kitchen Ventilation System Controls*



Utility Distribution Systems

FlexConnect™ utility distribution systems provide flexibility, convenience and safety in commercial cooking operations. Factory-built systems offer a cost-effective way to replace contractor-built utilities in walls. These systems provide a single point of connection for gas, electricity, water, and steam. Utility distribution systems are available in wall and island styles.

Flexible

FlexConnect™ Utility Distribution System (UDS) model M allows for future expansion or relocation of appliances without expensive modifications. Gas appliance drops are located every 12 inches, hot and cold water drops every 24 inches to allow for equipment line-up changes. Optional electrical service can be supplied as a point of use breaker, panel board, receptacle only configuration.

Convenient

Modules are available in incremental lengths, expandable to accommodate virtually any cooking line-up.

Fast

Installation requires only limited trade involvement to bring incoming utility services in for hook-up.

Catalog: *Utility Distribution System*



Energy Recovery Ventilators Preconditioners



With Greenheck, you get a comprehensive energy recovery line ranging from a 150 cfm inline preconditioner to a 12,000 cfm fully-tempered ventilator with stand-alone controls. Each unit provides fresh outdoor air to your system to meet ASHRAE 62.1 ventilation requirements, while recovering energy from the exhaust airstream with a total energy wheel or core to meet energy codes. The energy recovery technologies give your system the advantage of sensible and latent energy recovery which improves indoor humidity, maximizes energy savings, and provides lowest first-cost ventilation air for air conditioning (by reducing outdoor air load). Supplemental cooling and heating options provide you total control over outdoor air conditions entering your system.

Preconditioners

Greenheck offers a complete line of energy recovery ventilators to reduce your commercial or institutional building's tempering loads in all climates. From outdoor roof-mounted applications to indoor ceiling-mounted units, Greenheck's preconditioners offer the installation flexibility for both new construction and retrofit applications. These units package a total energy wheel or core with exhaust and supply blowers and factory prewired electrical components.

Model ERV: Interior or Exterior Installation

Model ERV provides a total enthalpy wheel with optional frost control, economizer control, variable frequency drives, stand-alone microprocessor, and BMS communication. Offers installation flexibility for both interior and exterior applications. Available in five sizes. Capacities range from 500 to 12,000 cfm (850 to 20,388 m³/hr) and 1.5 in. wg (372 Pa). ETL Listed.

Catalog: *Energy Recovery Ventilators - MiniVent, ERV, ERVe, MiniCore, ECV, and ERM*



Model ERVe: Exterior Installation

Model ERVe is specifically designed to handle conditions experienced in outdoor installations. The ERVe is a stand-alone unit for 100% outdoor air to be provided directly into the space or an air handler. Multiple wheel options provide functionality and flexibility. Capacities range from 2,000 to 6,000 cfm (3,398 to 10,194 m³/hr) and 1.5 in. wg (248 Pa). ETL Listed.

Catalog: *Energy Recovery Ventilators - MiniVent, ERV, ERVe, MiniCore, ECV, and ERM*



Model MiniVent: Interior Installation

Model MiniVent is an indoor energy recovery ventilator. The compact design provides an economical solution for individual spaces, such as classrooms and small offices. Pleated one-inch deep filters, duct flanges, backdraft dampers, and Vari-Green® EC motors are standard. Capacities range from 150 to 850 cfm (255 to 1,444 m³/hr) and 1 in. wg (248 Pa). ETL Listed.

*Catalog: Recovery Ventilators Preconditioners —
Models MiniVent, ERV, ERVe, MiniCore, ECV and ERM*



Model ECV: Interior or Exterior Installation

Model ECV utilizes an air-to-air total energy core manufactured out of a fiber or polymer membrane, designed for indoor or outdoor mounting for commercial and institutional applications. Model ECV-10 comes standard with direct drive, forward curved fans and Vari-Green® EC motors while models ECV-20, -30, and -40 come standard with direct drive, mixed flow plenum fans and VFDs. Optional controls and accessories include stand-alone microprocessor control, BMS communication, bypass damper for economizer and hinged access. Available in four sizes with capacities ranging from 500 to 5,000 cfm (850 to 8,495 m³/hr) and 1 in. wg (248 Pa). ETL Listed.

*Catalog: Recovery Ventilators Preconditioners —
Models MiniVent, ERV, ERVe, MiniCore, ECV and ERM*



Model MiniCore: Interior Installation

Model MiniCore utilizes a total energy, fiber membrane core, direct drive fans with Vari-Green® EC motors, and backdraft dampers. Designed for indoor installations, the MiniCore can be hung in any orientation and features configurable intake and discharge connections. Capacities range from 150 to 1,000 cfm (255 to 1,444 m³/hr) and 1 in. wg (248 Pa). ETL Listed.

*Catalog: Recovery Ventilators Preconditioners —
Models MiniVent, ERV, ERVe, MiniCore, ECV and ERM*



Energy Recovery Modules

Model ERM energy recovery modules offer the advantages of Greenheck’s energy recovery wheel for use in built-up ventilation systems. Modules are ideal for new construction or retrofit applications where a model ERV energy recovery ventilator may not meet space limitation requirements.

Model ERM

Model ERM is a module consisting of the energy recovery wheel, wheel motor and pulley in a cassette. This module is utilized in a field-built system where a standard energy recovery model will not meet space restraints. Can be mounted in vertical or horizontal applications. Capacities range from 300 to 10,000 cfm (1,019 to 16,990 m³/hr). ETL Listed.

*Catalog: Recovery Ventilators Preconditioners —
Models MiniVent, ERV, ERVe, MiniCore, ECV and ERM*



Dedicated Outdoor Air Systems



A dedicated outdoor air system (DOAS) is a unit supplying cooled, dehumidified outside air to the building in summer and heated outside air in the winter. Units within this product group are ideal for 100% Outdoor Air or recirculation applications and can be selected with or without energy recovery.

Models RV and RVE

Models RV and RVE are pre-engineered systems available in both 100% outdoor air and recirculating configurations. Designed with packaged direct expansion (DX) capacities between 3 to 70 nominal tons and airflow ranges up to 18,000 cfm (30,582 m³/hr). Modulating hot gas reheat is also available for precise humidity control. This unit is ideal for 100% outdoor air, variable air volume and single zone applications. ETL Listed.

Cooling options: Packaged direct expansion, chilled water, air-source heat pump, and split direction expansion on select models

Heating options: Indirect gas, electric, and hot water

Catalog: Dedicated Outdoor Air Systems for high percentage and 100% outdoor air - RV and RVE



Make-Up Air



Greenheck offers a wide range of make-up air units for commercial, industrial, and kitchen applications. Heating options include direct gas-fired, indirect gas-fired, steam, hot water, and electric heat. Available cooling options are evaporative cooling, packaged direct expansion, split direct expansion and chilled water coils. In addition to Greenheck's make-up air units, Greenheck also offers industrial space heating systems. Industrial space heating systems use direct gas-fired heating technology to deliver high discharge air temperatures into the space. These systems are an economical and efficient option to meet the needs of any industrial space heating application.

Direct Gas-Fired

Models DGX and TSU are direct gas-fired make-up air units that feature burners that are 92% efficient and capable of up to 25:1 turndown. These units can be configured with different cooling options, air volume arrangements, and control options to fit a wide variety of applications.

Model DGX

Model DGX is a highly configurable direct gas-fired heating and cooling system. The unit incorporates a modular design to maximize configuration flexibility. In addition, constant volume, 100% outdoor air, recirculation, and VAV airflow arrangement are available. The DGX can be configured with a forward-curved, backward-curved or mixed flow plenum supply fan allowing for either belt-driven or drive arrangements.

Features: 800 to 48,000 cfm (1,359 to 81,533m³/hr) and 4 in. wg (996 Pa). Up to 4,800,000 BTU/hr. Cooling options: packaged direct expansion (DX), split direct expansion (DX), chilled water, or evaporative cooling. ETL listed.

Catalog: Direct Gas-Fired Make-Up Air - DG, DGX, TSU, and VSU



Model TSU

Model TSU is a configurable, direct gas-fired heating make-up air unit. In addition, constant volume 100% outdoor air operation, recirculation, and VAV airflow arrangements are also available.

Features: 33,000 to 64,000 cfm (56,067 to 108,737m³/hr) and 3 in. wg (747 Pa) Up to 7,000,000 BTU/hr. Optional evaporative cooling. ETL Listed.

Catalog: Direct Gas-Fired Make-Up Air - DG, DGX, TSU, and VSU



Model VSU

Model VSU is a vertically configured direct gas-fired heating make-up air unit that offers a wide range of CFMs. The vertical configuration removes the equipment weight loading from the roof and offers a simplified means of installation. Ground level filters, dampers, and controls greatly simplify equipment start-up and maintenance.

Features: 800 to 64,000 cfm (1,359 to 108,737 m³/hr) and 3 in. wg (747 Pa) Up to 7,000,000 BTU/hr. ETL listed.

Catalog: Direct Gas-Fired Make-Up Air - DG, DGX, TSU, and VSU



Indirect Gas-Fired

Indirect gas-fired heating make-up air units feature 80% total efficient furnaces offering modulating control options with up to 16:1 turndown per furnace. These units can be configured with different cooling options, air volume arrangements, and control options to fit a wide variety of applications.

Model IGX

Model IGX is a highly configurable indirect gas-fired heating system. The unit has a modular design for maximum flexibility. Recirculation and VAV options are available in addition to constant volume, 100% outdoor air operation. The IGX has heating, cooling, and airflow capacities to provide make-up air across a broad range of applications.

Features: 800 to 15,000 cfm (1,359 to 25,485 m³/hr) and 3 in. wg (747 Pa). Heating capacity up to 1,200,000 BTU/hr. Cooling options: packaged direct expansion, split direct expansion, chilled water, or evaporative cooling. ETL listed.

Catalog: Indirect Gas-Fired Make-Up Air — IG and IGX



Non-Gas-Fired Heating

Non-gas-fired make-up air units are configurable with electric, hot water, or steam coils to meet the needs of a variety of applications. These units can be configured with different cooling options, air volume arrangements, and control options to fit a wide variety of applications.

Model MSX

The MSX is a highly configurable make-up air unit that can be utilized to meet the needs of a variety of applications. The MSX's modular design allows for a wide range of heating, cooling, and filtration options.

Features: 800 to 48,000 cfm (1,359 to 81,522 m³/hr) and 4 in. wg (996 Pa) Heating options: hot water, steam, electric heat. Cooling options: packaged direct expansion, split direct expansion, chilled water, or evaporative cooling. ETL listed.

Catalog: Modular Make-Up Air Unit — MSX



Non-Tempered

Models MSF, TSF, KSFB, KSFD are configurable for applications that do not call for heating or cooling. Configurable air volume arrangements are available for a wide variety of applications.

Model MSF

Model MSF is for price sensitive, non-tempered make-up air applications. The MSF features a direct drive, backward inclined plenum supply fan that provides many value-added benefits for the end user. The plenum fan arrangement allows for bottom, horizontal, left and right discharge arrangements for convenient ducting. Maintenance and air balancing in the field are simplified with this direct drive arrangement.

Features: 500 to 5,300 cfm (850 to 9005 m³/hr) and 3 in. wg (747 Pa) Vari-Green[®] electronically commutated (EC), or variable frequency drive (VFD) controlled three-phase motors. UL705.



Model TSF

Model TSF is a full feature make-up air unit commonly used for industrial and commercial applications. The TSF can be configured as constant volume 100% outside air or variable air volume. The TSF model can also be configured to include evaporative cooling.

Features: 33,000 - 64,000 cfm (56,067 to 108,737 m³/hr) and 3 in. wg (747 Pa). ETL Listed.



Models KSFB and KSFD

The KSF series has both a belt drive (model KSFB) and direct drive (model KSFD) configuration. Both have a compact design and provide a great source of non-tempered make-up air for commercial, institutional and kitchen applications.

Features: 300 to 10,250 cfm (509 to 17,415 m³/hr) and 3 in. wg (747 Pa). UL 705

Catalog: Untempered Make-Up Air for Kitchen Systems — KSFB and KSFD



Industrial Space Heat

Industrial space heating systems heat large spaces comfortably and economically. The 92% thermally efficient direct gas-fired burners promote excellent space comfort and low operating cost. The space heating line includes 100% outdoor air and 80/20 recirculation systems. These systems provide many options to meet the needs of any space heating application.

100% Outdoor Air Space Heating Systems

The 100% outdoor air systems provide a great option for low insulated spaces with high infiltration rates such as warehouses and distribution centers. These units cycle the blower and burner on a call for heat from the space, supplying air at a high velocity and high discharge temperatures (120°F to 140°F).

Features: 5,000 to 19,000 cfm (8,495 to 32,821 m³/hr) and 1.3 in. wg (322 Pa).



80/20 Recirculation System

The 80/20 recirculation system is a hybrid make-up air system. Supply air is a variable mixture of return air and fresh outdoor air. Outdoor air volumes vary from 20% to 100% of total airflow, often configured to respond to building pressure fluctuations. The 80/20 units are excellent for facilities with mechanical exhaust systems, especially when the exhaust volume is variable. The supply fan will run continuously to respond to varying exhaust volumes, and the burner will modulate to satisfy the remote space set point. Discharge temperatures typically range from 70°F to 110°F.

Features: 3,100 to 48,000 cfm (5,266 to 81,552 m³/hr) and 4 in. wg (996 Pa).

Catalog: Industrial Space Heating — Direct Gas-Fired Heating



Indoor Air Handlers, Fan Coils and Coils



Greenheck offers a wide range of products with the ability to heat, cool and/or filter air for commercial, educational, institutional, residential and multistory buildings. Our products incorporate premium quality construction features such as double-wall construction, low profile/condensed housing sizes, stainless steel insulated drain pans, internal neoprene or spring isolation, high-efficiency filters and energy efficient motors. These construction features ensure better indoor air quality and the energy efficiency preferred by owners and engineers for LEED- or “green-” type projects. Whether your project calls for horizontal, vertical or low profile installations, we have the product to fit your needs. We also have a comprehensive line of booster and custom-built coils for your HVAC heating and cooling requirements.

Indoor Air Handlers and Fan Coils

Greenheck’s indoor air handling and fan coil series, models MSCF, LFC and VFC provide tempered supply air for schools, office buildings, medical facilities, hotels, and many other commercial applications. These units are designed for horizontal or vertical installations, and are ideally suited for retrofit applications as well as new installations. Each model is offered in various sizes to meet a wide range of performance requirements and all are designed with premium quality construction features for years of trouble-free operation.

Model MSCF

Model MSCF incorporates an ultra-low profile and modular design allowing for a highly configurable indoor air handler that is ideally suited for retrofit applications as well as new installations in schools, medical facilities, office buildings, and many other commercial applications. The forward-curved and backward-inclined wheel options offer increased performance capabilities for higher static pressure applications. The unit design provides for easy access to components, double-wall construction, and internal neoprene or spring isolation. Model options include: mixing boxes (with or without filters and dampers), plenums (12 or 24 in.), coils (hot water, steam, chilled water, and direct expansion), and filters (2 or 4 in. 30%, 65%, or 95% efficiencies). Ultra-low profile housings ranging from 11 to 26 inches. Capacities range from 400 to 6,000 cfm (679 to 10,194 m³/hr) and 4 in. wg (995 Pa).

Catalog: *Indoor Air Handling Units — IAH Series (MSCF)*



Model LFC

Model LFC incorporates an ultra-low profile, condensed housing design that provides a lower cost alternative to the MSCF unit, while still allowing for customizable options. This blower coil unit is ideally suited for horizontal installations with limited space constraints. The unit design provides for easy access to components, double-wall construction, and internal neoprene or spring isolation. Two forward-curved wheel options are available for low or high pressure applications providing a wide performance range and quiet operation. Capacities range from 400 to 5,000 cfm (679 to 8,495 m³/hr) and 4 in. wg (995 Pa). OSHPD seismic certified.

Catalog: *Indoor Air Handling Units — IAH Series (LFC)*



Model VFC

Model VFC is a belt drive unit with a forward-curved wheel designed for vertical installations. This fan coil is ideal for concealed applications where a small footprint is required. The unit construction includes a steel double-wall cabinet with hinged access to the blower section. Capacities range from 400 to 4,000 cfm (679 to 6,796 m³/hr) and 3.5 in. wg (871 Pa)

Catalog: *Indoor Air Handling Units — IAH Series (VFC)*



Custom Coils

Custom-built replacement coils restore comfort and prevent damage. The Quick Build program builds and ships replacement coils, turning around orders in one to 25 days to meet your requirements. Coils are available for the OEM channel in a wide range of custom sizes and material options. Use the coil selection software for quick, efficient parameter specification to receive the exact replacement needed.

Coil Types:

- Chilled Water
- Hot Water
- Heat Reclaim
- DX Evaporator
- Condenser
- Standard Steam
- Non-Freeze Steam Distributing
- Booster/Duct Mounted

Catalog: *Greenheck Coils*

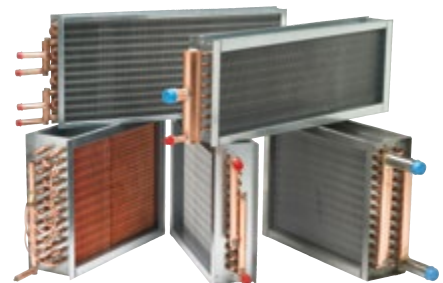

Duct Heaters



Greenheck duct heaters are specifically designed to meet the demanding requirements for many applications including space heating, primary heating, supplemental heating or reheating. Greenheck duct heaters are configurable, giving you the flexibility to customize your heater for a specific application while maintaining the quality, consistency, and value of a standardized product.

Duct Heaters

All heaters are UL/CSA Listed. Both models feature a fan interlock, power terminal board, control terminal board, grounding lugs, automatic limit switch for primary over temperature protection, and manual reset limit switch for secondary over temperature protection.

Model IDHB

The IDHB series is the most cost-conscious model, offering limited sizes and the most basic option and control packages.



Model IDHE

The IDHE series is designed for universal airflow orientation, making it the industry's most versatile and easiest to configure electric duct heater.



Model IDHE-O

The IDHE-O is a duct heater that is UL listed for outdoor applications. This duct heater can be mounted in multiple positions like the IDHE.

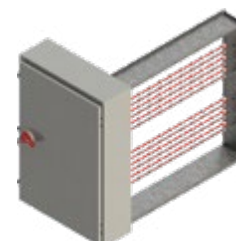

Dampers



Greenheck offers the largest selection of AMCA certified dampers and UL classified life-safety dampers in the industry. Our state-of-the-art damper test lab allows us to accelerate new product development to meet the most challenging applications. And our five regional manufacturing locations give us unmatched production capacity and proximity to market.

Air Measuring Products

Air measuring products help buildings meet the minimum outdoor air requirements of ASHRAE Standard 62 or California Title 24 by providing accurate monitoring and control of outside air.

Airflow Measuring Station

Model AMS

The AMS is an accurate airflow measuring station and is furnished with a properly sized pressure transducer that outputs a signal proportional to CFM. The AMS is compatible with a field-supplied controller or a factory-supplied LON controller to indicate airflow volume.



Airflow Measuring Station with Damper - Pressure Differential

Model AMD

The AMD series combines the function of an accurate airflow measuring station and a low-leakage control damper into one compact assembly that both measures and regulates airflow volumes to a target set point. The AMD series is compatible with a field-supplied controller or a factory-supplied analog controller. The four available models are:

- AMD-23 featuring a 3-V blade control damper
- AMD-33 featuring a fabricated airfoil blade control damper
- AMD-42 featuring an extruded airfoil blade control damper
- AMD-42V featuring a vertical extruded airfoil blade control damper



Airflow Measuring Station with Damper - Thermal

Model AMD-xx-TD

The AMD series combines the function of an highly accurate thermal dispersion airflow measuring station and a low-leakage control damper into one compact assembly that both measures and regulates airflow volumes to a target set point. The AMD-xx-TD series is compatible with a field-supplied controller or a factory-supplied analog or BACnet MS/TP controller. The four available models are:

- AMD-23-TD featuring a 3-V blade control damper
- AMD-33-TD featuring a fabricated airfoil blade control damper
- AMD-42-TD featuring an extruded airfoil blade control damper
- AMD-42V-TD featuring a vertical extruded airfoil blade control damper

Catalog: *Air Measuring Damper Products – AMS, AMD and AMD-TD*



Control Dampers

Control dampers are used in buildings to regulate the flow of air in an HVAC system. Greenheck control dampers are configurable to meet the requirements of most commercial applications. Configurable features include: material type (galvanized steel, stainless steel, and aluminum), blade type (3V, airfoil, and round), and actuator type (two position, three position and modulating). When provided with blade and jamb seals, Greenheck control dampers meet the IECC (International Energy Conservation Code) leakage requirement of 3 cfm/ft² at 1 in. wg (5 m³/hr at 248 Pa).

3-V Blade Type: Models VCD/SEVCD*

3-V blades are typically used in low to medium static pressure and velocity systems. Fabricated blades are reinforced with three longitudinal structurally designed vee's. Available with blade and jamb seals for low leakage applications.



Airfoil Blade Type: Models VCD/SEVCD*

Airfoil blades are typically used in medium to high static pressure and velocity systems. Airfoil blades are constructed with structural reinforcement through the entire length of the blade. All models include blade and jamb seals for low leakage and ultra-low leakage applications.

Round Blade Type: Models VCDR/VCDRM

Round blade types are typically used in low to medium static pressure and velocity systems. Available with blade and jamb seals for low leakage applications. The VCDR uses a single blade design while the model VCDRM uses a multiblade design.



Face & Bypass Type: Models FBH/FBV

Face and Bypass models consist of two dampers connected allowing one damper to open while the other damper closes. The FBH series is a horizontal assembly (dampers alongside each other). The FBV series is a vertical assembly (dampers stacked on top of each other).

Catalog: HVAC Control & Balancing Dampers — VCD, MBD and RBD

Insulated/Thermally Broken Dampers

Model ICD series of dampers were developed for applications where it is necessary to minimize thermal transfer and reduce condensation.

Insulated Control Damper Model ICD

Model ICD-44 features a thermally broken insulated blade. ICD-45 features a thermally broken, insulated frame and blade. The ICD series meets the IECC (International Energy Conservation Code) requirements with a leakage rating of 3 cfm/ft² (5 m³/hr) at 1 in. wg (248 Pa) or less.

Catalog: HVAC Control & Balancing Dampers — VCD, MBD and RBD



Access Doors

Access doors are designed for use in low to medium pressure duct systems. They provide a durable, practical, and inexpensive means of gaining access to damper components inside the ductwork.

- Hinged Style: Model HAD**
- Cam Style: Model CAD**
- Round Style: Model RAD**
- Pressure Relief: Models PRAD/VRAD**



* SE in model name denotes 316 stainless steel.
**SS in model name denotes 304 stainless steel.

Balancing

Models MBD/MBDR

Models MBD and MBDR are designed to regulate the flow of air in an HVAC system. Round and rectangular single-blade, and multiblade construction models are available. Models are standard with a locking manual quadrant. An optional standoff bracket is available for installations using insulated duct.

Catalog: HVAC Control & Balancing Dampers — VCD, MBD and RBD



Models RBD/RBDR

Models RBD and RBDR series offer the same function as MBD/MBDR series plus the added benefit of remote damper control at the diffuser or wall plate. These remote balancing dampers are ideal for applications where it is difficult to get access to manually adjust the dampers and balance airflow. The “EZ Balance” remote control operates the damper motor by connecting to the wall, ceiling, or diffuser mounted RJ11 connector.

Catalog: HVAC Control & Balancing Dampers — VCD, MBD and RBD



Automatic Balancing Dampers

Automatic balancing dampers self adjust to system pressure changes to maintain constant airflow. They are used in residential or commercial buildings to provide precise and automatic airflow regulation in supply or exhaust ventilation systems.

Model ABD

The ABD is an automatic balancing damper with the blade calibrated to automatically adjust to changing pressures.



Model ABD-FD

The ABD-FD is an automatic balancing damper with a UL 555 rated 1 1/2 or 3 hour static fire damper.



ABD-RB

The ABD-RB combines an automatic balancing damper (model ABD) with the convenience of a factory-supplied register box.

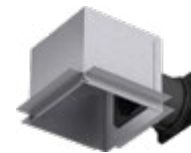

Model ABD-T

The ABD-T is an automatic balancing damper with a square transition.



Model ABD-Z1

The ABD-Z1 has a shutoff damper with an electric actuator, automatic balancing damper (ABD), and a plenum box as one assembly.



* SE in model name denotes 316 stainless steel.
 **SS in model name denotes 304 stainless steel.

Backdraft and Pressure Relief Dampers

Backdraft dampers are designed to allow airflow in one direction and prevent reverse airflow. A variety of mounting orientations, airflow directions, operation types, and performance ratings are available.

Backdraft

Models BD/WD/ES/EM/HB/HBR/WDR/SSWDR**

Exhaust Backdraft Damper models are designed to allow exhaust airflow but prevent airflow in the reverse direction and are typically used with a fan or power roof exhauster. Available in vertical or horizontal mount.

Intake Backdraft Damper models are designed to allow supply airflow into a building but prevent airflow in the reverse direction and are typically used with a fan or gravity intake ventilator. Available in vertical or horizontal mount.



Barometric Relief

Models BR/SEBR*

Barometric relief backdraft dampers have an adjustable start-open pressure for low velocity systems. Typically used for gravity hood ventilation, ductwork outlets, and room or stairwell pressurization.



Pressure Relief

Model HPR

Pressure relief backdraft dampers have an adjustable start-open pressure which is capable of maintaining pressure at various airflows and closes upon a decrease in differential pressure. Pressure relief dampers are typically used in industrial systems to relieve unexpected overpressure, or to admit additional air to a direct gas-fired burner or fume exhaust.



Catalog: *Backdraft and Pressure Relief Dampers*

Fire Dampers

Fire dampers are required by building codes to maintain the fire resistance ratings of walls, partitions, and floors that are penetrated by air ducts or transfer openings. Fire dampers are UL 555 Classified with a fire resistance rating of 1½ or 3 hour.

Dynamic-Rated

Models DFD/SEDFD*/DFDR/ODFD/SSDFD**/SSDFDR**

Dynamic-rated fire dampers are designed to close under airflow and in HVAC systems that are operational in the event of a fire emergency. Fire dampers can be mounted either vertically or horizontally with airflow in either direction.

Catalog: *Life Safety Dampers*



Static-Rated

Models FD/OFD/FDR/SSFD**/SSFDR**

Static-rated fire dampers are designed for use in HVAC systems that are automatically shut down in the event of a fire emergency. Static fire dampers are not designed to close against airflow.

Catalog: *Life Safety Dampers*



Ceiling Radiation Dampers

Ceiling radiation dampers are designed and tested to protect penetrations through the ceiling membrane of fire-resistive floor ceiling and/or ceiling assemblies.

Ceiling Radiation – Model CRD

Model CRD is a UL 555C Classified ceiling radiation damper that is used for protection of ceiling openings in fire-rated floor/ceiling assemblies with fire resistance ratings of 3 hours or less. In addition, Greenheck CRDs are Warnock Hersey Listed for application in gypsum board ceilings or ceiling grid systems with fire resistance ratings of up to 3 hours. Models are available in round or rectangular shapes with butterfly-type blades or a curtain blade.

Catalog: *Life Safety Dampers*



Model CRD-1WJ

The CRD-1WJ is a UL 555C Classified ceiling radiation damper for installation in wood joist ceiling construction and approved for use in 17 ceiling designs as detailed in the UL Fire Resistance Directory. The CRD-1WJ provides the ceiling radiation damper installed in an insulated steel enclosure with C, O or R inlet shapes to connect to ductwork. The damper is positioned in the enclosure to accommodate 1½ in. (38mm) grille depth.

Catalog: *Life Safety Dampers*

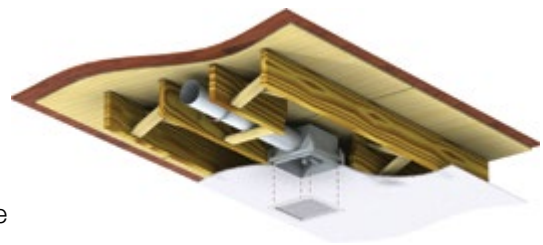

Models CRD-1WT/CRD-2WT

The CRD-1WT and CRD-2WT are UL 555C Classified ceiling radiation dampers for installation in wood truss ceiling construction. These assemblies are given proprietary design numbers listed in the UL Fire Resistance Directory. The CRD-1WT and CRD-2WT models are provided with a flange attached around the perimeter of the damper. The damper is positioned either flush with the ceiling or above the ceiling for grille installation.

Catalog: *Life Safety Dampers*

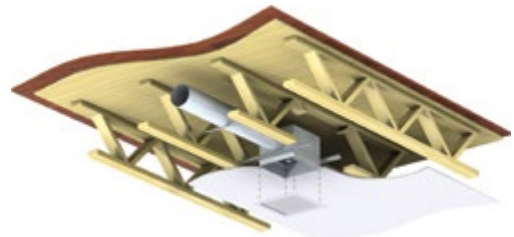

Model CRD-501

The CRD-501 is a round ceiling radiation damper with low leakage. This model is UL 555C and UL 555S Classified. The CRD-501 has been qualified to 3000 ft./min (15 m/s) and 4 in. wg (1,000 Pa) for operational closure in emergency smoke control situations for use in HVAC systems.

Catalog: *Life Safety Dampers*



* SE in model name denotes 316 stainless steel.
 **SS in model name denotes 304 stainless steel.

Smoke Dampers

Smoke dampers are designed to be used in conjunction with barriers within a building to control the spread of smoke in the event of a fire. Greenheck smoke dampers have been certified to UL 555S for use in systems up to 4000 ft./min or 8 in. wg. All models are rated for airflow and leakage in either direction.

Smoke – Models SMD/SMDR/SESMD*/SESMDR*/SSSMD**/SSSMDR**

Smoke damper models are available in leakage class I, II, or III. Smoke dampers can be constructed of galvanized steel, 304SS, or 316SS and are available with a variety of actuators to meet the requirements of any application.

Catalog: *Life Safety Dampers*



Combination Fire Smoke Dampers

Combination fire smoke dampers perform the function of both a fire damper and a smoke damper. Combination fire smoke dampers are UL 555 and UL 555S Classified with fire resistance for 1½ or 3 hours. Models are rated for use in systems up to 4000 ft./min or 8 in. wg. Greenheck’s combination fire smoke dampers have a factory-installed actuator.

Traditional Fire Smoke – Models FSD/FSDR/SEFSD*/SEFSDR*/SSFSD**/SSFSDR**

Combination fire smoke dampers are Classified to UL 555 and UL 555S and must be mounted within the plane of the wall or floor.

Catalog: *Life Safety Dampers*



Corridor Fire Smoke – Model CFSD

Corridor fire smoke dampers have a one hour fire resistance rating and UL 555S Leakage Rating. The dampers can be installed horizontally behind grilles and diffusers in corridor penetrations.

Catalog: *Life Safety Dampers*



Out-Of-Wall Fire Smoke – Model OFSD

OFSD dampers are Classified to UL 555 and UL 555S and can be installed outside of the plane of the wall or floor. The entire installation can be done from the grille side of the opening.

Catalog: *Life Safety Dampers*



Grille Access Out-Of-Wall Fire Smoke Model GFSD

GFSD dampers are Classified to UL 555 and UL 555S and can be installed outside of the plane of the wall or floor. This allows the actuator to be mounted internally with convenient access to the damper, actuator, and heat responsive device through the grille. A separate compartment houses the actuator allowing for a shallow operating depth.

Catalog: *Life Safety Dampers*



Bubble-Tight Dampers

A bubble-tight damper is a heavy-duty damper designed for isolation applications to meet the requirement for zero leakage. Every bubble-tight damper is factory leakage tested to ensure a bubble-tight seal up to 30 in. wg. Galvanized, 304 or 316 stainless steel. These models are recommended for two position shutoff applications.

Models HBTR/HBT

Model HBTR-151 is rated for pressures up to 10 in. wg (2,490 Pa)

Model HBTR-451/551 is rated for pressures up to 30 in. wg (7,470 Pa)

Model HBT-221 is rated for pressures up to 10 in. wg (2,490 Pa)

Catalog: *Bubble-Tight Dampers*

Catalog: *Heavy-Duty/Industrial Dampers*



Blast Dampers

A blast damper is a heavy-duty damper designed to protect against blasts and rapid pressure changes. A blast damper remains open under normal operating conditions to allow normal airflow.

Model HBS

Model HBS-330/430 will close in the same direction as normal flow.

Model HBS-331/431 will close in the opposite direction as normal flow.

Catalog: *Heavy-Duty/Industrial Dampers*



* SE in model name denotes 316 stainless steel.

**SS in model name denotes 304 stainless steel.

Industrial Control Dampers

Heavy-duty flanged-style frame dampers with various blade styles and pressure classes. Designed to control airflow and provide shutoff in HVAC or industrial process control systems.

Models HCD/SEHCD*: Rectangular

Models HCD/SEHCD are rectangular dampers available with pressure and velocity capabilities up to 45 in. wg (11,161 Pa) and 6000 ft./min (30 m/s).

Model HCDR: Round

Model HCDR is a true round industrial damper available for pressure and velocity capacities up to 20 in. wg (4,960 Pa) and 6500 ft./min (33 m/s).

Catalog: *Heavy-Duty/Industrial Dampers*



Tornado Dampers

A tornado damper is a heavy-duty damper designed to protect against tornadoes and rapid pressure changes. A blast damper remains open under normal operating conditions to allow normal airflow.

Models HTOD

Model HTOD-330 will close in the same direction as normal flow.

Model HTOD-331 will close in the opposite direction as normal flow.

Catalog: *Heavy-Duty/Industrial Dampers*



Tunnel Transit Dampers

Underground road and metro tunnels are some of the most challenging environments in the world. High humidity, dust-laden air, and limited access can make the installation and operation of ventilation systems problematic. Greenheck's HTD series dampers for tunnel specific applications are designed to meet these challenges. Tunnel transit dampers are designed to meet specific portions of UL 555S, NFPA 130 and NFPA 502. They can be designed to 24 in. wg (6 kPa) of pressure and 4000 fpm (20.3 m/s) of velocity. These dampers are leakage tested in accordance with AMCA 500-D.

Models HTD

Model HTD-621 has a double skin flat blade with perimeter seal. Leakage rated at 4 cfm per sq. foot at 12 in. wg (less than $.02 \text{ m}^3/\text{s}/\text{m}^2$ at 3 kPa), approximately 25% of UL Class I allowable.

Model HTD-630 features a fabricated airfoil blade. Leakage meets UL Class I @ 12 in. wg (3kPa).

Model HTD-636 has a fire-rated airfoil blade. This model has been tested in accordance to BS476 for 2 hours. Leakage meets UL Class I @ 8 in. wg (3 kPa).

HTD-640 features an extruded airfoil blade. Leakage meets UL Class I @ 12 in. wg (3 kPa).

Catalog: *Tunnel Transit Dampers — HTD*

Catalog: *Heavy-Duty/Industrial Dampers*



Louvers



Greenheck offers industry-leading AMCA Licensed louvers. Our experienced sales staff and engineers can configure, design and manufacture a wide range of air control and architectural products to meet your highest standards for both performance and aesthetic appeal. Choose from extruded aluminum or galvanized steel louvers in a variety of designs: stationary, combination, adjustable, acoustic, sightproof, thinline, wind-driven rain or Florida Product Approved and Miami-Dade County Qualified. Louvered penthouses, equipment screens, and brick vents are also available. Most products can be finished as painted or anodized in a variety of standard colors or as a custom color match.

Stationary Extruded Louvers

Available in non-drainable, drainable head, drainable blade, and dual drainable blade models. J and K blades with 30 or 45 degree blade angles. AMCA Licensed for Water Penetration and Air Performance (excludes ESID).

Drainable Blade: Models ESD/EDD/EHM

Model ESD drainable blade and EDD dual drainable blade louvers have outstanding resistance to water penetration. Optional 35° blades are also available to maximize free area (ESD-435, 635 and 635HP). EHM louvers offer a recessed mullion design providing a continuous blade appearance. Frame depths: ESD - 2, 4, 6 in.; EDD - 4, 6 in.; EHM - 6 in.

Drainable Head: Models EDJ/EDK/ESID

Models EDJ and EDK incorporate a drainable head member, which further decreases water penetration. Optional 30° blades are also available to maximize free area (EDJ/EDK-430). The ESID-430 has both high free area exhaust blades at the top and weather protective intake blades at the bottom, allowing both air discharge and intake ductwork to be attached behind the louver while preventing the short cycling of air. Frame depths: EDJ - 4, 6 in.; EDK - 4 in., ESID - 4 in.

Non-drainable Blades: Models ESJ/ESK

Models ESJ and ESK are quite similar, except the K-blade design incorporates an additional offset or “rain hook” to provide extra protection against water penetration. Both models offer a hidden mullion design for a continuous blade appearance when multiwide sections are necessary. Frame depths: ESJ - 2, 4, 6 in.; ESK - 4 in.



Catalog: Louver Products (Severe Duty, Stationary, Operable)

Wind-Driven Rain Louvers

Wind-driven rain louvers are Greenheck's most effective louvers in minimizing water penetration through wall openings. Designed to protect air intake and exhaust openings in building exterior walls that are sensitive to the penetration of wind-driven rain. AMCA Licensed for Water Penetration, Air Performance, and Wind-Driven Rain.

Models EVH/EHH/EHV

Models EVH, EHH, EHV incorporate a drainable head member with vertical (EVH) or horizontal (EHH), or vertical back and horizontal front (EHV) rain-resistant blades to provide maximum resistance to wind-driven rain in even the most stringent AMCA 500L test procedure.

Frame depths: EVH - 3, 5 in.; EHH - 2, 4, 5, 6, 7 in. EHV - 5.5, 9 in.

Catalog: Louver Products (Severe Duty, Stationary, Operable)

Catalog: Severe Duty Louvered Products

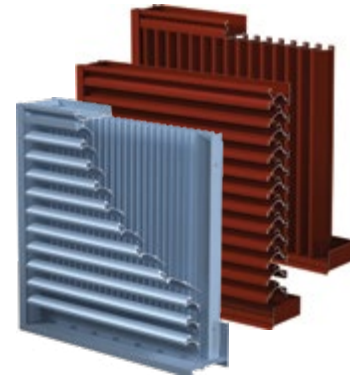

Florida Product Approved/Miami-Dade County Qualified Louvers

Greenheck manufactures a full line of Florida Building Code Approved and Miami-Dade County Qualified louvers, which may be applied in Florida and throughout the Hurricane Prone Region which spans across all Gulf of Mexico and Atlantic Coastal states, including Hawaii.

All Greenheck Florida Building Code Approved and Miami-Dade County Qualified louvers are AMCA 540 Listed for debris impact protection and several are also AMCA 550 Listed for high velocity wind-driven rain.

Greenheck Florida Building Code Approved and Miami-Dade County Qualified louvered penthouses may be applied in any location where high wind loads and debris impact protection is required.

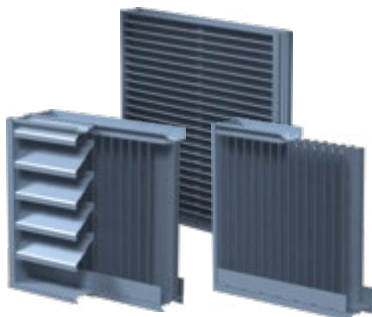

**Miami-Dade County
Qualified Louvers**



**Florida Product
Approved Louvers**



**Miami-Dade County
Qualified Penthouses**

Catalog: Louver Products (Severe Duty, Stationary, Operable)

Catalog: Severe Duty Louvered Products

FEMA 361 Louver

Greenheck louver model AFL-501 is a UL Classified Wind-Storm Rated assembly that meets the requirements indicated within FEMA 361. This model retains extremely high wind load ratings while also passing the ICC 500-14 standard for debris impact testing (15 lb. 2 x 4 traveling at 100 mph).

Catalog: Louver Products (Severe Duty, Stationary, Operable)

Catalog: Severe Duty Louvered Products



Thinline Extruded Louvers

Commonly used for interior or exterior applications where high free area and low airflow resistance are required.

Models ESU/ESJ

Models ESU and ESJ have a narrow frame depth and various frame options that make them ideal products for installation into curtainwalls, windows, door louvers, and as air conditioning grilles. ESU is available in frame or frameless designs and 30° or 48° blade angles. ESJ has J style blades. Frame depths: ESU -153S, 154S - 1.125 in.; ESU-153, 154, ESJ-155 - 1.5 in.

Catalog: Louver Products (Severe Duty, Stationary, Operable))



Adjustable Extruded Louvers

Designed to protect air intake and exhaust openings in exterior building walls. Operable blades can be closed for tight air shutoff. AMCA Licensed for Water Penetration and Air Performance (excludes EAH-690 with blade angle at 45°).

Drainable Blades: Model EAD

Model EAD louvers are designed with drainable blades for maximum resistance to water penetration. Typically operated by electric or pneumatic actuators with manual actuators available. Frame depths: 4, 6 in.

Non-drainable Blades: Model EAH

Model EAH louvers have a drainable head design for increased resistance to water penetration. The EAH-690 has the option of opening to either 45° or 90°. Frame depths: EAH-401 - 4 in.; EAH-690 (45° or 90°) - 6 in.

Catalog: Louver Products (Severe Duty, Stationary, Operable)



Combination Extruded Louver/Dampers

Models combine stationary louver blades and operable blades into one common frame member. Operable blades can be closed for tight air shutoff. AMCA Certified for Water Penetration and Air Performance (excludes EACC, GCI and GCE).

Drainable Blades: Models ECD/EAC/EACC/EACA

Model ECD (exposed), and EAC and EACC (concealed) blade linkages are available. Electric, pneumatic, or manual operation. Concealed actuator in the sill member is available (EACC). Airfoil blade available (model EACA). Frame depths: 4, 6 in.

Gravity: Models GCE/GCI

Models GCE and GCI feature gravity operation which allows airflow in one direction and prevents reverse airflow. GCE is designed for exhaust flow, while GCI is designed for intake. Note: These units must be mounted in direct proximity to an exhaust or intake fan. Frame depth: 4 in.

Catalog: Louver Products (Severe Duty, Stationary, Operable)



Sightproof Extruded Louvers

Sightproof extruded louvers are typically used to prevent visual see-through. Non-drainable, drainable head, and drainable blade models are available. AMCA Licensed for Water Penetration and Air Performance.

Chevron Blade: Model SES

Non-drainable sightproof louver. Frame depth: 2 in.

Drainable Head: Model SEH

The drainable head member provides an increased level of resistance to water penetration. Frame depth: 4 in.

Drainable Blade: Model SED

The drainable blade models are very effective in minimizing water penetration through wall openings. Frame depths: 4, 5 in.

Catalog: Louver Products (Severe Duty, Stationary, Operable)



Acoustical Fabricated Louvers

Acoustical fabricated models incorporate acoustically insulated blades to provide for sound attenuation to lower escaping noise. Independently tested for sound per applicable ASTM standards and AMCA Licensed for Water Penetration, Air and Sound Performance.

J-Blade: Model AFJ

Most economical. Frame depths: 6, 8, 12 in.

Airfoil Blade: Model AFA

Offers highest free area and lowest airflow resistance. Frame depth: 8 in.

Sightproof Blade: Model AFS

Offers best sound absorption performance. Frame depth: 12 in.

Catalog: Louver Products (Severe Duty, Stationary, Operable)

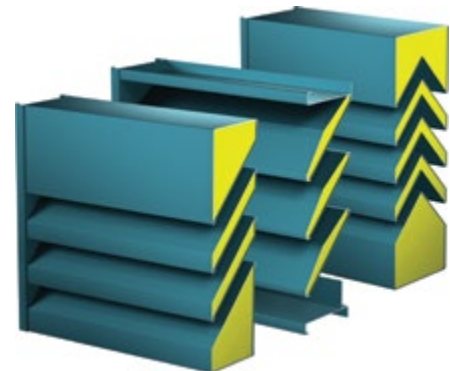

Fabricated Louvers

Fabricated louvers are typically selected where lowest cost is the primary requirement. Fabricated from galvanized or stainless steel, models are available in both non-drainable and drainable blade designs. AMCA Licensed for Water Penetration and Air Performance.

Stationary Blade: Models FSJ/FDS

Models FSJ and FDS steel blade louvers are available in J style blade (FSJ) and drainable blade designs (FDS). Also available in stainless steel. Frame depths: FSJ/FDS - 4, 6 in.

Adjustable Blade: Models FAD

Model FAD louvers are adjustable blade louvers fabricated from galvanized steel and provide similar features as the EAD extruded aluminum models. They are available with drainable blades. Operable blades can be closed for tight air shutoff. Typically operated by electric or pneumatic actuators with manual actuators available. Also available in stainless steel and 35° blade angle. Frame depths: 4, 6 in.

Catalog: Louver Products (Severe Duty, Stationary, Operable)



Sand Louver

Sand louvers are designed to protect air intake and exhaust openings in building exterior walls from wind-driven sand. Design incorporates vertical sightproof blades to separate sand from the airstream which is then channeled out at the sloped sill.

Sightproof Blade: Model FSL-401

Model FSL-401 was tested per ASHRAE Standard Method 52.1-1992 (previously ASHRAE standard 52-76), by an independent third-party test lab using crushed quartz of (150-300 mm) dust medium. Standard construction material is galvanized steel and optional formed aluminum is available. Frame depth: 4 in.

Catalog: Louver Products (Severe Duty, Stationary, Operable)



Penthouses and Equipment Screens

Equipment screens and exhaust or intake penthouse products are available in extruded aluminum or fabricated steel louver models. Custom designs to meet your application requirements are available. Numerous options for construction features and finishes are also available.

Penthouses: Models WIH/WRH

Penthouse models WIH and WRH offer clean horizontal lines, mitered corners, all aluminum construction, removable hoods, and weather-resistant blades. Custom louvered penthouses are also available to meet your specifications.

Model PEV-400

A gravity ventilator comprised of three sides of standard stationary non-drainable louver model ESJ-401, along with one side of 1/8-in. thick plate glass that can be broken with the pressure of a fire hose. A fire smoke damper is located in the throat of the curb and wired into the fire control panel. The unit is shop-assembled and shipped complete.

Model EES-401

For screen applications, standardized model EES-401 is a horizontal equipment screen offering extruded aluminum inverted "J" style blades.

Catalog: Louver Products (Severe Duty, Stationary, Operable)



Brick Vents

Brick vents provide a permanent means of ventilation for crawl spaces, hung ceilings, incinerator rooms, chimney flues, foundations, pipe spaces and corridors. Many standard sizes and finishes are available.

Model BVE

Model BVE features extruded construction that provides a quality, finished appearance. The units are designed with deep-louvered overlapping blades with storm drips on the rear of the blades. The units also have a high water stop at the rear of the unit for maximum protection against rain and weather.

Model BVF

Model BVF features extruded construction that includes an aesthetically pleasing flanged frame for easy installation in existing walls. The units are designed with deep-louvered overlapping blades with storm drips on the rear of the blades. The units also have a water stop at the rear of the unit for maximum protection against rain and weather.

Catalog: Louver Products (Severe Duty, Stationary, Operable)





P.O. Box 410 • Schofield, WI 54476-0410 USA
Phone 715.359.6171 • Fax 715.355.2399
greenheck.com

Corporate All Products | April 2022 | Copyright © 2022 Greenheck Fan Corp.