

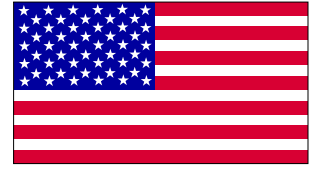

TPI Corporation
P.O. Box 4973
Johnson City, TN 37602
www.tpicorp.com



FSA-Series

Heavy-Duty Flat panel Emitter

Architectural Electric Overhead Infrared Heaters

FSA-14



FSA-43



FSA-65



FSA-31



FSA-95



	! WARNING
	<p style="text-align: center; margin: 0;">IMPORTANT SAFETY INFORMATION INSIDE</p> <ul style="list-style-type: none"> Serious injury or death possible Read, understand and follow all safety information and instructions in this manual before using or servicing this product. Retain these instructions for future use.

! WARNING
<p style="text-align: center; margin: 0;">EXTREMELY HIGH TEMPERATURES ARE PRESENT, DURING OPERATION. MAINTAIN CLEARANCES FROM COMBUSTIBLES AS STATED IN MANUAL.</p>

REFER TO COMPLETE INDEX OF INFORMATION ON PAGE 2.

IMPORTANT INSTRUCTIONS





1. Read all instructions before installing or using the heater.
2. This heater is hot when in use. To avoid burns, do not let bare skin touch hot surfaces. Keep away from combustible materials at minimum, the following required distances. DO NOT install closer than 36 inches to a vertical surface or 24 inches to a ceiling. Heaters MUST BE SEPARATED by more than 36 inches and 87 inches from any combustible surface in direct radiation path.
3. Extreme caution is necessary when any heater is used by or near children or invalids and whenever the heater is left operating and unattended.
4. Do not operate any heater after it malfunctions. Disconnect power at service panel and have heater inspected by a reputable electrician before reusing.
5. Do not use outdoors.
6. To disconnect heater, turn controls to off, and turn off power to heater circuit at the main disconnect panel (or operate internal disconnect switch if provided).
7. Do not insert or allow foreign objects to enter any ventilation or exhaust opening as this may cause an electric shock or fire, or damage to the heater.
8. To prevent a possible fire, do not block air intakes or exhaust in any manner.
9. A heater has hot and arcing or sparking parts inside. Do not use it in areas where gasoline, paint or flammable vapors or liquids are used or stored.
10. Use this heater only as described in this manual. Any other use not recommended by the manufacturer may cause fire, electric shock, or injury to persons.
11. **SAVE THESE INSTRUCTIONS.**

INDEX

General Description & Use	Page 4
Specifications	Page 4, 5, 6
Installation Planning	Pages 7, 8
Installation - Hanging Heaters	Pages 8-11
Installation - Wiring	Pages 12, 14
Operation	Page 13
Maintenance	Page 13

ATTENTION:

The table to the right provides definitions of the signal words that can be found throughout this manual. These signal words are used to express the severity of the hazard at hand. The signal words are generally used in conjunction with safety symbols that correspond to the text for that particular hazard. As you read this manual, refer back to this table when you are unsure of the signal word definition.

SIGNAL WORD DEFINITIONS	
	DANGER indicates an imminently hazardous situation which, if not avoided, will result in death or serious injury
	WARNING indicates an imminently hazardous situation which, if not avoided, could result in death or serious injury
	CAUTION indicates an imminently hazardous situation which, if not avoided, may result in minor or moderate injury
	CAUTION used without the safety alert symbol indicates a potentially hazardous situation which, if not avoided, may result in property damage.
As defined in ANSI Z535-4-2002	

THANK YOU!!

Thank you very much for selecting Fostoria's overhead electric infrared heating equipment for your comfort heating needs. These products were engineered with the most reliable components and materials available and are equipped with features to assure ease of installation and maintenance.

The warmth you will now enjoy when using this heating equipment is created by a heat source; a flat panel emitter; that emits infrared energy in the form of heat, like the sun. This is an economical way to heat because it heats people and objects, not the air, so you don't need to heat a large area to feel warm.

CHECKING YOUR SHIPMENT

- Upon receipt of your shipment, check all cartons for visible damage.
- Claims for damaged material or shortages that were not evident upon receipt of shipment must be reported to carrier and TPI Corporation's customer service (800-251-0382) immediately.
- Any accessory items ordered for the heater will be shipped in separate cartons.

GENERAL DESCRIPTION & USE

WARNING



EXPLOSION HAZARD

FIRE HAZARD

BURN HAZARD



- Serious injury or death may occur
- Not for residential use.
- Do not use outdoors.
- Use for comfort heating only
- Do not use locations containing hazardous or explosive atmospheres



The Fostoria FSA-Series heaters provide safe, efficient electric infrared heat for total area heating or spot heating applications for warehouses, steel mills, machine shops and many other industrial applications. They are ideal for use in high vibration environments. Using the “L” brackets on the top of the housing these overhead heaters can be hung by chain or rigidly mounted. They operate cleanly, emitting no fumes or odors.

Applications where combustible materials and/or personnel will be located near these heaters must adhere to the minimum clearance information below

REQUIRED CLEARANCES

DO NOT install closer than **36 inches** to a vertical surface or **24 inches** to a ceiling. Heaters **MUST BE SEPARATED** by more than **36 inches** and **87 inches** from any combustible surface in direct radiation path.

SPECIFICATIONS

- ETL listed for suspended, high-bay indoor applications (see table on next page)
- High-watt-density radiant heat with 180 degree heat pattern.
- Extruded aluminum housing for commercial applications.
- “L-brackets included for chain suspension or rigid-mounting.
- Designed for direct-wire, single or three-phase configurations (see table next page).

SPECIFICATIONS (con't.)

Heater Models	Voltage And Phase	Amps 1ph.	Amps 3ph.	Number Of Elements	Watts	Btu's/Hr.	cETLus Listed
FSA-1412-1	120; 1ph	12.1	N/A	1	1450	4947	Yes
FSA-1420-1	208; 1ph	6.97	N/A				Yes
FSA-1424-1	240; 1ph	6.04	N/A				Yes
FSA-1427-1	277; 1ph	5.23	N/A				Yes
FSA-1448-1	480; 1ph	3.02	N/A				Yes
FSA-1457-1	600; 1ph	2.52	N/A				Yes
FSA-3120-1	208; 1ph	15.14	N/A	1	3150	10,748	Yes
FSA-3124-1	240; 1ph	13.13	N/A				Yes
FSA-3127-1	277; 1ph	11.37	N/A				Yes
FSA-3148-1	480; 1ph	6.56	N/A				Yes
FSA-3157-1	600; 1ph	5.48	N/A				Yes
FSA-4320-3	208; 1 or 3ph	20.67	11.94				1
FSA-4324-3	240; 1 or 3ph	17.91	10.36	Yes			
FSA-4327-1	277; 1ph	15.52	N/A	Yes			
FSA-4348-3	480; 1 or 3ph	8.96	5.18	Yes			
FSA-4357-3	600; 1 or 3ph	7.48	4.32	Yes			
FSA-6520-3	208; 1 or 3ph	31.3	18.1	1	6500	22184	
FSA-6524-3	240; 1 or 3ph	27.1	15.7	1			Yes
FSA-6527-1	277; 1ph	23.5	N/A	1			Yes
FSA-6548-3	480; 1 or 3ph	13.5	7.8	1			Yes
FSA-6557-3	600; 1 or 3ph	11.3	6.5	1			Yes
FSA-9520-3	208; 3ph	N/A	26.39	1			9500
FSA-9524-3	240; 3ph	N/A	22.89		Yes		
FSA-9527-1	277; 1ph	34.3	N/A		Yes		
FSA-9548-3	480; 3ph	N/A	11.44		Yes		
FSA-9557-3	600; 3ph	N/A	9.54		Yes		

SPECIFICATIONS (con't.)

FSA-14, FSA-31

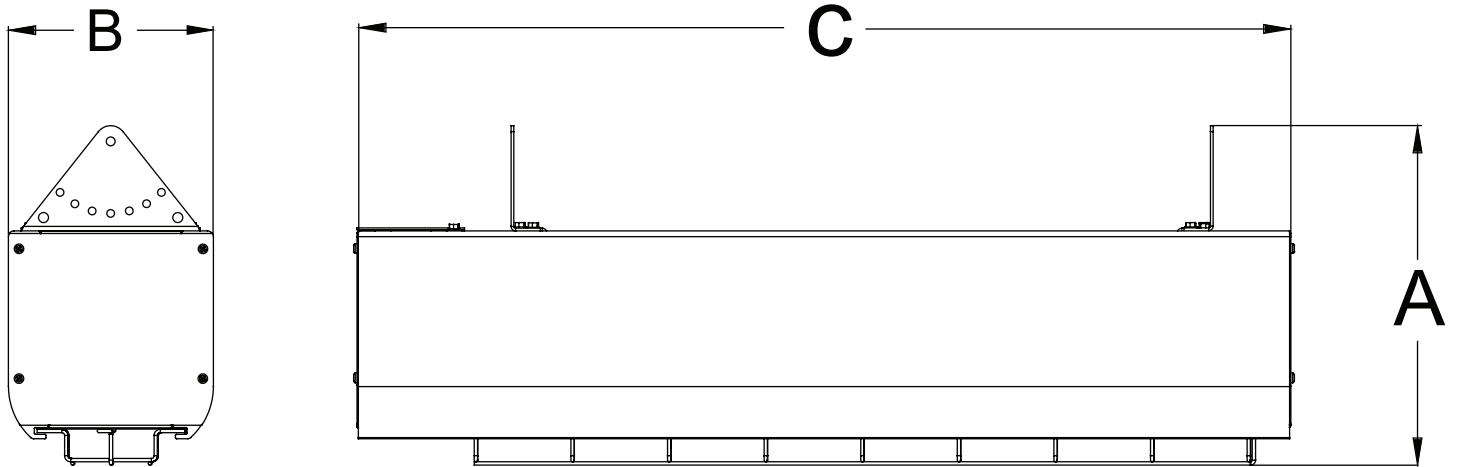

FSA-43, FSA-65, FSA-95

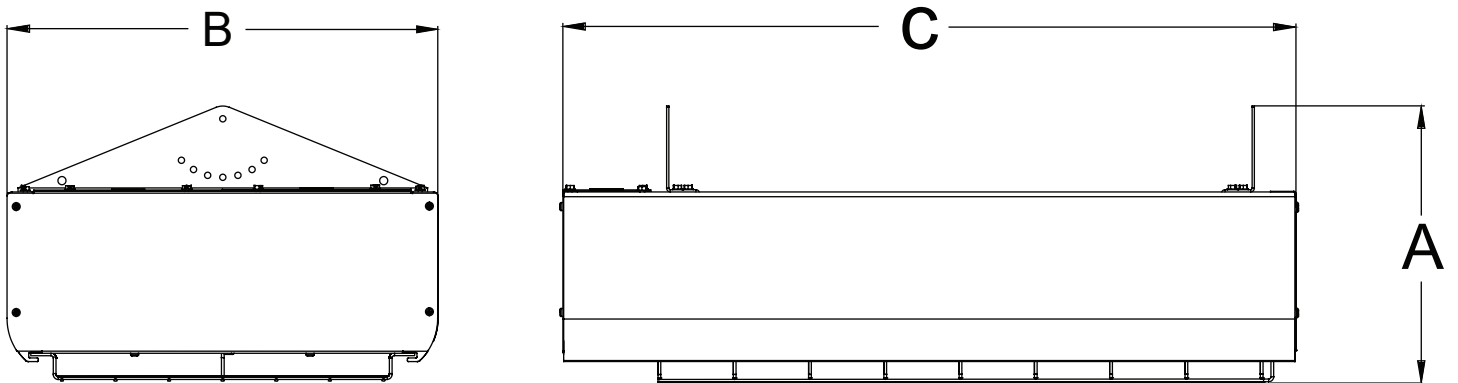

Model Series	Dimension A (inches)	Dimension B (inches)	Dimension C (inches)
FSA-14	9	5-3/4	26-1/16
FSA-31	9	5-3/4	47-1/16
FSA-43	9-1/4	14-3/4	25-1/16
FSA-65	9-1/4	14-3/4	34-1/16
FSA-95	9-1/4	14-3/4	47-1/16

INSTALLATION PLANNING

Fostoria's flat panel emitter heaters are equipped with heating elements that are manufactured using materials with exceptional mechanical and thermal performance and are built with precise process control to provide rugged and reliable infrared performance in challenging environments. It is our understanding that these precision characteristics can change with time, specifically in environments with high humidity or where mechanical damage can occur, causing the internal electrical insulation to weaken.

Installer Qualifications

The installation and wiring of Fostoria FSA heaters must be performed by a licensed electrician.

Installer Responsibility

The National Electric Code (NEC) and local codes and ordinances together with specifications provided by Fostoria comprise the information needed for proper installation.

The installer must furnish all materials that have not been purchased from Fostoria or its representatives. It is the installer's responsibility that the materials and methods of installation result in a job that is workmanlike and compliant with all applicable codes.

	⚠ WARNING
	FIRE HAZARD <ul style="list-style-type: none">• Serious injury or death may occur.• Heater circuit load calculations and circuit design must be done by a licensed electrician or engineer.

Preparations For Hanging Heaters

- Hardware to suspend these heaters from overhead supports (chain, "S"-hooks etc.) is not included with the product. Make certain that the hardware to be used is capable of supporting at least twice the total weight of the heater's in question. Refer to the specifications section of this manual for product weights.
- Identify and use installation locations that are strictly compliant with the clearance-to-combustibles requirements in the installation section of this manual.
- Mounting height is an important consideration to assure satisfaction with the heating performance of infrared heaters. Fostoria has many years of practical experience in the successful application of infrared technology. For that reason, recommended mounting heights have been included in the installation section of this manual. Please refer to this data and select installation points where these recommendations can be followed.

INSTALLATION PLANNING (CON'T.)

Supply Wire Size Recommendations

The table at the right is provided to assist the licensed electrician in sizing the electric supply wires required to deliver power to each individual heater. All branch circuit supply wiring must be copper, rated 90° C minimum and comply with all local codes and the NEC.

All recommended wire sizes assume a 50ft. maximum wire length.

Heater Model	kW	Volts	Amps		Recommended AWG Wire Size	
			3ph	1ph	3ph	1ph
FSA-1412-1	1.45	120	N/A	12.08	N/A	12
FSA-1420-1	1.45	208	N/A	6.97	N/A	12
FSA-1424-1	1.45	240	N/A	6.04	N/A	12
FSA-1427-1	1.45	277	N/A	5.23	N/A	12
FSA-1448-1	1.45	480	N/A	3.02	N/A	12
FSA-1457-1	1.45	600	N/A	2.52	N/A	12
FSA-3120-1	3.15	208	N/A	15.14	N/A	12
FSA-3124-1	3.15	240	N/A	13.13	N/A	12
FSA-3127-1	3.15	277	N/A	11.37	N/A	12
FSA-3148-1	3.15	480	N/A	6.56	N/A	12
FSA-3157-1	3.15	600	N/A	5.48	N/A	12
FSA-4320-3	4.3	208	11.9	20.67	12	10
FSA-4324-3	4.3	240	10.4	17.9	12	10
FSA-4327-1	4.3	277	N/A	15.5	12	12
FSA-4348-3	4.3	480	5.2	9.0	12	12
FSA-4357-3	4.3	600	4.3	7.5	12	12
FSA-6520-3	6.5	208	18.1	31.3	12	8
FSA-6524-3	6.5	240	15.7	27.1	12	8
FSA-6527-1	6.5	277	N/A	23.5	N/A	10
FSA-6548-3	6.5	480	7.8	13.5	12	12
FSA-6557-3	6.5	600	6.5	11.3	12	12
FSA-9520-3	9.5	208	26.4	45.7	8	8
FSA-9524-3	9.5	240	22.9	39.6	10	8
FSA-9527-1	9.5	277	N/A	34.3	12	8
FSA-9548-3	9.5	480	11.4	19.8	12	10
FSA-9557-3	9.5	600	9.5	16.5	12	10

INSTALLATION - HANGING HEATERS

WARNING

FIRE HAZARD

BURN HAZARD

- Install heaters to comply with REQUIRED CLEARANCES listed above at right.
- Do not mount heaters vertically.

REQUIRED CLEARANCES

DO NOT install heaters closer than 36 inches to a vertical surface or 24 inches to a ceiling. Heaters **MUST BE SEPARATED** by more than 36 inches and 87 inches from any combustible surface in direct radiation path.

HEATER HANGING ALTERNATIVES

One method of hanging the heaters (shown below) is with hardware chain and “S” hooks. The chain and “S” hooks must be either 14 or 16 gauge for all models. The heaters also can be mounted “fixed” with angle iron, metal rods or metal straps OR threaded rod.. Whatever means is used to mount the heaters, the terminal box must be **EVEN WITH** or **LOWER THAN** the horizontal plane of the heater housing.

CHAIN MOUNTING

SERIES	RECOMMENDED MOUNTING HEIGHTS
FSA-14	8-10 Ft.
FSA-31	8-12 Ft.
FSA-43	10-14Ft.
FSA-65	10-14Ft.
FSA-95	12-16Ft.

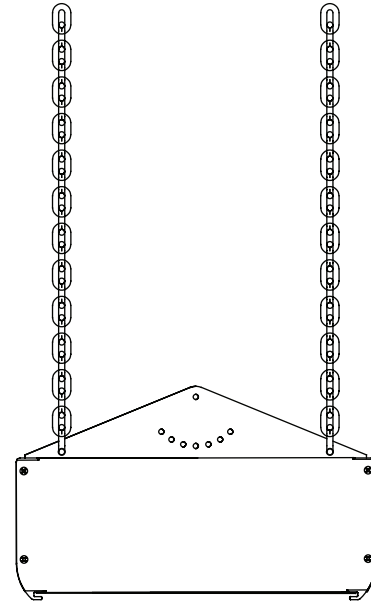

SUSPENSION MOUNTING

Mounting Centers (In Inches)		
Series	Dim. A	Dim. B
FSA-14	19-3/4	3-3/4
FSA-31	40	3-3/4
FSA-43	20	11
FSA-65	29	11
FSA-95	38-1/4	11

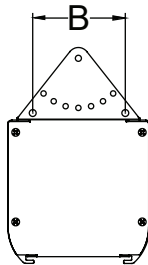
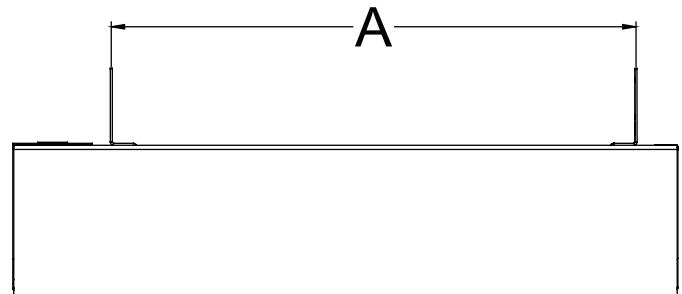
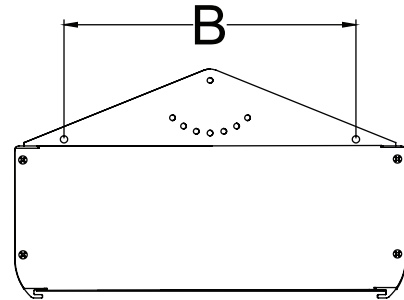

FSA-43, FSA-65 & FSA-95

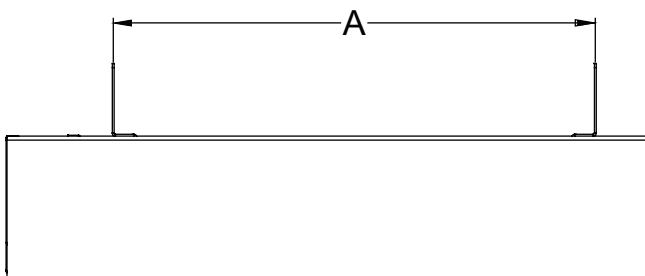

FSA-14, FSA-31

WALL MOUNTING

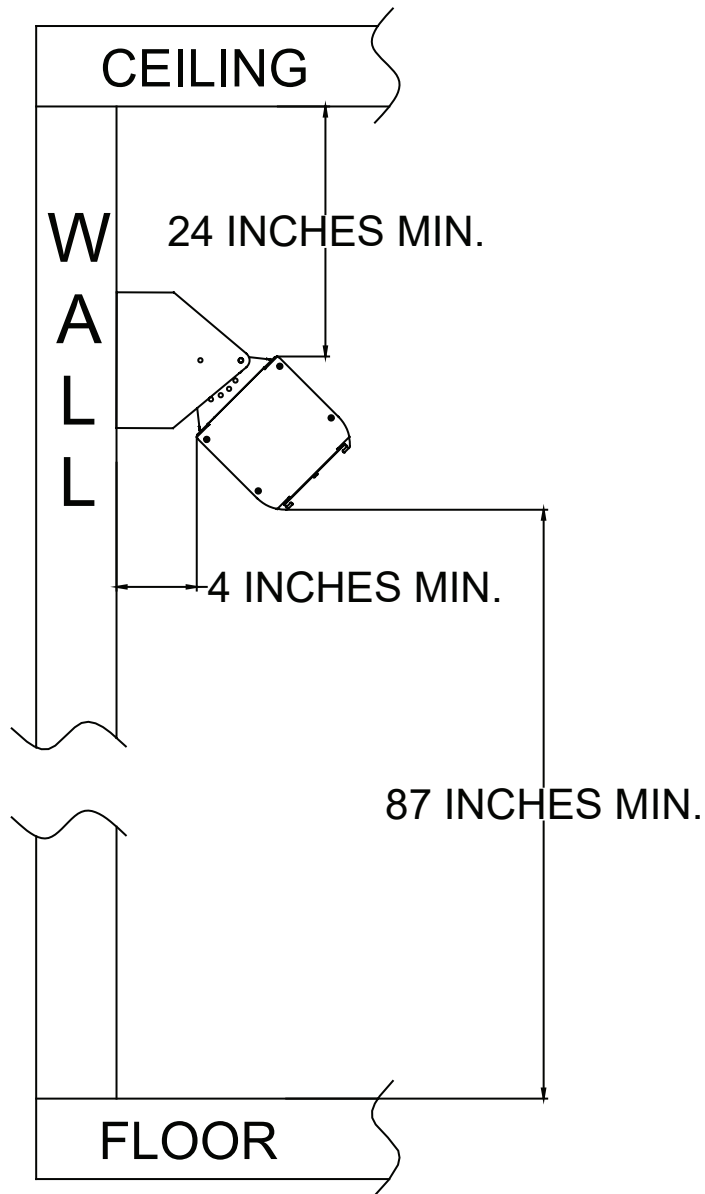

The clearances as shown above are for all FSA models.

RECESSED MOUNTING

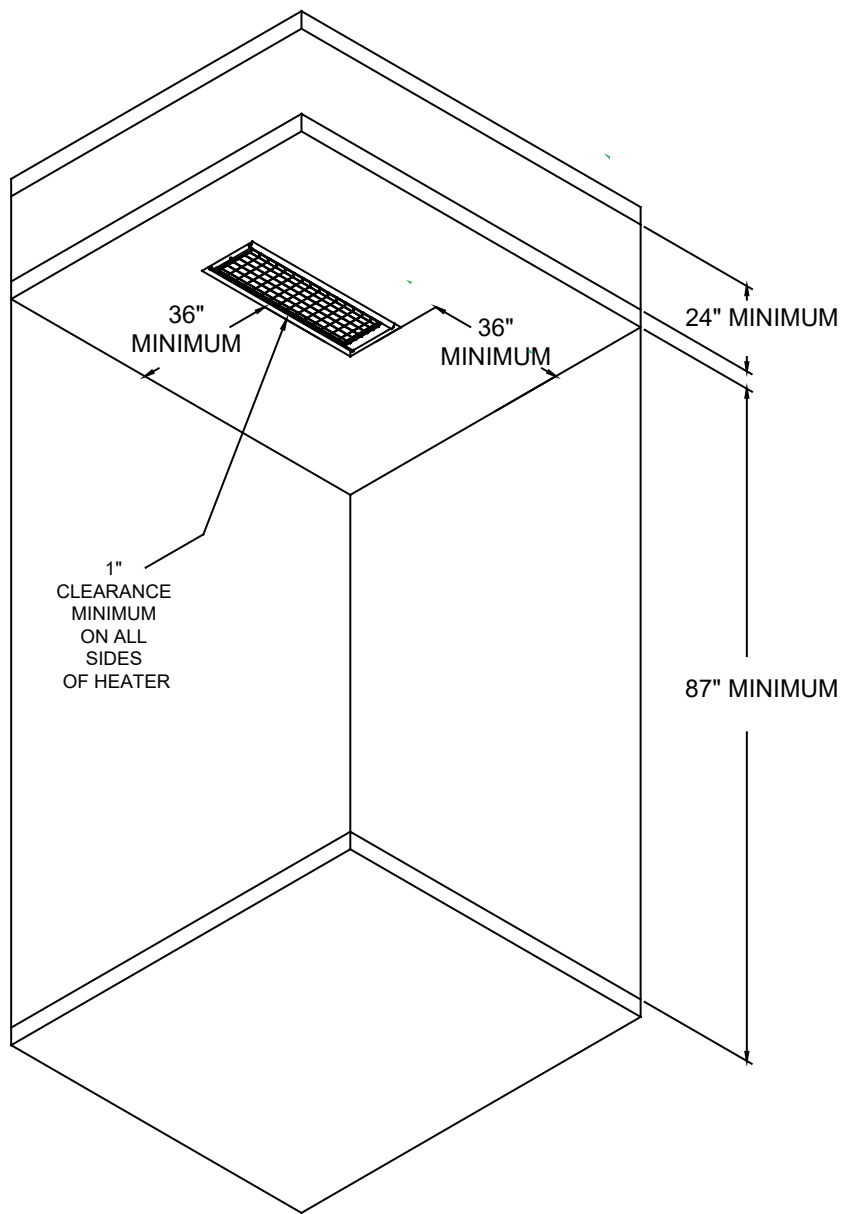

The FSA Series can be fully recessed providing that all clearances are maintained. The FSA Series must have 36 inches minimum of clearance to adjacent walls, there must be 1 inch of clearance between the ceiling and all sides of the heater and 24 inches of clearance above the back of the heater.

INSTALLATION - WIRING

WARNING

ELECTRICAL SHOCK HAZARD



- Serious injury or death may occur.
- Disconnect heater and lock out from electrical supply before installing or servicing.
- Always securely connect green wire on heater to bonding (green) wire from electrical supply.

FOR ALL HEATERS

Wiring procedures and connections shall be in accordance with the national and local authority having jurisdiction. The FSA series heaters do not have any on board controls and therefore must be used in conjunction with an applicable control center or be wired to a listed, properly rated safety switch for on/off control.

Always disconnect the power at the circuit breaker or disconnect switch before installing electric power to the heater. If the breaker or disconnect switch cannot be seen from where you will be working, lock it in the open position and tag it to prevent unexpected application of power. Failure to do so could result in fatal electric shock. Do not depend on a thermostat or other switch as the sole means of turning off power to the heater. When bringing supply wiring to the heater always route it away from the area directly above the heater and away from the sides of the heater where temperatures may be dangerously high.

WIRING OF THE FSA SERIES HEATERS:

1. The FSA-14 and FSA-31 models are available in single phase only. All FSA-43, FSA-65 and FSA-95 models (except the FSA-4327-1, FSA-6527-1 and FSA-9527-1) can be wired for single phase or three phase applications. See wiring diagrams on page 14.
2. Remove the cover from the terminal box.
3. Connect the lead wires to the 90°C rated supply wiring routed into the splice box with wire nuts or other safe mechanical means. Black and white supply leads can be connected to either element lead wire. Be sure green lead from supply and green (bonding) lead from the terminal box are connected.
4. Reinstall splice box cover.
5. Apply power to circuit.

“Bonding is the intentional electrical connection of all non-current carrying metal parts to the equipment grounding (green) conductor of the heater and then terminating this green conductor to the green conductor of the power supply to form a low-impedance path back to the power supply so that safety devices (circuit breakers, fuses) can quickly remove dangerous touch voltage from these parts when a fault occurs.

Always securely connect the green conductor from the power supply to the green conductor of the heater.

OPERATION

	! WARNING
	<p>BURN HAZARD</p> <ul style="list-style-type: none">• Serious injury or death may occur.• Allow heater to fully cool after power is removed (may take minutes) before touching or working on it.

When power is provided to these heaters the heater elements will take several minutes to achieve full infrared output that can be confirmed by an orange to dull red glow on the element surface. The element under this condition is operating between 1,500 and 1,600°F emitting medium wavelength infrared energy. This energy, that can also be considered “radiation” is not harmful, yet is very effective at heating objects and surfaces that are within the line-of-sight of the elements and the heater’s reflective surfaces.

When power is provided or removed from these heaters, you may hear unfamiliar sounds that are caused by the expansion and contraction of metal components in the heater. This is normal.

MAINTENANCE

- Pre-Season Maintenance and Annual Inspection
- To ensure your safety and years of trouble-free operation from the heaters, periodic service and inspections must be done by a trained maintenance person or licensed electrician.
- To obtain maximum performance from your heater(s) each year, we recommend the following be performed at the start of the heating season:
 1. Disconnect power to heater at main panel. Be sure that heating elements have cooled down.
 2. Clean housing surfaces with a damp cloth.
 3. Blow or dust off the element.
 4. Repair or replace damaged power cables.
 5. **DO NOT HOSE-DOWN THESE HEATERS.**

**WIRING SCHEMATIC
FOR FSA-14, FSA-31, FSA-4327-1,
FSA-6527-1 AND FSA-9527-1
MODELS**

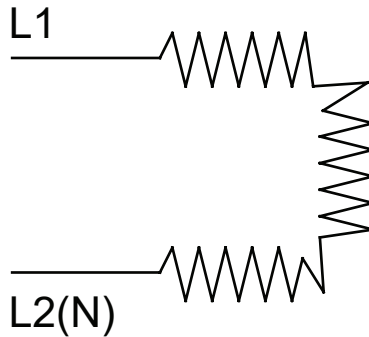

FOR ALL OTHER FSA MODELS

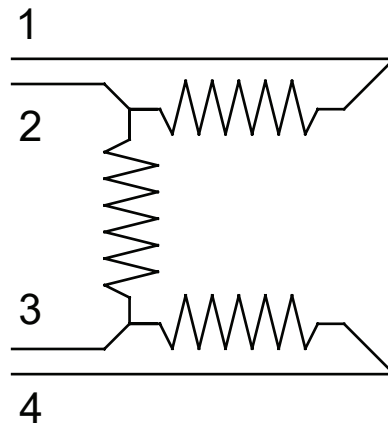

FOR 3PH OPERATION

L1-1 & 4, L2-2, L3-3.

FOR 1PH OPERATION

L1-1 & 3, L2(N)-2 & 4.