



OUELLET



BRITECH



DELTA-THERM
CORPORATION

INSTRUCTION MANUAL

INS427-201401-11 (INS-WS-T-201401-11)

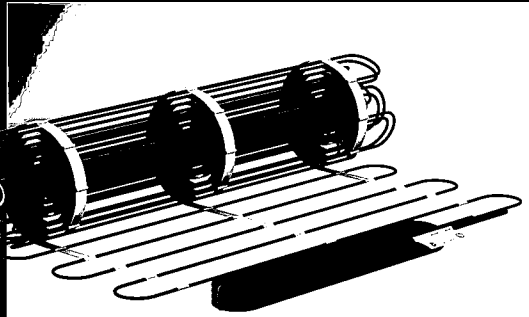

Heating Cable for Snow Melting on Mat

BWS-T Series
DWS-T Series
OWS-T Series
WS-T Series

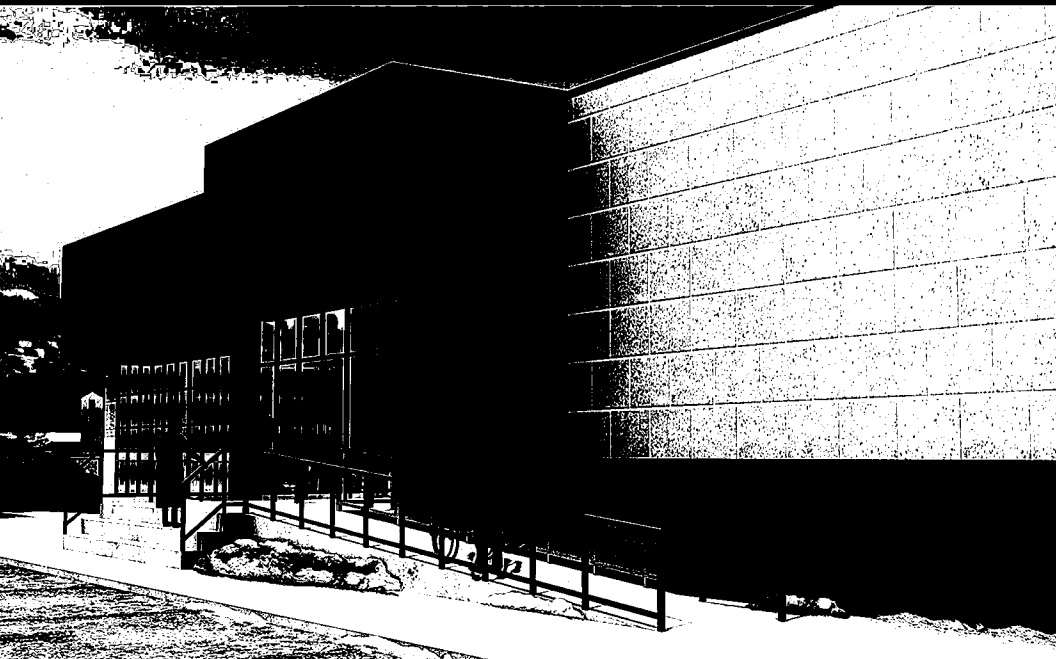

Warranty

Subject to provisions stipulated in the Consumer Protection Act's legal requirements respecting the quality and durability of goods: the manufacturer guarantees its BWS-T, DWS-T, OWS-T and WS-T series heating cables for a period of 10 years from the date of purchase against any manufacturing defect or malfunction.

Limitations and exclusions

The above mentioned guarantees are limited to the reimbursement of the original purchase cost or replacement of the heating cables (hereinafter called "equipment") excluding any other part and also excluding any cost or any expense relating to connection, removal or installation of aforesaid equipment, including all workmanship costs. The buyer may choose between the reimbursement of the original purchase cost and the replacement of defective equipment, subject to the aforementioned restrictions. This warranty is provided to the original buyer of the equipment as well as subsequent owners of the building where the equipment was installed.

Warranty terms

The above mentioned warranties are subject to the following conditions:

- i. The buyer must provide the original purchase invoice for the defective equipment, to the manufacturer or to one of their authorized dealer.
- ii. The buyer must report promptly in writing to the manufacturer any malfunction of equipment covered by the present warranties, in a reasonable time frame, from the time the malfunction occurred or the malfunction was brought to their knowledge thereby enabling the manufacturer's representatives enough time to verify the defective equipment, if need be.
- iii. Equipment covered under the present warranties must be installed in compliance with the manufacturer's instructions.
- iv. Equipment covered under the present warranties must be used under normal conditions of use and be maintained on a regular basis from the date of purchase.

Address of the person providing the present warranties:

180, 3^e Avenue, L'Islet (Québec) G0R 2C0 CANADA

Telephone: 1 800 463-7043 or 418 247-3947

Customer service

If you have any questions about this product, please contact our technical support team:

 OUELLET	Canada: 1 800 463-7043 • info@ouellet.com • www.ouellet.com USA: 1 800 525-3622 • USAinfo@ouellet.com • www.ouellet.com
 BRITECH	1 877 335-7790 • info@britech.ca • www.britech.ca
 DELTA-THERM <small>CORPORATION</small>	1 800 526-7887 • info@delta-therm.com • www.delta-therm.com



Table of contents

1. Warnings and cautions	4
2. Product specifications and details	5
2.1. Technical features	6
3. Heating cable insulation and electrical resistance tests	7
4. Construction planning	8
4.1. Installation plan	9
4.2. Required materials	10
5. General installation guidelines	11
5.1. Preparation of foundation	11
5.2. Equipment verification	11
5.3. Clearance and bypass distances	12
5.4. Anchoring heating cable to foundation base	13
5.5. Installation of ground sensor conduit	14
6. Installation guidelines per type of coating	15
6.1. Concrete slab (one pour)	15
6.2. Asphalt	17
6.2.1. Double pour	17
6.2.2. Single pour	19
6.3. Brick, concrete or natural stone paving	21
6.4. Concrete stairs (two pours)	23
7. Electrical connection	25



CAUTION!

Please read through these instructions carefully before you begin installing & check that you are aware of all the components required.

1 Warnings and cautions



Risks of electrical shocks and fire



Operate snow melter Systems only as required to melt snow and ice.

For safe installation and efficient performance of this system, read the instruction manual thoroughly and keep it handy.

- Where applicable, installation must meet requirements of the following codes :
 - Canadian Electrical Code (CSA C22.1 Part 1);
 - National Electrical Code (NFPA 70);
 - Any other applicable local and/or national code.
- Where required by law, this product must be installed by a qualified individual.
- To prevent any possibility of electrical shocks, the power supply must be turned off before handling the heating cables.
- This product must be installed with a ground fault protection device, in compliance with the Canadian Electrical Code (CSA C22.1 Section 10) and the National Electrical Code.
- Reinforcing bars, wire mesh and other conducting material used for support or on which heating cables are installed, must be grounded, in compliance with the Canadian Electrical Code (CSA C22.1 Section 10) and the National Electrical Code.
- Heating cables must be used for outdoor applications only.
- Heating cables must be installed and fully embedded in concrete, asphalt, stone dust or other similar material, before the system is connected.

SAVE THESE INSTRUCTIONS

2 Product specifications and details

The snow melting system is designed exclusively for outdoor applications. The simplicity of the mat configuration makes it an ideal product for several locations: residential driveway, sidewalk, access ramp, underground parking ramps, etc.

This snow melting system is the assembly of a twin conductor heating cable held as a mat with flexible strips with 3" (76 mm) spacing between the cables. It is combined to a 50' (15 m) cold lead.

The heating cable consists of a resistance-heating element insulated with fluoropolymer having high dielectric strength and high temperature withstand ability. A metallic sheath provides additional mechanical strength and a ground path. A final polyolefin outer jacket makes it sturdier and provides corrosion protection. The hot and cold lead junction is uniquely designed to make it fool proof.

The heating cables for snow melting on mat are available in a wide range of capacities and lengths to suit your requirements.

2.1. Technical features

Features	
Type	Series heating cable set, twin conductor
Voltage	240/208V, 600V
Mat width	24" (610 mm) and 36" (914 mm)
Linear density	12W/ft. (39W/m)
Density (3" [76 mm] spacing)	50W/sq. ft. (538W/sq. m) at 240V and 600V, 37.5W/sq. ft. (404W/sq. m) at 208V
Covered surface	9.5 sq. ft. (0.9 sq. m) to 130 sq. ft. (12.1 sq. m)
Cold lead length	50' (15 m)
Cold lead outer diameter	3/8" (9.5 mm)
Cold lead gauge	12 AWG or 14 AWG (according to maximum allowable load)
Minimum bend radius	1" (25 mm)
Heating cable diameter	1/4" (7 mm)
Resistance wire insulation	Fluoropolymer/XLPE 0.019" (0.5 mm) thick
Outer sheath insulation	Polyolefin (EPR) 0.08" (2 mm) thick
Cold lead outer sheath insulation	PVC 0.03" (0.76 mm) thick
Ground	Copper shielding (0.823 sq. mm)
Maximum long-term exposure temperature	105 °C (221 °F)
Maximum exposure temperature for 10 minutes	220 °C (428 °F)
Minimum installation temperature	-5 °C (23 °F)
Certification	
Marking	Canada: WS, X ¹ United States: Type C

Figure 1: Cable cross-section



¹ For outdoor embedded applications.

3 Heating cable insulation and electrical resistance tests

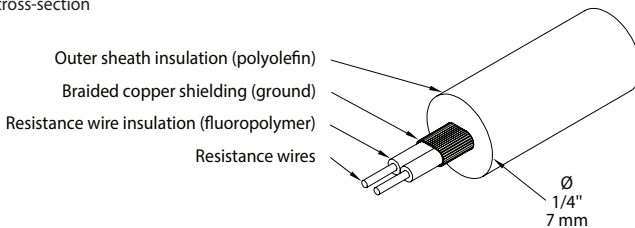
CAUTION!

Dangerous test. Measurements must be taken by a qualified electrician.

- Perform all six (6) insulation and resistance test steps² required during installation:
 1. Before breaking the security seal and opening the product.
Note: *Once the seal is broken, you are then in charge of the cable integrity throughout the entire installation process. Be sure to follow instructions and observe all precautionary measures.*
 2. After the installation of the heating cable.
 3. Before embedding the heating cable.
 4. After embedding the heating cable.
 5. After the final installation of coating (for installations under asphalt and paving only).
 6. Before connecting the heating cable system.
- Enter results in the measurement table found in the envelope.
- Affix the measurement table to the electrical panel, once completed.

Insulation test

- Only use a calibrated megohmmeter.
- Measure the insulation resistance at the free end of the cold lead, between the conductor and the ground wire.
- Enter the value measured in the measurement table.
- The value should be greater than 1,000,000 ohms.
- If the value is inferior to 1,000,000 ohms, postpone the work and contact the manufacturer's technical support.

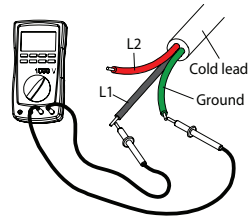

Resistance test

- Only use a calibrated multimeter.
- Measure the resistance at the free end of the cold lead, between both conductors.
- Enter the value measured in the measurement table.
- Check the integrity of the heating cable by comparing the value measured with the value specified on the cold lead cable.
- If the value measured is null or very different from the resistance rating at any stage of the installation, postpone the work and contact the manufacturer's technical support.

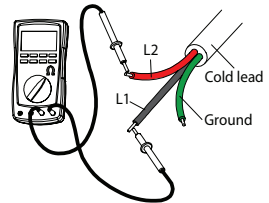

CAUTION!

For the warranty to be applicable, you must fill the measurement table and ensure that 6 measurements² have been correctly recorded.

² 5 stages for installation in a concrete slab and concrete stairs.

4 Construction planning

Installation of the heating cable system for snow melting is only one step in the construction of a surface to be heated. It is therefore important that all trade professionals involved in the various construction steps be informed of the heating cable system installation instructions and made aware of precautions to be taken throughout the entire project.

The quality of the coating material and granular base must be compliant with construction standards. All work must be done according to good engineering practices so as to ensure the long-term structural stability of the surface to be heated. Settling, cracking or crumbling of the coating could damage the cable.

Improper installation that could result in a breakage or malfunctioning of the cable will not be covered by the warranty.

CAUTION!

***Damaged cables may cause an electrical arc or fire.
Do not energize a damaged cable.***

Work stages should be planned so the cable does not remain uncovered between the installation and the coating stages. If the project encounters any delay between these stages, special precautions should be taken to mechanically protect the cable against any breakage.

Installation photographs should be taken before embedding the heating cable. They will serve as a reminder for the installation of any future elements and the detection of any breakage.

CAUTION!



***Do not roll over uncovered cables with any equipment.
Special precautions should be taken while walking over the cable
and while handling sharp tools during the installation process.***

4.1. Installation plan

A detailed installation plan that takes into account all project specifications and installation requirements (see Sections 5 and 6) should be drawn up before installing the heating cable system for snow melting.

Be sure you are familiar with the following information and ensure all elements are included in your installation plan:

- Supply voltage of system.
- Precise measurements of surface to be heated.
- Position and dimensions of elements to be bypassed.
Note: Also plan for future elements that could be added afterwards (ex: handrails, lampposts, etc...).
- The type of coating the heating cable will be embedded in: concrete, asphalt or stone dust under paving.
- The position of control joints, construction joints and expansion joints. The heating cable should not cross any expansion joints (see Section 6.1).
- Installation or not of curbs in an asphalt application.
- Position and dimensions of drain to collect and evacuate melted snow and ice.
- Position of junction boxes.
- Position of controller and sensor.

In order to know precisely the measurement of the surface to be heated, calculate the total area and subtract all clearance areas. Choose nearest suitable cable from the available range. When calculated size required is between two sizes of offered cables, select the smallest of the two. Combine multiple cables if necessary.



Need help to optimize your work plan? Contact our technical support. Clearly indicate all dimensions. A minimum of one horizontal and one vertical dimensions are necessary to validate the scale.

CAUTION!



Never cut or shorten the heating cable.

4.2. Required materials

To install your heating cable system for snow melting, you will need the following material:

Materials provided by the manufacturer

- Heating cable for snow melting on mat.
- Instruction manual.
- Measurement table label.

Required material (not provided)

- Calibrated megohmmeter and multimeter.
- Control device (available at the manufacturer).
- Ground fault circuit interrupter (GFCI).
- Junction box approved for the environment in which it is used.
- Conduit approved for cold leads (high voltage electric cable).
- Conduit approved for ground sensor³ (where required).
Note: *Conduits could be of the same type; however, cold lead and ground sensor cable should be in separate conduits.*
- Welded wire mesh or reinforcing bars for installation in concrete slabs.
- Plastic tie-wraps for framework installations (plastic tie-wraps are available at the manufacturer as an option).
- Concrete anchors or nails to set the galvanized steel strapping (strapping available at the manufacturer as an option).
- Angle irons, 1" x 1" (protection of cable under control joints for a concrete slab installation).
- RTV silicone rubber (protection of cable under control joints for a concrete slab installation and to seal the ground sensor).
- Measuring and leveling tools.
- Scissors.
- Spray paint to outline clearances.

³ Diameter of the ground sensor cable: 5/16" (8 mm).

5 General installation guidelines

Unless otherwise specified, guidelines specified in this section apply, regardless of the type of coating used for embedding the heating cable.

Please review installation guidelines before starting the installation. Be sure to adhere to all construction codes and regulations applicable in your area.

5.1. Preparation of foundation

- The heating cable system for snow melting should be installed on a foundation capable of withstanding environmental conditions as intended for the application while also providing a long-term structural stability.
- The granular foundation should allow for adequate drainage of melting snow and ice. Provide an additional drain where necessary.

Note: Thermal insulation is not required but could improve the performance and energy efficiency of the snow melting system. Consult with an architect or engineer to ensure the structural integrity of the thermal insulation and its appropriate location. The cable should not come into contact with thermal insulation.

5.2. Equipment verification

- Be sure the heating cable power output is sufficient for the area to be heated.
- Be sure the heating cable rated voltage is equivalent to the system's rated voltage. Never connect a product designed for 208/240V to 347V.
- Perform all insulation and resistance tests before breaking the integrity seal and enter results in the measurement table.
- Connect the electrical fault indicator to the free end of the cold lead to ensure the integrity of the heating cable throughout the entire construction period. Reconnect the electrical fault indicator to the cold lead after each test phase.

CAUTION!

**Never cut or shorten the heating cable.
Never connect a product designed for 208/240V to 347V.**

CAUTION!

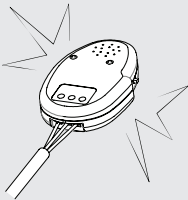

If the electric fault indicator sounds during installation or embedding procedures, mark the location where the cable was damaged. Delineate an area of at least 2 sq. ft. (0.2 sq. m) around the damaged section of the cable and do not cover that area. Proceed with the installation. Repair the cable with the repair kit. If you need assistance with the repair, contact the manufacturer's technical support.

5.3. Clearance and bypass distances

- Install heating cables at a minimum distance of 6" (152 mm) from the edge of the surface to be heated or from an exterior wall.
Note: For embedding in asphalt (without curbs), install the heating cable at 12" (305 mm) from the edge.
- Install heating cables at a minimum distance of 6" (152 mm) from fixed elements.
Note: Plan for future elements which could be added afterwards (handrails, lampposts, etc...).
- Always maintain a minimum distance of 3" (76 mm) between heating cables.
- Install heating cables at a minimum distance of 0.5" (13 mm) from any uncovered combustible surface.
- To change directions or bypass obstacles, cut flexible strips and rotate the mat.
- To adjust cables to a smaller surface than the width of the mat, detach a suitable section of cable length from the flexible strips to cover the surface to be heated.
- If the cable must cover a distance greater than 10 ft. (3 m), a U-shaped loop must be used to minimize conductor thermal expansion and prevent it from breaking, while respecting the minimum bending radius of the cable.

CAUTION!



Never cross, overlap or bundle cables.

Figure 2: Cable configuration and clearances

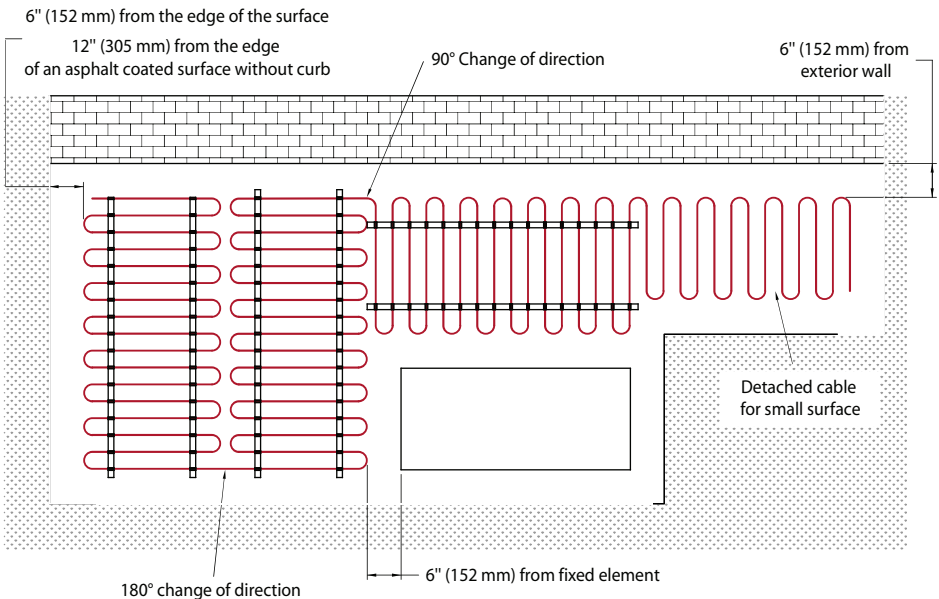

5.4. Anchoring heating cable to foundation base

For applications where the mat or detached cable must be anchored to a solid foundation base such as asphalt coating or concrete stairs, use galvanized steel strapping (available as an option, sold separately).

- Strapping must be installed perpendicular to the cable.
- Install two rows of strapping 18" (457 mm) apart for 24" (610 mm) wide models and 30" (762 mm) apart for 36" (914 mm) wide models.
- For detached cable, maintain a minimum space of 36" (914 mm) to 48" (1219 mm) between strapping.
- Firmly anchor strapping to the foundation base using concrete anchors or nails.
- Attach the cable to the strapping (see figure 4). Do not fasten cables too tightly to avoid any damage. Cable should have some slack.

CAUTION!

Maintain a minimum spacing of 3" (76 mm) between cables.

Figure 3: Position of strapping

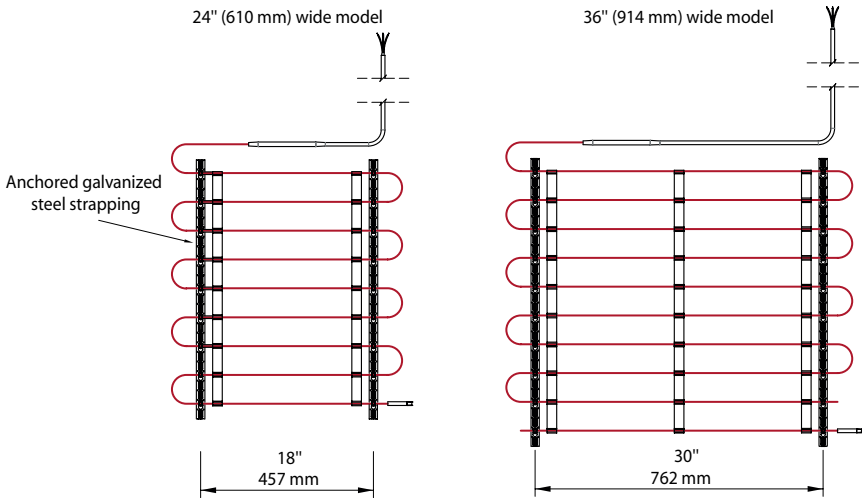
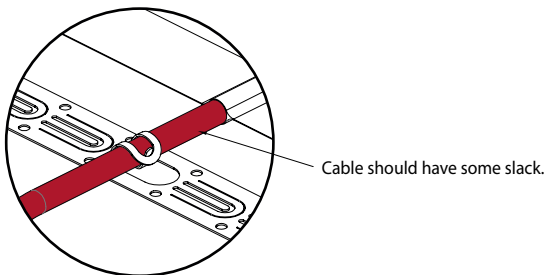

Figure 4: Strapping fastening method



5.5. Installation of ground sensor conduit⁴

Where heating cables are connected to an electric controller, a ground sensor must be installed to detect humidity and temperature.

For more information, please follow the manufacturer's instructions supplied with the product.

- Install a conduit approved for ground sensor cable, at the same stage as installing the cold lead conduit, as specified in installation guidelines (see Section 6).
Note: *The ground sensor cable should be inserted in a separate conduit than that of the cold lead. For asphalt coating, make sure the conduit can withstand hot asphalt.*
- Run the conduit between two heating cables. Do not cross, overlap or bundle the heating cables and the ground sensor conduit.
- Position the ground sensor inside the heated surface, in an open location that will be subject to precipitations.
- If the ground sensor is installed on a slope, be sure to position the sensor so the top part is horizontal.
- Ground sensors should be installed once the surface coating has been laid.

Figure 5: Position of ground sensor

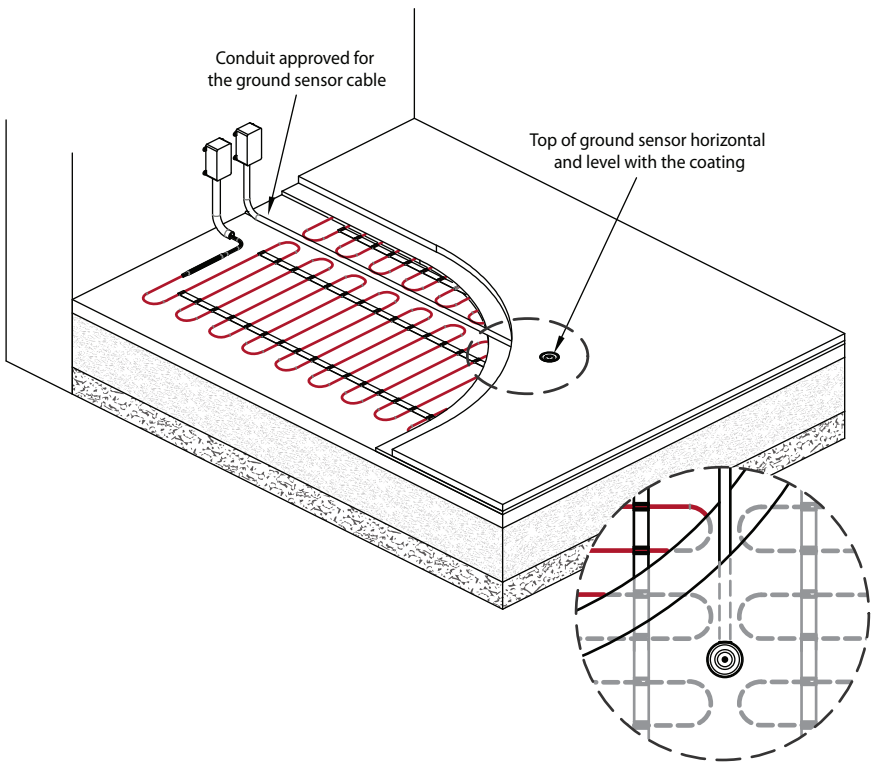

⁴Refer to the product catalogue for more information on available products.
Each option is supplied with an installation manual.

6 Installation guidelines per type of coating

Guidelines specified in this section are specially formulated for each type of coating. Be sure to conform to minimum and maximum embedding and coating thickness specifications to ensure optimum system performance. Review all guidelines before you begin. Be sure to adhere to all construction codes and regulations applicable in your area.

6.1. Concrete slab (one pour)

- Be sure to have the site cleared of any sharp objects that could damage cables during the installation process.
- Install the welded wire mesh or reinforcing bars so the upper part of the cable is at a minimum distance of 2" (50 mm), and maximum distance of 3.5" (89 mm) from the finished surface of the coating.

The concrete slab should be adequately reinforced to ensure its integrity. Settling, cracking or crumbling of the coating could damage the cable.

The concrete slab should have a minimum thickness of 6" (152 mm) when used for vehicles or 4" (101 mm) when there are no vehicles being used on it.

- Use enough levelling pads to maintain a uniform depth for embedding the heating cable. Be sure not to apply any excessive pressure by walking on the cable.
- Indicate, with spray paint, the position of fixed elements, expansion and control joints to be bypassed.
Note: *Also plan for future elements that could be added afterwards.*
- Install the cold lead conduit at the planned location. The opening of the conduit should be embedded.
Note: *Cold lead and ground sensor conduits must be separated by a minimum of 6" (152 mm) where exiting the heated surface.*
- Insert the cold lead in the conduit.
Note: *The cold lead can be shortened if needed. Be sure to leave the nameplate near the connection.*
- Keep the end of the cold lead dry and protected throughout the entire installation process.
- Place the mechanical joint between the cold lead and heating cable at a minimum of 6" (152 mm) inside the surface to be heated. The mechanical joint should be entirely embedded. The conduit must protect the cold lead all the way inside (3" (76 mm)) the surface to be heated. The exit point of the conduit must be completely embedded. Never bend the mechanical joint. Never insert the mechanical joint or any part of the heating cable inside the conduit.
- Unroll the mat as specified in the installation plan.
- Attach the cable to the framework using plastic tie-wraps. Do not use metal tie-wraps. Be sure to firmly anchor the mat to the framework to prevent any movement when pouring the concrete.
Note: *Conform to clearances during the entire installation process (see section 5.3).*
- Install the heating cable at a minimum distance of 3" (76 mm) and maximum distance of 6" (152 mm) from the expansion joint. The heating cable should not cross an expansion joint.
Note: *Where it is not possible to avoid crossing an expansion joint, bypass the joint by routing the heating cable under the slab (see figure 7).*
- Where the construction of the surface to be heated requires a sawn joint, protect the cable where it crosses the control joints (see figure 8). Limit the number of locations where the cable crosses the control joint. The control joint should not exceed a maximum depth of 1" (25 mm).
- Perform insulation and resistance tests after the installation of the cable and before pouring the concrete. Enter results in the measurement table.
- Proceed with the pour. Be sure not to move the cable while the concrete is being poured.
- Perform the insulation and resistance tests after the concrete is poured and enter results in the measurement table.
- Be sure to conform to the curing period of the coating as specified by the manufacturer, before powering up the system.

CAUTION!



Do not roll over uncovered cables with any equipment. Special precautions should be taken while walking over the cable and while handling sharp tools during the installation process.

CAUTION!

Work stages should be planned so the cable does not remain uncovered between the installation and the coating stages. Where the project encounters any delay between these stages, special precautions should be taken to mechanically protect the cable against any breakage.

Figure 6: Concrete coating

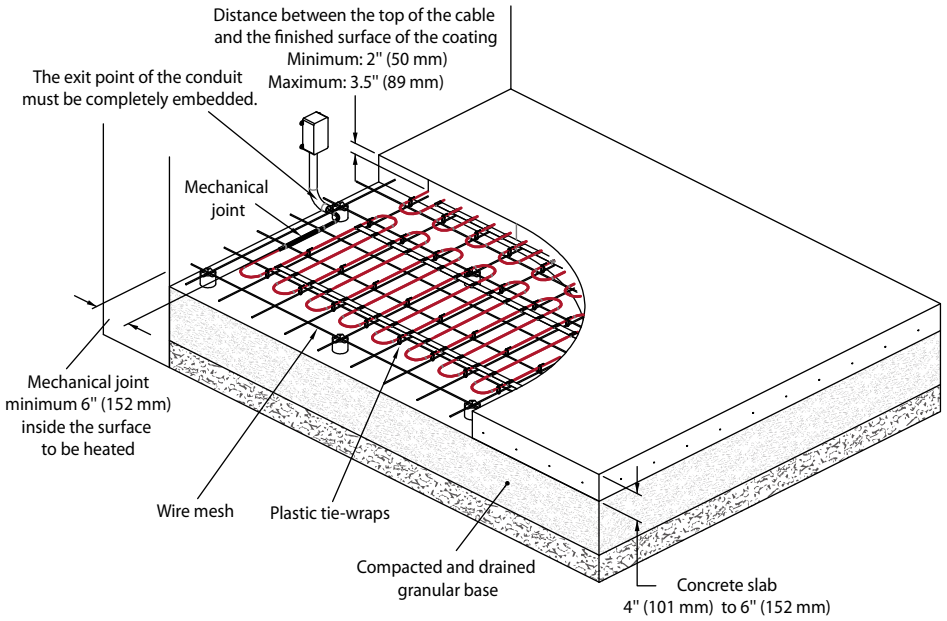

Figure 7: Bypass of expansion joint

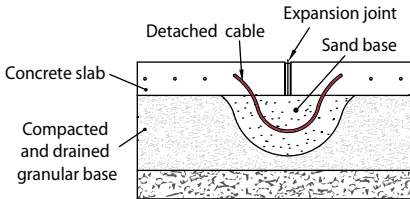
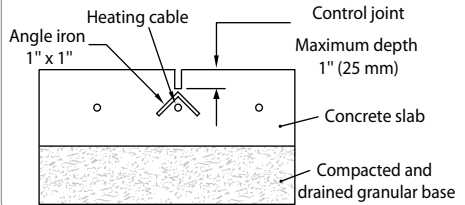

Figure 8: Crossing a control joint



6.2. Asphalt

6.2.1. Double pour

- Be sure to have the site cleared of any sharp objects that could damage cables during the installation process.
- Lay a base layer of asphalt over the granular base a minimum thickness of 2" (50 mm) after compaction. It should be sufficiently thick to support the intended loads. Let the base coat set. Do not install cables directly on the granular base.
- Indicate, with spray paint, the position of fixed elements to be bypassed.
Note: *Also plan for future elements that could be added afterwards.*
- Install the cold lead conduit at the planned location. The opening of the conduit should be embedded. The conduit should be capable of withstanding hot asphalt.
Note: *Cold lead and ground sensor conduits must be separated by a minimum of 6" (152 mm) where exiting the heated surface.*
- Insert the cold lead in the conduit.
Note: *The cold lead can be shortened if needed. Be sure to leave the nameplate near the connection.*
- Keep the end of the cold lead dry and protected throughout the entire installation process.
- Place the mechanical joint between the cold lead and heating cable at a minimum of 6" (152 mm) inside the surface to be heated. The mechanical joint should be entirely embedded. The conduit must protect the cold lead all the way inside the surface to be heated. The exit point of the conduit must be completely embedded. Never bend the mechanical joint. Never insert the mechanical joint or any part of the heating cable inside the conduit.
- Unroll the mat as specified in the installation plan.
- Attach the mat to the base layer using galvanized steel strapping (see section 5.4). Be sure to firmly anchor the mat to the base layer to prevent any movement when embedding.
Note: *Conform to clearances during the entire installation process (see section 5.3).*
- Perform insulation and resistance tests after the installation of the cable and before the manually applied coat. Enter results in the measurement table.
- Manually cover the heating cable with a layer of asphalt a minimum thickness of 0.5" (13 mm) after compaction. Use a roller compacter (maximum 1.5 ton).
- Lay an asphalt wearing course a minimum thickness of 1.5" (38 mm), maximum 3" (89 mm), after compaction. Only use pneumatic equipment.
- Perform insulation and resistance tests after the laying of the asphalt wearing course is complete and cold and enter results in the measurement table.
Note: *Resistance value may have changed slightly due to asphalt temperature.*
- Be sure to conform to the curing period of the coating as specified by the manufacturer, before powering up the system.

CAUTION!



Do not roll over uncovered cables with any equipment. Special precautions should be taken while walking over the cable and while handling sharp tools during the installation process.

CAUTION!

Work stages should be planned so the cable does not remain uncovered between the installation and the coating stages. Where the project encounters any delay between these stages, special precautions should be taken to mechanically protect the cable against any breakage.

Figure 9: Double pour asphalt coating

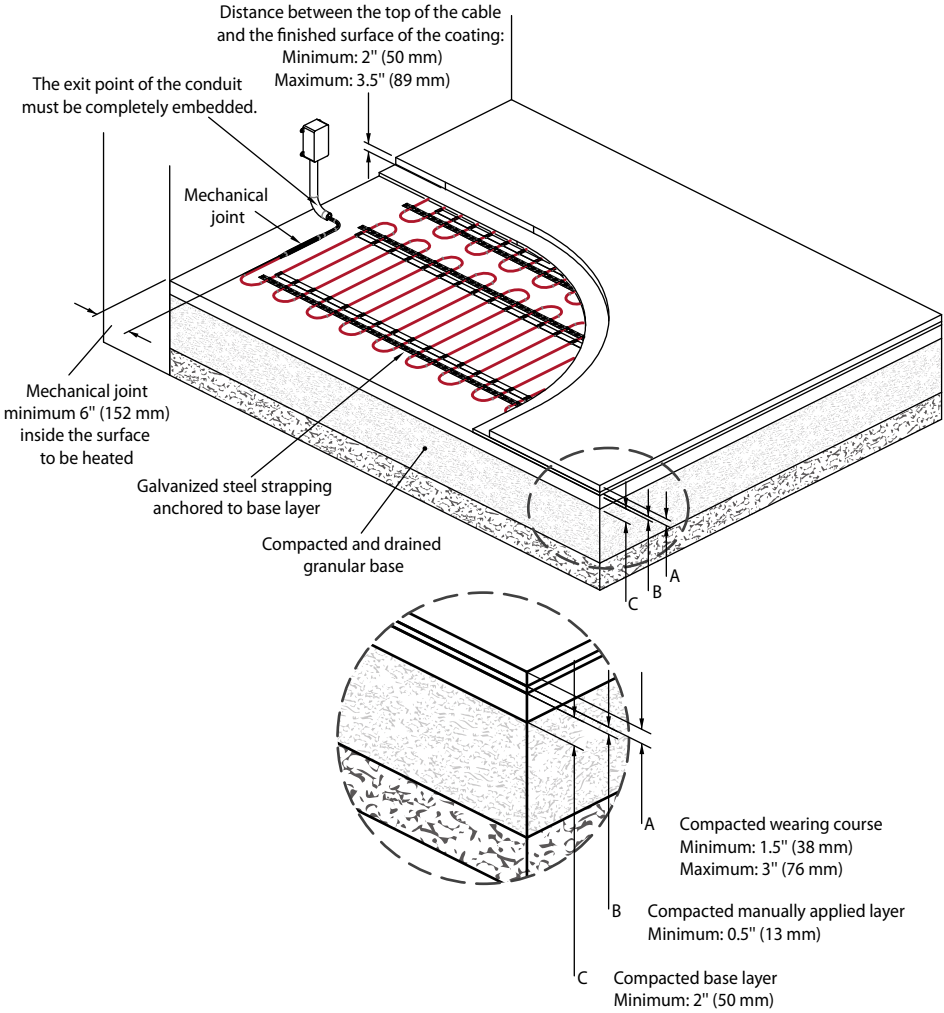

6.2.2. Single pour (heating cables embedded in stone dust)

- Be sure to have the site cleared of any sharp objects that could damage cables during the installation process.
- Lay the first layer of stone dust over the granular base a minimum thickness of 1" (25 mm). Do not install cables directly on the granular base.
- Indicate, with spray paint, the position of fixed elements to be bypassed.
Note: Also plan for future elements that could be added afterwards.
- Install the cold lead conduit at the planned location. The opening of the conduit should be embedded. The conduit should be capable of withstanding hot asphalt.
Note: Cold lead and ground sensor conduits must be separated by a minimum of 6" (152 mm) where exiting the heated surface.
- Insert the cold lead in the conduit.
Note: The cold lead can be shortened if needed. Be sure to leave the nameplate near the connection.
- Keep the end of the cold lead dry and protected throughout the entire installation process.
- Place the mechanical joint between the cold lead and heating cable at a minimum of 6" (152 mm) inside the surface to be heated. The mechanical joint should be entirely embedded. The conduit must protect the cold lead all the way inside the surface to be heated. The exit point of the conduit must be completely embedded. Never bend the mechanical joint. Never insert the mechanical joint or any part of the heating cable inside the conduit.
- Unroll the mat as specified in the installation plan.
- Attach the mat to the base layer using galvanized steel strapping (see section 5.4). Be sure to firmly anchor the mat to the base layer to prevent any movement when embedding.
Note: Conform to clearances during the entire installation process (see section 5.3).
- Perform insulation and resistance tests after the installation of the cable and before laying the second coat of stone dust. Enter results in the measurement table.
- Lay a second layer of stone dust over the heating cable a minimum thickness of 1" (25 mm). Be sure not to move the cable during the second application of stone dust.
- Lay the asphalt wearing course a minimum thickness of 1.5" (38 mm), maximum 3" (89 mm), after compaction. Only use pneumatic equipment.
- Perform insulation and resistance tests after the laying of the asphalt wearing course is complete and enter results in the measurement table.
Note: Resistance value may have changed slightly due to asphalt temperature.
- Be sure to conform to the curing period of the coating as specified by the manufacturer, before powering up the system.

CAUTION!



Do not roll over uncovered cables with any equipment. Special precautions should be taken while walking over the cable and while handling sharp tools during the installation process.

CAUTION!

Work stages should be planned so the cable does not remain uncovered between the installation and the coating stages. Where the project encounters any delay between these stages, special precautions should be taken to mechanically protect the cable against any breakage.

Figure 10: Single pour asphalt coating (heating cables embedded in stone dust)

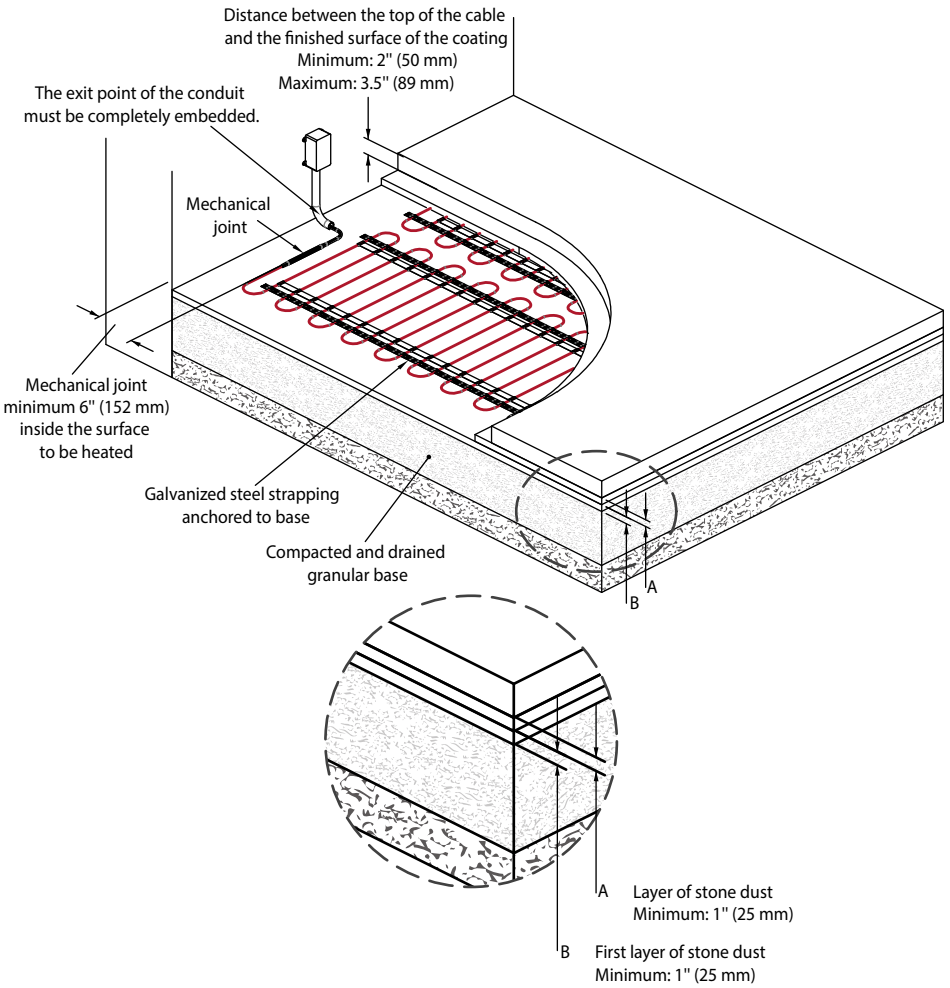

6.3. Brick, concrete or natural stone paving

- Be sure to have the site cleared of any sharp objects that could damage cables during the installation process.
- Lay the first layer of stone dust over the granular base a minimum thickness of 1" (25 mm). Do not install the cable directly over the granular base.
- Indicate, with spray paint, the position of fixed elements to be bypassed.
Note: *Also plan for future elements that could be added afterwards.*
- Install the cold lead conduit at the planned location. The opening of the conduit should be embedded.
Note: *Cold lead and ground sensor conduits must be separated by a minimum of 6" (152 mm) where exiting the heated surface.*
- Insert the cold lead in the conduit.
Note: *The cold lead can be shortened if needed. Be sure to leave the nameplate near the connection.*
- Keep the end of the cold lead dry and protected, throughout the entire installation process.
- Place the mechanical joint between the cold lead and heating cable at a minimum of 6" (152 mm) inside the surface to be heated. The mechanical joint should be entirely embedded. The conduit must protect the cold lead all the way inside the surface to be heated. The exit point of the conduit must be completely embedded. Never bend the mechanical joint. Never insert the mechanical joint or any part of the heating cable inside the conduit.
- Unroll the mat as specified in the installation plan.
- Attach the mat to the base layer using galvanized steel templates (see section 5.4). Be sure to firmly anchor the mat to the framework to prevent any movement when embedding.
Note: *Conform to clearances during the entire installation process (see section 5.3).*
- Perform insulation and resistance tests after the installation of the cable and before laying the second coat of stone dust. Enter results in the measurement table.
- Lay a second layer of stone dust over the heating cable a minimum thickness of 1" (25 mm). Be sure not to move the cable during the second application of stone dust.
- Install paving and stabilize the installation using a plate compactor. Fill all joints in compliance with the manufacturer's recommendations.
- Perform insulation and resistance tests after the laying of paving is complete and enter results in the measurement table.

CAUTION!



Do not roll over uncovered cables with any equipment. Special precautions should be taken while walking over the cable and while handling sharp tools during the installation process.

CAUTION!

Work stages should be planned so the cable does not remain uncovered between the installation and the coating stages. Where the project encounters any delay between these stages, special precautions should be taken to mechanically protect the cable against any breakage.

Figure 11: Brick, concrete or natural stone paving

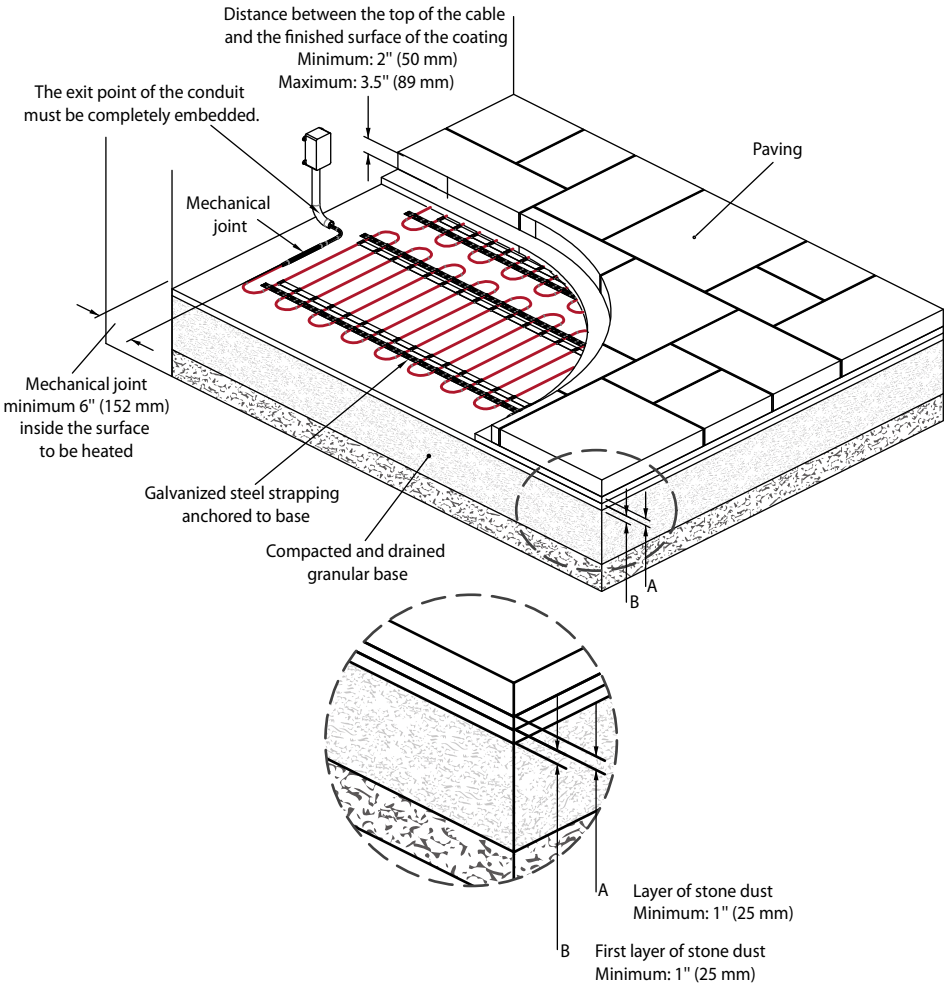

6.4. Concrete stairs (two pours)

- Be sure to have the site cleared of any sharp objects that could damage cables during the installation process.
- Calculate the dimensions for the first pour so the top of the cable is located at a minimum distance of 2" (50 mm), and maximum distance of 3.5" (89 mm) from the finished surface of the stairs.
- Proceed with the first pour. Let the concrete set. Remove all forms to clear the surface of the riser.
- The concrete stairs should be adequately reinforced to ensure their integrity. Settling, cracking or crumbling of the coating could damage the cable.
- Round off the step nosing where the cable will run.
- Indicate, with spray paint, the position of fixed elements to be bypassed.
Note: *Also plan for future elements that could be added afterwards.*
- Install the cold lead conduit at the planned location. The opening of the conduit should be embedded.
- **Note:** *Cold lead and ground sensor conduits must be separated by a minimum of 6" (152 mm) where exiting the heated surface.*
- Insert the cold lead into the conduit.
Note: *The cold lead can be shortened if needed. Be sure to leave the nameplate near the connection.*
- Keep the end of the cold lead dry and protected, throughout the entire installation process.
- Place the mechanical joint between the cold lead and heating cable at a minimum of 6" (152 mm) inside the surface to be heated. The mechanical joint should be entirely embedded. The conduit must protect the cold lead all the way inside the surface to be heated. The exit point of the conduit must be completely embedded. Never bend the mechanical joint. Never insert the mechanical joint or any part of the heating cable inside the conduit.
- Unroll the mat as specified in the installation plan. Where the construction of the mat does not allow to conform to the necessary clearances, (see Figure 12), detach the cable from the flexible strips.
- Attach the mat to the base layer using galvanized steel strapping (see Section 5.4). Be sure to firmly anchor the mat to the base layer to prevent any movement when embedding.
Note: *Conform to clearances during the entire installation process (see Section 5.3).*
- Perform insulation and resistance tests after the concrete is poured and enter results in the measurement table.
- Proceed with the second pour. Use an appropriate method to prepare the surface before the second pour is done and be sure adherence is adequate between the two layers. Delaminating of concrete layers could damage the cable. Be sure not to move the cable during the pouring process.
- Perform insulation and resistance tests after the installation of the cable and before pouring the concrete. Enter results in the measurement table.
- Be sure to conform to the curing period of the coating as specified by the manufacturer before powering up the system.

CAUTION!



Do not roll over uncovered cables with any equipment. Special precautions should be taken while walking over the cable and while handling sharp tools during the installation process.

CAUTION!

Work stages should be planned so the cable does not remain uncovered between the installation and the coating stages. Where the project encounters any delay between these stages, special precautions should be taken to mechanically protect the cable against any breakage.

Figure 12: Concrete stairs

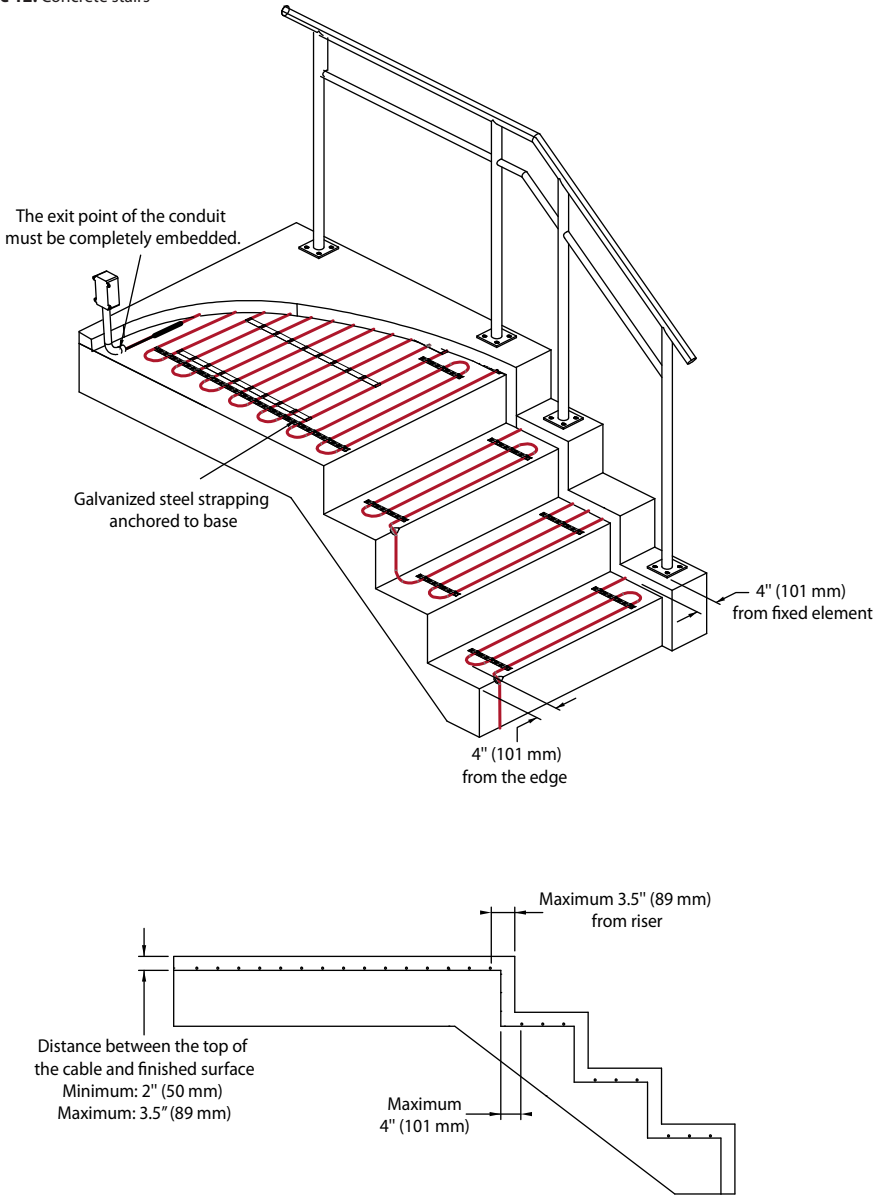

7 Electrical connection

CAUTION!

Electrical connection should be performed by a master electrician.

CAUTION!

System connection should be performed once the heating cable is completely embedded and the curing period for coatings is complete. Follow the manufacturer's recommendations.

CAUTION!

This product must be installed with a ground fault protection device, in compliance with the Canadian Electrical Code (CSA C22.1 Section 10) and the National Electrical Code.

- Perform insulation and resistance tests before connecting the system to the controller and enter results in the measurement table.
- Follow the controller manufacturer's instructions for connecting the heating cable system. Instructions are part of your product packaging.
- We strongly recommend using the manufacturer thermostats.
- If other thermostats/ controls are used, make sure they are double pole, i.e. they cut off both power lines to the cable(s).
- If code allows it, we recommend using a ground fault protection device that can be adjusted up to 30mA.

Note: *If you need assistance with the connection of your heating cable system for snow melting, please contact the manufacturer's technical support.*

