

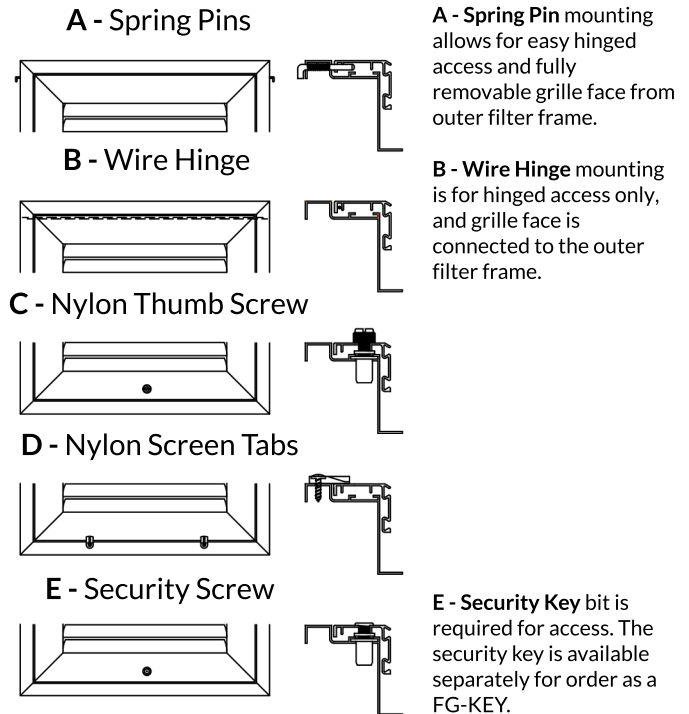

- Horizontal blades fixed on 30° deflection with 2/3" spacing.
- Aluminum roll-formed blade pressure fitted for rattle free performance.
- Designed to fit a standard 2" filter depth.
- High quality aluminum extruded frames.
- Mullions used for sizes over 22" in length.
- Available on 2" increments as standard. Custom sizes available down to 1/16" increments.
- Available with durable powder coat finish.

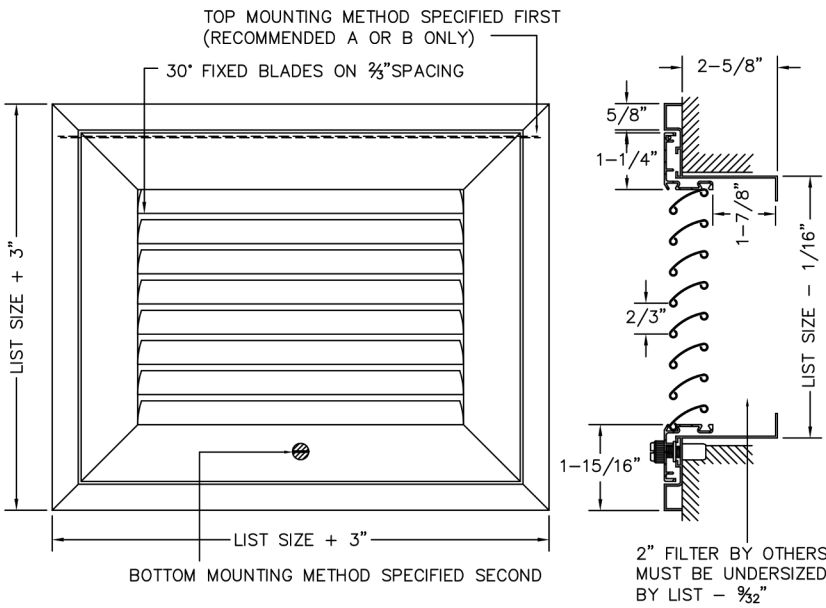

1. Select a Top Mounting Option

- A - Spring Pins
- B - Wire Hinge
- C - Nylon Thumb Screw
- D - Nylon Screen Tabs
- E - Security Screw

2. Select a Bottom Mounting Option

- A - Spring Pins
- B - Wire Hinge
- C - Nylon Thumb Screw
- D - Nylon Screen Tabs
- E - Security Screw

3. Specify the Length x Height Dimensions

Inches MM _____ x _____

4. Select a Finish

- W - White
- S - Silver
- M - Mill

5. Select a Lead Time

- 3 Day Ship
- Next Friday
- Standard Delivery



Additional Options

- D - Opposed Blade Damper

Project / Location: _____
Architect: _____
Engineer: _____
Contractor: _____

