

## DAF | Floor Bar Linear Grille

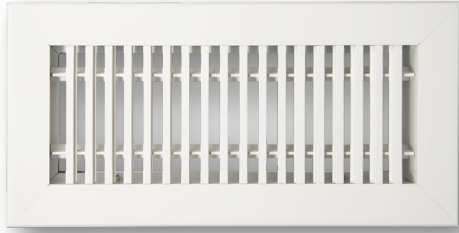

- Fully extruded, high quality aluminum construction for a stylish appearance.
- Blade deflection transitions from 0°, 15° and 30° for wider air distribution.
- Reinforced core designed for floor applications.
- Fixed blades parallel to the long dimension.
- Lengths available on 1/2" increments as standard. Custom sizes available down to 1/16" increments.
- Available with durable powder coat finish.

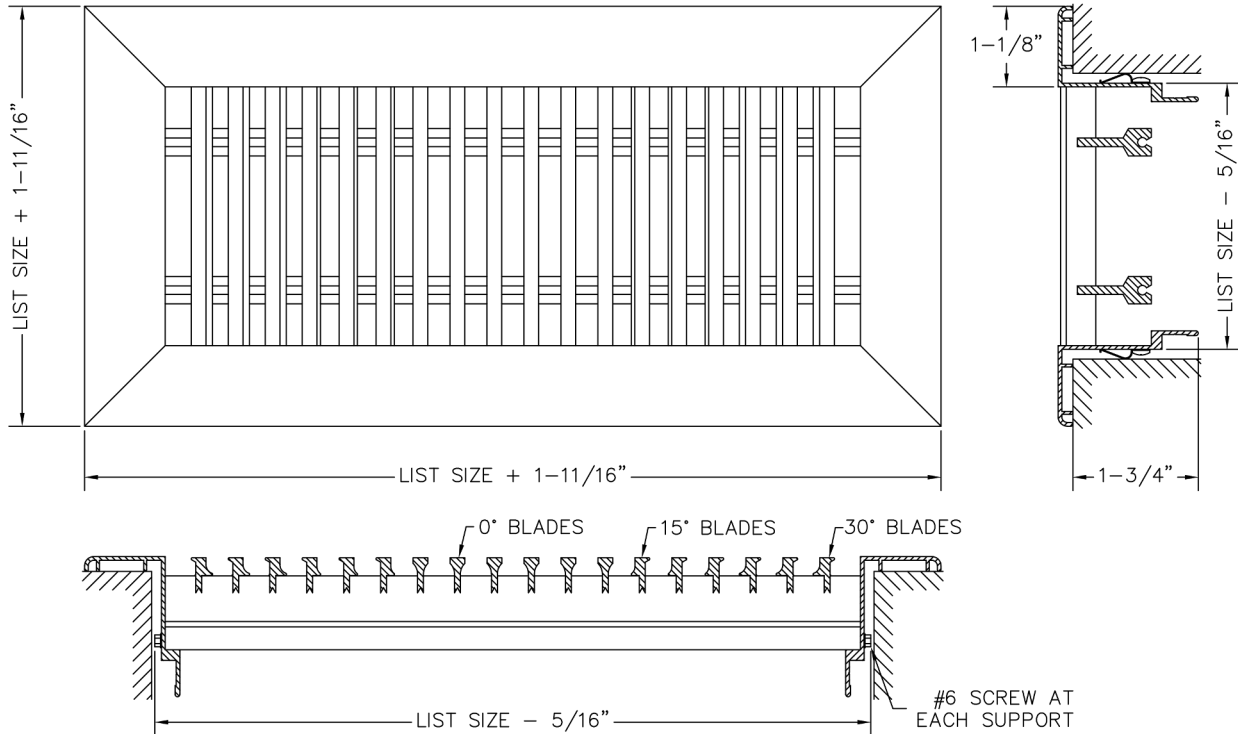

1. Specify a Length  
(3" - 8")

Inches  MM

2. Select a Height

- 8"
- 10"
- 12"
- 14"
- 16"
- 18"

3. Select a Finish

- W - White
- S - Silver
- B - Brown
- M - Mill
- FB - Flat Black
- Special:

Updated - More sizes  
now available!

**3 DAY  
SHIP**  
ANY SIZE. ANY MODEL.  
GUARANTEED

**Additional Option**

See specific submittal pages for option listed below.

- D - Opposed Blade Damper

4. Select a Lead Time

- 3 Day Ship
- Next Friday
- Standard Delivery

**Alternative Mounting Options**

B - Spring Clips are standard. Select only if an alternative mounting option is preferred:

- A - Screw Holes
- TB - No Mounting

Project / Location: \_\_\_\_\_

Architect: \_\_\_\_\_

Engineer: \_\_\_\_\_

Contractor: \_\_\_\_\_

### BLADE OPTIONS

**-00**

0° 13/64" blades on 1/2" centers

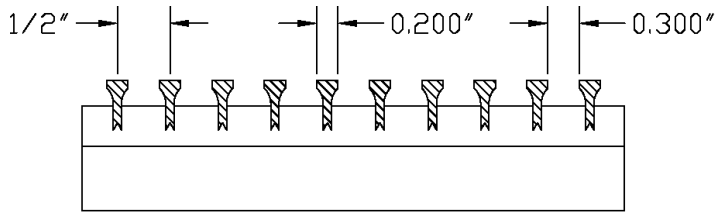

**-01**

0° 1/4" blades on 1/2" centers

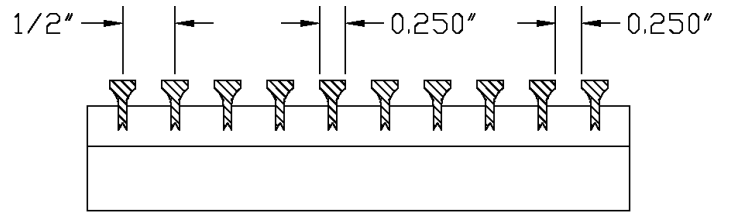

**-15**

15° 13/64" blades on 1/2" centers

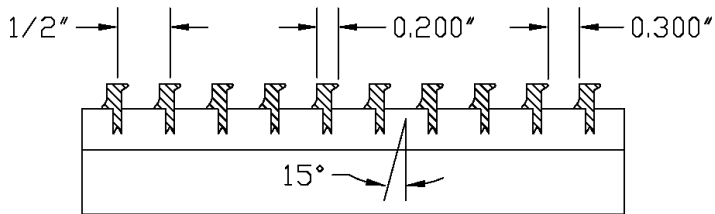

**-30**

30° 13/64" blades on 1/2" centers

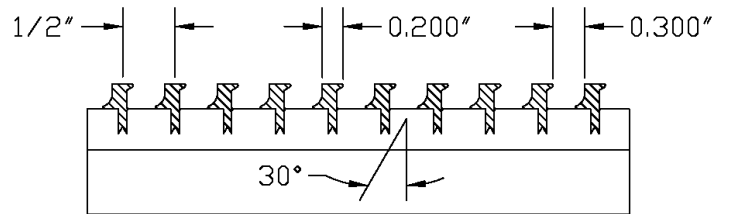

**-82**

0° 1/8" blades on 1/2" centers

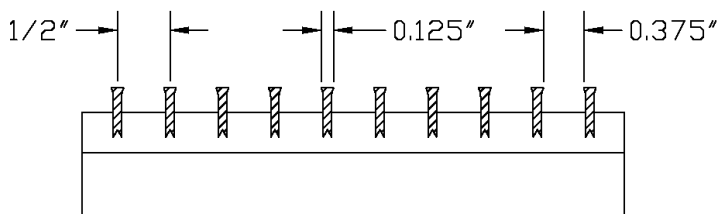

**-84**

0° 1/8" blades on 1/4" centers

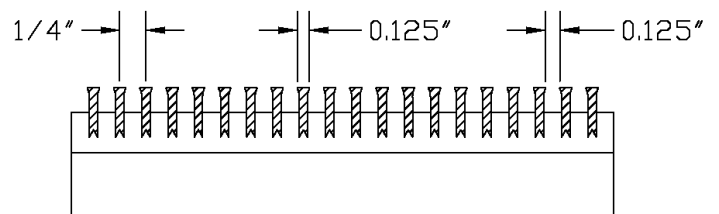

### MOUNTING

**-A**

Screw Holes

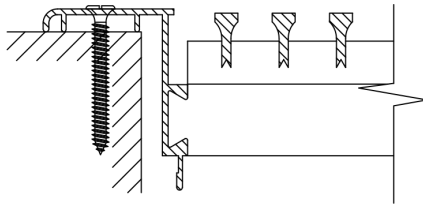

Color matched screws with countersunk screw holes.

**-B**

Spring Clips

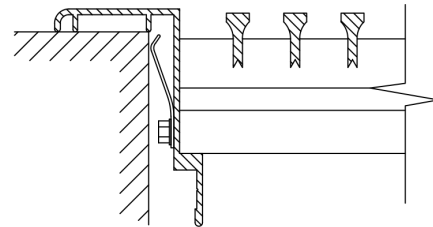

Hidden clips behind the flange to keep the grille secure in the opening. Only suitable for floor & sill applications.

**-C**

Concealed Brackets

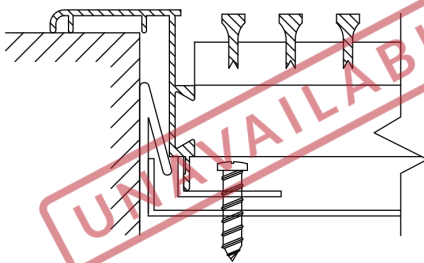

Product is fastened to duct-mounted brackets, which are concealed behind the blades.

**-D**

Sidewall Screw Holes

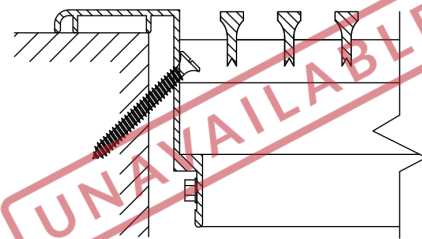

Screw holes are drilled at a 45° angle on inner flange. Only available with Removable Core.

**-TB**

No Mounting

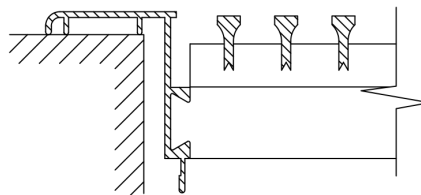

Designed for lay-in ceiling and custom applications. For lay-in, order 2" under to account for flange.

e.g. 22" x 10" will have O.D. 23-11/16" x 11-11/16" and fit a standard 24" x 12" T-bar opening.