



## Battery Backup Unit (BBU) – Submittal/Technical Data

For Series 70 Actuators — 800-5,000 lb-in.

### Battery Backup Unit - Specifications

Technical Specifications		
Power Requirements	24-27 VAC or 30-38 VDC (the minimum voltage is required to provide proper battery charging). Use dedicated Class 2 non-bonded transformer rated 100VA per BBU	
VA Requirements (Actuator w/ BBU)	All Models w/BBU	100 VA Each BBU must be wired separately to a dedicated non-bonded transformer.
Contact Ratings	Battery Strength Alarm	2 A
	All Other Contacts	See Bray Series 70 Technical Brochure
Temperature Limits	Operating	-4 to 122 °F (-20 to 50 °C)
	Battery Charging	-4 to 122 °F (-20 to 50 °C)
	Storage	-20 to 140 °F (-29 to 60 °C) <sup>1</sup>
Batteries (2)	Type	SLA (Sealed Lead Acid) Power Sonic PS1212 or Equal
	Life	4 years, depended on ambient temperature
	Charging <sup>2, 3</sup>	Continuous
	Discharging	4.2A (Only upon loss of input power)
Housing	Die Cast Aluminum, Polyester Finish, Nema 4X (IP 65)	
Wiring	Conduit Entries (2)	3/4" NPT
	Terminal Block	14 to 24 AWG. See Application Note 2.
Warranty	3 Years limited from time of shipment.	

<sup>1</sup> Leaving the battery in an unpowered state for long periods at ambient temperatures greater than 140°F will result in excessive battery drain.

<sup>2</sup> BBU batteries will NOT charge with a 24 VDC power supply. 30 VDC minimum required to charge batteries.

<sup>3</sup> 24 VAC/30 VDC minimum voltage required to charge batteries.

#### Disclaimer:

The performance specifications are nominal and conform to acceptable industry standards. For application at conditions beyond these specifications, consult the local Bray office. Bray, Inc. shall not be liable for damages resulting from misapplication or misuse of its products.

#### Operation:

In the normal mode of operation with power supplied to the actuator, the batteries maintain a charge and are in an offline mode. The power applied to the motor is from the power supply, not the batteries. When a power loss occurs, the BBU pauses for 5 seconds and then reads the "Open/Close" fail position switch setting. The BBU circuitry applies the stored power in the batteries to move the valve or damper to the full open or full closed position designated by the user. The actuator remains in this position until external power is restored to the unit.

For two position (On/Off units), and modulating units, the BBU board automatically detects when the actuator has reached the desired position and then disconnects the battery power from the motor.

#### Application Note:

1. Use Battery Backup Unit (BBU) only to control equipment under normal operating conditions. Where failure or malfunction of the electric actuator could lead to personal injury or property damage to the controlled equipment or other property, additional precautions must be designed into the control system. Incorporate and maintain other devices such as supervisory or alarm systems or safety or limit controls, intended to warn of or protect against failure or malfunction of the electric actuator.

2. Size wires per NEC guidelines with respect to distance and current draw. See wiring length vs. gauge table from BBU IOM page 4.

# Battery Backup Unit - Model Number Selection Chart

Model Number	Torque in.lbs.	On/Off	Modulating	Heater	AUX. Switches	Battery Backup Unit
70-24-0081H-BBU	800	●		●	●	●
70-24-0081SVH-BBU	800		●	●	●	●
70-24-0201H-BBU	2000	●		●	●	●
70-24-0201SVH-BBU	2000		●	●	●	●
70-24-E301H-BBU	3000	●		●	●	●
70-24-E301SVH-BBU	3000		●	●	●	●
70-24-0501H-BBU	5000	●		●	●	●
70-24-0501SVH-BBU	5000		●	●	●	●

**Note: Heaters are optional**

To receive units without a heater, remove the "H" from the part number. (Ex.: 70-0501, 70-24-0501-BBU)

**Application Note:**

Use Series 70 actuators only to control equipment under normal operating conditions. Where failure or malfunction of the electric actuator could lead to personal injury or property damage to the controlled equipment or other property, additional precautions must be designed into the control system. Incorporate and maintain other devices, such as supervisory or alarm systems or safety or limit controls, intended to warn of or protect against failure or malfunction of the electric actuator.

## Battery Backup Unit - Dimensions

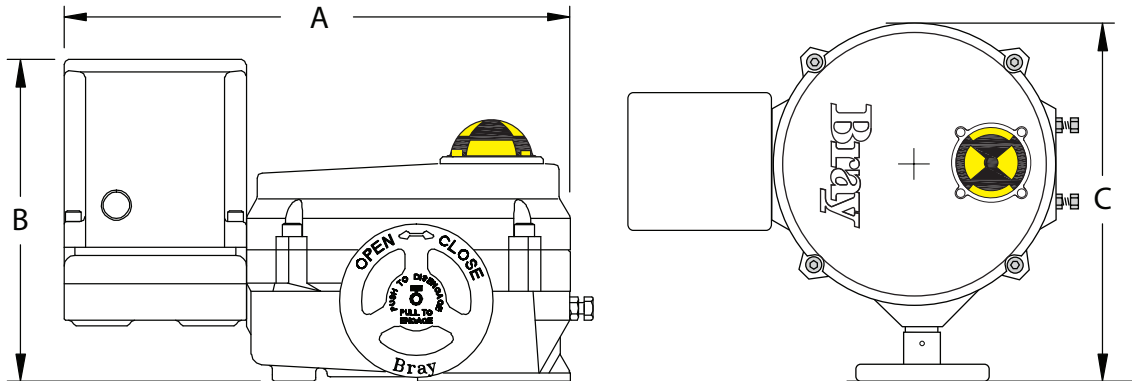

Actuator/BBU	A	B	C
70-24-0081-BBU	12.0	7.4	9.4
70-24-0201-BBU	14.5	7.9	12.9
70-24-E301-BBU	14.5	7.9	12.9
70-24-0501-BBU	16.6	8.4	13.1

All dimensions in inches.  
 Allow 5.0" for cover removal.  
 Conduit Entries (2) 3/4" NPT

# Battery Backup Unit - Wiring

## 24VAC/VDC ON/OFF NXT WITH BBU

REFERENCE WIRING DIAGRAMS: BCD-WD-A034

## 24VAC/VDC SERVO NXT WITH BBU

REFERENCE WIRING DIAGRAM: BCD-WD-A035

### FIELD WIRING

### ACTUATOR

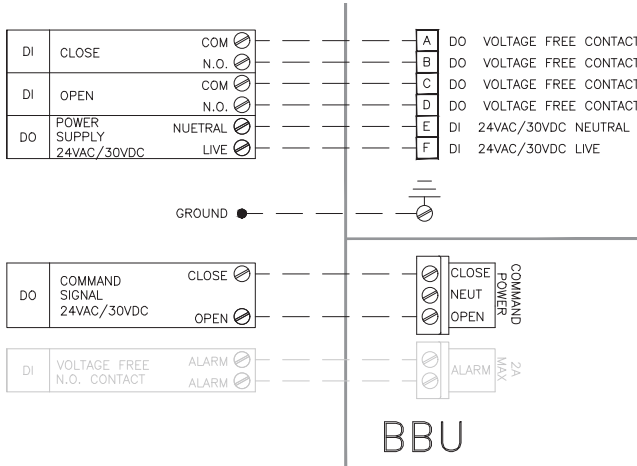

### FIELD WIRING

### ACTUATOR

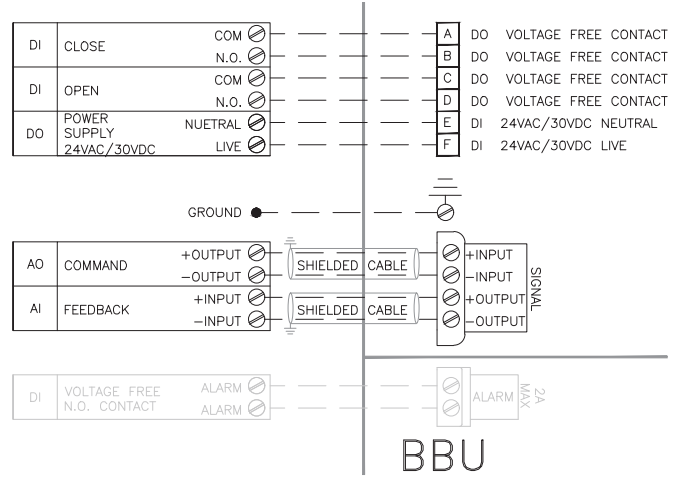

### BBU DIP SWITCH DETAIL

BBU SN#xxxx12xxxxxxxxxxx AND BBU SN# HIGHER THAN ...21...  
 BBU SN#xxxx12xxxxxxxxxxx AND BBU SN# LOWER THAN ...21...

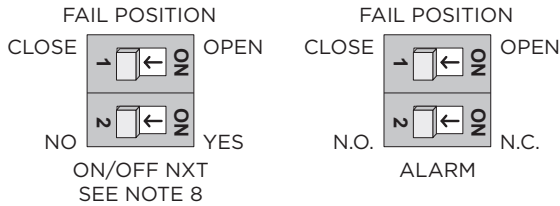

### LED CHART

BATTERY BACKUP UNIT LED FLASH CODES

SLOW GREEN FLASH	BATTERIES CHARGING
STEADY GREEN LIGHT	BATTERIES CHARGED
RAPID RED FLASH	POWER FAIL & VALVE MOVING
SLOW RED FLASH	POWER FAIL & VALVE FINISHED MOVING

### CALIBRATION SEQUENCE:

PLEASE VISIT THE S70 INDUSTRIAL ELECTRIC ACTUATOR SECTION OF OUR WEBSITE AND REFER TO THE QUICK START GUIDE AND VIDEO TUTORIAL LINK IN THE DOCUMENTS SECTION.

### TERMINAL STRIP:

14-24 AWG FOR CONTROLLER & BBU, MAX TIGHTENING TORQUE 3.5 IN-LBS  
 14-22 AWG FOR OTHER, MAX TIGHTENING TORQUE 8 IN-LBS  
 105 °C, 300VAC/DC MIN RATED WIRE





### FUSE:

FAST BLOW 250V 5A  
 5x20MM

### LIMIT SWITCH:

125/250VAC, 10A, 1/2 HP  
 125/250VDC, 0.25A INDUCTIVE  
 125/250VDC, 0.5A RESISTIVE

### LEGEND:

TERMINAL SYMBOLS   
 FIELD WIRING   
 FACTORY WIRING   
 GROUND 

### NOTES:

- ACTUATOR SHOWN IN CLOSED POSITION.
- MANUAL OVERRIDE NOT ENGAGED.
- HEATER OPTIONAL.
- SWITCHES ARE SPDT (FORM C).
- LOSE OF POWER SUPPLY FAIL POSITION IS DETERMINED BY BBU DIP SWITCH #1.  
 FAIL CLOSE: MOVE TOP DIP SWITCH ON BATTERY BACKUP UNIT TO LEFT (CLOSE) POSITION.  
 FAIL OPEN: MOVE TOP DIP SWITCH ON BATTERY BACKUP UNIT TO RIGHT (OPEN) POSITION.
- LOSE OF COMMAND SIGNAL FAIL POSITION IS SET WITH THE NXT DISPLAY.
- OMITTED IN SIZE 6 ACTUATORS.
- FOR BBU SN#xxxx21xxxxxxxxxxx AND SN# HIGHER THAN ...21...  
 BBU DIP SWITCH (DS) #2 IS DEPENDENT ON THE ACTUATOR'S CONTROLLER MODEL.  
 DS#2 ON = CONNECTED TO:  
 NXT ON/OFF CONTROLLER  
 DS#2 OFF = CONNECTED TO:  
 NXT SERVO PRO  
 ON/OFF CONTROLLER  
 PRO SERVO
- WHEN USING 0-10VDC, 0-5VDC & 2-10VDC, THE COMMON OF THE COMMAND SIGNAL SHOULD NOT BE GROUND/EARTH REFERENCED.
- COMMAND SIGNAL AND FEEDBACK SIGNAL MUST BE ISOLATED FROM EACH OTHER AND ANY OTHER CIRCUITS.
- COMMAND SIGNAL & FEEDBACK SIGNAL WIRES SHOULD BE SHIELDED PROPERLY & SHIELD SHOULD BE GROUNDED/EARTHED ON ONE END ONLY, PREFERABLY THE CONTROLLER END.
- FEEDBACK LOOP IS POWERED BY THE SERVO, DO NOT SUPPLY EXTERNAL POWER.
- FEEDBACK LOAD DEVICE NOT TO EXCEED 400 OHMS (4-20mA CONFIGURATION)
- DO NOT INSTALL OR USE THE SERIES 70 ELECTRIC ACTUATOR IN OR NEAR ENVIRONMENTS WHERE CORROSIVE SUBSTANCES OR VAPORS COULD BE PRESENT. EXPOSURE OF THE ELECTRIC ACTUATOR TO CORROSIVE ENVIRONMENTS MAY DAMAGE THE INTERNAL COMPONENTS OF THE DEVICE, AND WILL VOID THE WARRANTY.