

This catalog contains part numbers for the most common replacement parts for QMARK heaters shown in the Table of Contents. Additional parts for these heaters may be available - consult factory for availability. Parts for QMARK heaters not listed in the Table of Contents may be available - consult factory for availability.

NOTE: Parts longer than 8' in length cannot ship UPS. Consult factory for shipping information.

TABLE OF CONTENTS

BASEBOARD	UNIT HEATERS	RADIANT
2500 & QMKC..... 2	CU900 19	BRM 38
Baseboard Accessories 4	CHPR25 21	FRP & FRS 39
HBB 5	IUH 22	HRK 40
	MEDH MODEL D..... 23	RCC 41
WALL HEATERS	MSDH 24	
SSAR 6	PRH 25	PORTABLE
SSHO 7	MUH 26	QPH4A 29
HT 8	MWUH 28	FBE 42
AWH & WHFC 9	MUH35 29	LFP 42
CWH3000 10	QWD 30	FHP 43
CWH1000 11		
CWH ARCHITECTURAL SERIES 12	CONVECTORS	INDUSTRIAL PRODUCTS
LFK 13	KCJ 31	DOE CEILING FANS 44
GFR 14	DBA 32	
SED 15	SHA 32	
COS-E 16	SLQDB 33	
	DBSL..... 34	
SPECIALITY HEATERS	ST..... 35	
QTS 17	CSH 36	
FDI 17	DSH 36	
WHT 17	CPH 36	
	DPH 36	
CEILING HEATERS	THX 37	
QCH 18		
EFF 18		
CDF 18		

OBSOLETE PRODUCTS

WALL HEATERS	CONVECTORS	INDUSTRIAL PRODUCTS
MCSSAR45	KD/KS 59	COMMERCIAL CEILING FANS 65
QFG 46	QDB 59	
EFQ 47	APH 60	
ECP 48	ADB 60	
AFA 49	ASH 60	
CRA 50		
QVP 51	RADIANT	
A2500 51	ARL 61	
1235 & 2435 52	CRN 62	
B2400 52	FFR 63	
CWH2000 53	CHRR 63	
	RDO 64	
PORTABLE	QRH 64	
WPC 54		
	SPECIALITY HEATERS	
UNIT HEATERS	CFWF 17	
TBX 55		
CU-A 56	BASEBOARD	
CU-B 56	CBD 5	
VUH 57		
VUH-A 57		
MEDH 58		

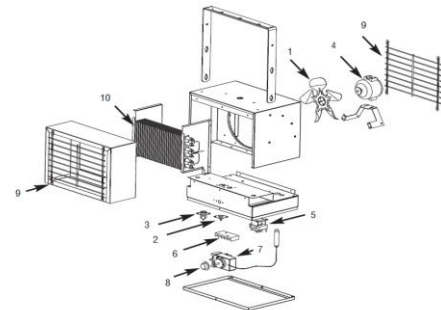

FOR SERVICE PARTS CONTACT CARROLL PARTS 800-654-3545

**C2500 & 2500 SERIES
ELEMENTS**



1802-11021-008 2573WCA 2573NWCA C2573WCA C2573NWCA	1802-11021-009 2543WCA 2543NWCA C2543WCA C2543NWCA	1802-11021-010 2503WCA 2503NWCA C2503WCA C2503NWCA	1802-11021-011 2513WCA 2513NWCA C2513WCA C2513NWCA	1802-2044-014 2574WCA 2574NWCA C2574WCA C2574NWCA	1802-2044-015 2544WCA 2544NWCA C2544WCA C2544NWCA
1802-2044-026 2576WCA 2576NWCA C2576WCA C2576NWCA	1802-2094-017 2546WCSA 2546NWCSA C2546WCSA C2546NWCSA	1802-2044-028 2506WCA 2506NWCA C2506WCA C2506NWCA	1802-2094-015 2516WCSA 2516NWCSA C2516WCSA C2516NWCSA	1802-2044-016 2504WCA 2504NWCA C2504WCA C2504NWCA	1802-2044-017 2514WCA 2514NWCA C2514WCA C2514NWCA
1802-2044-020 2575WCA 2575NWCA C2575WCA C2575NWCA	1802-2044-021 2545WCA 2545NWCA C2545WCA C2545NWCA	1802-2044-022 2505WCA 2505NWCA C2505WCA C2505NWCA	1802-2044-023 2515WCA 2515NWCA C2515WCA C2515NWCA	1802-2094-000 2508WCSA 2508NWCSA C2508WCSA C2508NWCSA	1802-2094-001 2548WCSA 2548NWCSA C2548WCSA C2548NWCSA
1802-11021-000 2572WCA 2572NWCA C2572WCA C2572NWCA	1802-11021-001 2542WCA 2542NWCA C2542WCA C2542NWCA	1802-11021-002 2502WCA 2502NWCA C2502WCA C2502NWCA	1802-11021-003 2512WCA 2512NWCA C2512WCA C2512NWCA	1802-2094-002 2578WCSA 2578NWCSA C2578WCSA C2578NWCSA	1802-2094-003 25008WCSA 25008NWCSA C25008WCSA C25008NWCSA
1802-11021-004 25726WCA 25726NWCA C25726WCA C25726NWCA	1802-11021-005 25426WCA 25426NWCA C25426WCA C25426NWCA	1802-11021-006 25026WCA 25026NWCA C25026WCA C25026NWCA	1802-11021-007 25126WCA 25126NWCA C25126WCA C25126NWCA	1802-2094-004 25408WCSA 25408NWCSA C25408WCSA C25408NWCSA	1802-2094-005 25708WCSA 25708NWCSA C25708WCSA C25708NWCSA

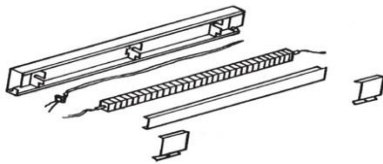

C2500 & 2500 SERIES CONTINUED
THERMAL CUTOUT



4520-2018-000		4520-2018-001		4520-2018-002		4520-2018-003		4520-2018-004	
2512NWC	2512WC	25126NWC	25126WC	2513NWC	2513WC	2514NWC	2514WC	2515NWC	2515WC
2512NWCA	2512WCA	25126NWCA	25126WCA	2513NWCA	2513WCA	2514NWCA	2514WCA	2515NWCA	2515WCA
2502NWC	2502WC	25026NWC	25026WC	2503NWC	2503WC	2504NWC	2504WC	2505NWC	2505WC
2502NWCA	2502WCA	25026NWCA	25026WCA	2503NWCA	2503WCA	2504NWCA	2504WCA	2505NWCA	2505WCA
2542NWC	2542WC	25426NWC	25426WC	2543NWC	2543WC	2544NWC	2544WC	2545NWC	2545WC
2542NWCA	2542WCA	25426NWCA	25426WCA	2543NWCA	2543WCA	2544NWCA	2544WCA	2545NWCA	2545WCA
2572NWC	2572WC	25726NWC	25726WC	2573NWC	2573WC	2574NWC	2574WC	2575NWC	2575WC
2572NWCA	2572WCA	25726NWCA	25726WCA	2573NWCA	2573WCA	2574NWCA	2574WCA	2575NWCA	2575WCA
C2512NWC	C2512WC	C25126NWC	C25126WC	C2513NWC	C2513WC	C2514NWC	C2514WC	C2515NWC	C2515WC
C2502NWC	C2502WC	C25026NWC	C25026WC	C2503NWC	C2503WC	C2504NWC	C2504WC	C2505NWC	C2505WC
C2542NWC	C2502WC	C25426NWC	C25026WC	C2543NWC	C2503WC	C2544NWC	C2504WC	C2545NWC	C2505WC
C2572NWC	C2502WC	C25726NWC	C25026WC	C2573NWC	C2503WC	C2574NWC	C2504WC	C2575NWC	C2505WC
C2542WC		C25426WC		C2543WC		C2544WC		C2545WC	
C2542WCA		C25426WCA		C2543WCA		C2544WCA		C2545WCA	
C2572WC		C25726WC		C2573WC		C2574WC		C2575WC	
C2572WCA		C25726WCA		C2573WCA		C2574WCA		C2575WCA	
4520-2018-005		4520-2018-006		4520-2019-000		4520-2019-001		4520-2019-002	
2516NWC	2516WC	2508NWC	2508WC	2512HNWC	2512HWC	25126HNWC	25126HWC	2513HNWC	2513HWC
2516NWCA	2516WCA	2508NWCA	2508WCA	2512HNWCA	2512HWCA	25126HNWCA	25126HWCA	2513HNWCA	2513HWCA
2506NWC	2506WC	2500NWC	2500WC	2500HNWC	2500HWC	25026HNWC	25026HWC	2503HNWC	2503HWC
2506NWCA	2506WCA	2500NWCA	2500WCA	2500HNWCA	2500HWCA	25026HNWCA	25026HWCA	2503HNWCA	2503HWCA
2546NWC	2546WC	2548NWC	2548WC	2542HNWC	2542HWC	25426HNWC	25426HWC	2543HNWC	2543HWC
2546NWCA	2546WCA	2548NWCA	2548WCA	2542HNWCA	2542HWCA	25426HNWCA	25426HWCA	2543HNWCA	2543HWCA
2546NWC	2546WC	2548NWC	2548WC	2572HNWC	2572HWC	25726HNWC	25726HWC	2573HNWC	2573HWC
2546NWCA	2546WCA	2548NWCA	2548WCA	2572HNWCA	2572HWCA	25726HNWCA	25726HWCA	2573HNWCA	2573HWCA
2576NWC	2576WC	2548NWC	2548WC	2576HNWC	2576HWC	25766HNWC	25766HWC	2577HNWC	2577HWC
2576NWCA	2576WCA	2548NWCA	2548WCA	2576HNWCA	2576HWCA	25766HNWCA	25766HWCA	2577HNWCA	2577HWCA
C2516NWC	C2516WC	2540HNWC	2540HWC	2540HNWC	2540HWC	C25126HNWC	C25126HWC	C2513HNWC	C2513HWC
C2506NWC	C2506WC	2540HNWCA	2540HWCA	2540HNWCA	2540HWCA	C25126HNWCA	C25126HWCA	C2503HNWC	C2503HWC
C2546NWC	C2506WC	2578NWC	2578WC	2540HNWCA	2540HWCA	C25026HNWC	C25026HWC	C2503HNWCA	C2503HWCA
C2576NWC	C2506WC	2578NWC	2578WC	2578NWC	2578WC	C25426HNWC	C25426HWC	C2543HNWC	C2543HWC
C2516WCA	C2516WCA	2578NWC	2578WCA	2578NWC	2578WCA	C25426HNWCA	C25426HWCA	C2543HNWCA	C2543HWCA
C2506WCA	C2506WCA	2578NWC	2578WCA	2578NWC	2578WCA	C25726HNWC	C25726HWC	C2573HNWC	C2573HWC
C2546WCA	C2506WCA	2578NWC	2578WCA	2578NWC	2578WCA	C2576HNWC	C2576HWC	C2577HNWC	C2577HWC
C2576WCA	C2506WCA	2578NWC	2578WCA	2578NWC	2578WCA	C2576HNWCA	C2576HWCA	C2577HNWCA	C2577HWCA
C2516HWC		C2508NWC	C2508WC	C2508NWC	C2508WC	C2508NWC		C2508NWC	
C2516HWCA		C2508NWCA	C2508WCA	C2508NWCA	C2508WCA	C2508NWCA		C2508NWCA	
C2506HWC		C2548NWC	C2548WC	C2548NWC	C2548WC	C2548NWC		C2548NWC	
C2506HWCA		C2548NWCA	C2548WCA	C2548NWCA	C2548WCA	C2548NWCA		C2548NWCA	
C2546HWC		C2508NWC	C2508WC	C2508NWC	C2508WC	C2508NWC		C2508NWC	
C2546HWCA		C2508NWCA	C2508WCA	C2508NWCA	C2508WCA	C2508NWCA		C2508NWCA	
C2576HWC		C2578NWC	C2578WC	C2578NWC	C2578WC	C2578NWC		C2578NWC	
C2576HWCA		C2578NWCA	C2578WCA	C2578NWCA	C2578WCA	C2578NWCA		C2578NWCA	
		C25708NWC	C25708WC	C25708NWC	C25708WC	C25708NWC		C25708NWC	
		C25708NWCA	C25708WCA	C25708NWCA	C25708WCA	C25708NWCA		C25708NWCA	
		C2508NWC	C2508WC	C2508NWC	C2508WC	C2508NWC		C2508NWC	
		C2508NWCA	C2508WCA	C2508NWCA	C2508WCA	C2508NWCA		C2508NWCA	
		C2548HWC	C2548WC	C2548HWC	C2548WC	C2548HWC		C2548HWC	
		C2548HWCA	C2548WCA	C2548HWCA	C2548WCA	C2548HWCA		C2548HWCA	
		C25408HWC	C25408WC	C25408HWC	C25408WC	C25408HWC		C25408HWC	
		C25408HWCA	C25408WCA	C25408HWCA	C25408WCA	C25408HWCA		C25408HWCA	
		C2578HWC	C2578WC	C2578HWC	C2578WC	C2578HWC		C2578HWC	
		C2578HWCA	C2578WCA	C2578HWCA	C2578WCA	C2578HWCA		C2578HWCA	
		C25708HWC	C25708WC	C25708HWC	C25708WC	C25708HWC		C25708HWC	
		C25708HWCA	C25708WCA	C25708HWCA	C25708WCA	C25708HWCA		C25708HWCA	
		C25708HWC		C25708HWC		C25708HWC		C25708HWC	
		C25708HWCA		C25708HWCA		C25708HWCA		C25708HWCA	
4520-2019-005		4520-2019-006		4520-2019-003		4520-2019-004		4520-2019-004	
2516HNWC	2516HWCA	2508HNWC	2508HWC	2514HNWC	2514HWC	2515HNWC	2515HWC	2515HNWC	2515HWC
2516HNWCA	2516HWCA	2508HNWCA	2508HWCA	2514HNWCA	2514HWCA	2515HNWCA	2515HWCA	2515HNWCA	2515HWCA
2506HNWC	2506HWCA	2500HNWC	2500HWC	2504HNWC	2504HWC	2505HNWC	2505HWC	2505HNWC	2505HWC
2506HNWCA	2506HWCA	2500HNWCA	2500HWCA	2504HNWCA	2504HWCA	2505HNWCA	2505HWCA	2505HNWCA	2505HWCA
2546HNWC	2546HWCA	2548HNWC	2548HWC	2544HNWC	2544HWC	2545HNWC	2545HWC	2545HNWC	2545HWC
2546HNWCA	2546HWCA	2548HNWCA	2548HWCA	2544HNWCA	2544HWCA	2545HNWCA	2545HWCA	2545HNWCA	2545HWCA
2576HNWC	2576HWCA	2540HNWC	2540HWC	2574HNWC	2574HWC	2575HNWC	2575HWC	2575HNWC	2575HWC
2576HNWCA	2576HWCA	2540HNWCA	2540HWCA	2574HNWCA	2574HWCA	2575HNWCA	2575HWCA	2575HNWCA	2575HWCA
		2578HNWC	2578HWC	2574HNWCA	2574HWCA	2575HNWC	2575HWC	2575HNWC	2575HWC
		2578HNWCA	2578HWCA	2574HNWCA	2574HWCA	2575HNWCA	2575HWCA	2575HNWCA	2575HWCA
		2578HNWC	2578HWC	2578HNWC	2578HWC	C2515HWCA	C2515HWC	C2515HWCA	C2515HWC
		2578HNWCA	2578HWCA	2578HNWC	2578HWC	C2515HWCA	C2515HWC	C2515HWCA	C2515HWC
		2578HNWC	2578HWC	2578HNWC	2578HWC	C2505HWCA	C2505HWC	C2505HWCA	C2505HWC
		2578HNWCA	2578HWCA	2578HNWC	2578HWC	C2505HWCA	C2505HWC	C2505HWCA	C2505HWC
		2578HNWC	2578HWC	2578HNWC	2578HWC	C2545HWCA	C2545HWC	C2545HWCA	C2545HWC
		2578HNWCA	2578HWCA	2578HNWC	2578HWC	C2545HWCA	C2545HWC	C2545HWCA	C2545HWC
		2508HNWC	2508HWC	2508HNWC	2508HWC	C2575HWCA	C2575HWC	C2575HWCA	C2575HWC
		2508HNWCA	2508HWCA	2508HNWC	2508HWC	C2575HWCA	C2575HWC	C2575HWCA	C2575HWC
		2508HNWC	2508HWC	2508HNWC	2508HWC				
		2508HNWCA	2508HWCA	2508HNWC	2508HWC				
		25708HWC	25708WCA	25708HWC	25708WCA				
		25708HWCA	25708WCA	25708HWC	25708WCA				
		25708HWC		25708HWC					
		25708HWCA		25708HWCA					

C2500 & 2500 SERIES CONTINUED

FACE PLATE



COLOR	FEET	GA.	PART NUMBER	COLOR	FEET	GA.	PART NUMBER
NAVAJO	2.5	18	1402-2122-040	NORTHERN WHITE	2.5	18	1402-2122-061
NAVAJO	3	18	1402-2122-041	NORTHERN WHITE	3	18	1402-2122-062
NAVAJO	4	18	1402-2122-042	NORTHERN WHITE	4	18	1402-2122-063
NAVAJO	5	18	1402-2122-043	NORTHERN WHITE	5	18	1402-2122-064
NAVAJO	6	18	1402-2122-044	NORTHERN WHITE	6	18	1402-2122-065
NAVAJO	8	18	1402-2122-045	NORTHERN WHITE	8	18	1402-2122-066
NAVAJO	2	22	1402-2122-635	NORTHERN WHITE	2	22	1402-2122-623
NAVAJO	2.5	22	1402-2122-628	NORTHERN WHITE	2.5	22	1402-2122-616
NAVAJO	3	22	1402-2122-629	NORTHERN WHITE	3	22	1402-2122-617
NAVAJO	4	22	1402-2122-630	NORTHERN WHITE	4	22	1402-2122-618
NAVAJO	5	22	1402-2122-631	NORTHERN WHITE	5	22	1402-2122-619
NAVAJO	6	22	1402-2122-632	NORTHERN WHITE	6	22	1402-2122-620
NAVAJO	8	22	1402-2122-633	NORTHERN WHITE	8	22	1402-2122-621

NOTE: 18GA IS FOR COMERCIAL MODELS

CONTROL BOX COVER











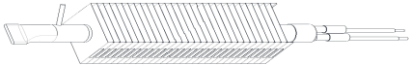

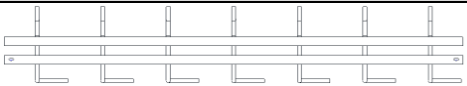

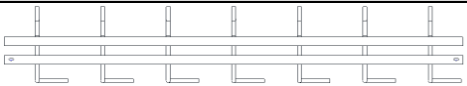











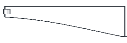

COLOR	GA.	PART NUMBER	COLOR	GA.	PART NUMBER
NAVAJO	24	1402-2261-601	NORTHERN WHITE	24	1402-2261-600
NAVAJO	20	1402-2261-603	NORTHERN WHITE	20	1402-2261-604

NOTE: 20 GA IS FOR COMERCIAL MODELS

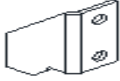

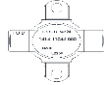
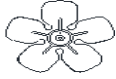
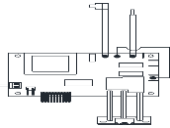

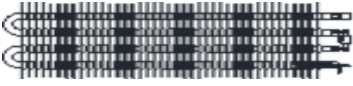
ACCESSORIES

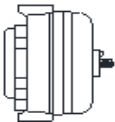
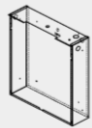
MODEL	KNOBS	THERMOSTATS
T1	3301-2011-000	5813-2014-000
T2	3301-2011-000	5813-2015-000
T1A	3301-2014-006	410127001
T2A	3301-2020-004	410128001
T4		410129001
T4A	3301-2014-006	410129001
T5A	3301-2020-004	410130001
TA1AW	42521-032-10	5813-2009-000
TA2AW	42521-032-08	5813-2010-000
TA1ANW	42521-032-11	5813-2009-000
TA2ANW	42521-032-09	5813-2010-000
TA1AWCA	42521-032-10	5813-2009-000
TA2AWCA	42521-032-08	5813-2010-000
TA1ANWCA	42521-032-11	5813-2009-000
TA2ANWCA	42521-032-09	5813-2010-000

HBB SERIES BASEBOARD											
ELEMENT						LIMIT					
											
1802-2068-000	1802-2068-001	1802-2068-002	1802-2068-003	1802-2068-004	1802-2068-016	410122002	410122003	410122004	410122005	410122006	410122008
500D	7500D	1000D	1250D	1500D	2004D	500D	7500D	1000D	1250D	1500D	2004D
500DA	7500DA	1000DA	1250DA	1500DA	2004DA	500DA	7500DA	1000DA	1250DA	1500DA	2004DA
500DB	7500DB	1000DB	1250DB	1500DB	2004DB	500DB	7500DB	1000DB	1250DB	1500DB	2004DB
1802-2068-011	1802-2068-012	1802-2068-013	1802-2068-014	1802-2068-015	1802-2067-010	504D	7504D	1004D	1254D	1504D	2007D
504D	7504D	1004D	1254D	1504D	2008D	504DA	7504DA	1004DA	1254DA	1504DA	2007DA
504DA	7504DA	1004DA	1254DA	1504DA	2008DA	504DB	7504DB	1004DB	1254DB	1504DB	2007DB
504DB	7504DB	1004DB	1254DB	1504DB		508D	7507D	1007D	1257D	1507D	2008DB
1802-2068-005	1802-2068-006	1802-2068-007	1802-2068-008	1802-2068-009		508DA	7508D	1008D	1258D	1508D	
508D	7508D	1008D	1258D	1508D		508DA	7508DA	1008DA	1258DA	1508DA	
508DA	7508DA	1008DA	1258DA	1508DA		508DB	7508DB	1008DB	1258DB	1508DB	
508DB	7508DB	1008DB	1258DB	1508DB							
FRONT COVER						GRILLE					
											
1402-2066-600	1402-2066-601	1402-2066-602	1402-2066-603	1402-2066-604	1402-2066-605	2501-2012-012	2501-2012-013	2501-2012-014	2501-2012-015	2501-2012-010	2501-2012-011
500D	7500D	1000D	1250D	1500D	2004D	500D	7500D	1000D	1250D	1500D	2004D
500DA	7500DA	1000DA	1250DA	1500DA	2004DA	500DA	7500DA	1000DA	1250DA	1500DA	2004DA
500DB	7500DB	1000DB	1250DB	1500DB	2004DB	500DB	7500DB	1000DB	1250DB	1500DB	2004DB
504D	7504D	1004D	1254D	1504D	2007D	504D	7504D	1004D	1254D	1504D	2007D
504DA	7504DA	1004DA	1254DA	1504DA	2008D	504DA	7504DA	1004DA	1254DA	1504DA	2008D
504DA	7504DA	1004DA	1254DA	1504DA	2008DA	504DB	7504DB	1004DB	1254DB	1504DB	2008DA
504DB	7504DB	1004DB	1254DB	1504DB	2008DB	508D	7507D	1007D	1257D	1507D	2008DB
508D	7507D	1007D	1257D	1507D	2008DB	508DA	7508D	1008D	1258D	1508D	
508DA	7508D	1008D	1258D	1508D		508DB	7508DA	1008DA	1258DA	1508DA	
508DB	7508DB	1008DB	1258DB	1508DB		508DB	7508DB	1008DB	1258DB	1508DB	
FRONT COVER						GRILLE					
											
JUNCTION BOX COVER ALL MODELS 1800-2022-000											
											
CBD SERIES BASEBOARD (OBSOLETE)											
ELEMENT						LIMIT					
											
1802-2056-007	1802-2056-011	1802-2063-017	1802-2063-023	1802-2094-015	1802-2063-033	4520-2018-001	4520-2018-002	4520-2018-003	4520-2018-004	4520-2018-005	4520-2018-006
D500	D750	D1000	D1250	D1500	D2004	D500	D750	D1000	D1250	D1500	D2004
D500A	D750A	D1000A	D1250A	D1500A	D2004A	D500A	D750A	D1000A	D1250A	D1500A	D2004A
1802-2056-005	1802-2056-009	1802-2063-015	1802-2063-021	1802-2063-027	1802-2063-032	D504	D754	D1004	D1254	D1504	D2007
D504	D754	D1004	D1254	D1504	D2007	D504A	D754A	D1004A	D1254A	D1504A	D2007A
D504A	D754A	D1004A	D1254A	D1504A	D2007A	D507	D757	D1007	D1256A	D1507	D2008A
1802-2056-004	1802-2056-008	1802-2063-014	1802-2063-047	1802-2063-026	1802-2063-034	D507A	D757A	D1007A	D1256A	D1507A	D2008A
D507	D757	D1007	D1256	D1507	D2008	D507A	D757A	D1007A	D1256A	D1507A	D2008A
D507A	D757A	D1007A	D1256A	D1507A	D2008A	D508	D758	D1008	D1257A	D1508	
1802-2056-006	1802-2056-010	1802-2063-016	1802-2063-020	1802-2063-028		D508A	D758A	D1008A	D1257A	D1508A	
D508	D758	D1008	D1257	D1508		D508A	D758A	D1008A	D1257A	D1508A	
D508A	D758A	D1008A	D1257A	D1508A							
			1802-2063-022								
			D1258								
			D1258A								
FRONT COVER						GRILLE					
											
1402-2066-010	1402-2066-011	1402-2066-012	1402-2066-013	1402-2066-014	1402-2066-015	2501-2012-012	2501-2012-013	2501-2012-014	2501-2012-015	2501-2012-010	2501-2012-011
D500	D750	D1000	D1250	D1500	D2004	D500	D750	D1000	D1250	D1500	D2004
D500A	D750A	D1000A	D1250A	D1500A	D2004A	D500A	D750A	D1000A	D1250A	D1500A	D2004A
D504	D754	D1004	D1254	D1504	D2007	D504	D754	D1004	D1254	D1504	D2007
D504A	D754A	D1004A	D1254A	D1504A	D2007A	D504A	D754A	D1004A	D1254A	D1504A	D2007A
D507	D757	D1007	D1256	D1507	D2008	D507A	D757A	D1007A	D1256A	D1507A	D2008A
D507A	D757A	D1007A	D1256A	D1507A	D2008A	D508	D758	D1008	D1257A	D1508	
D508	D758	D1008	D1257	D1508		D508A	D758A	D1008A	D1257A	D1508A	
D508A	D758A	D1008A	D1257A	D1508A							
			D1258								
			D1258A								
FRONT COVER						GRILLE					
											
JUNCTION BOX COVER ALL MODELS 1800-2022-000											
											
SEE ACCESSORIES ON 2500 SERIES PAGE FOR T1 & T2 THERMOSTAT PARTS											

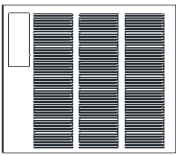
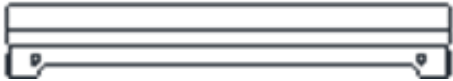

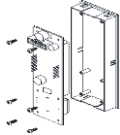
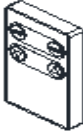
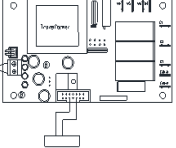
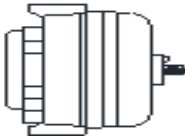

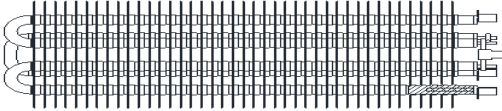
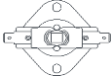
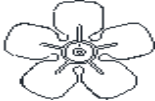
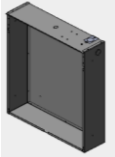



SSAR SERIES							
RIGHT BEZEL	LEFT BEZEL	DISPLAY ASSM.	BOTTOM BRACKET LT.	BOTTOM BRACKET RT.	REMOTE	EOL LIMIT	FAN BLADE
							
1219-11009-001 ALL MODELS	1219-11009-000 ALL MODELS	1016-11188-000 ALL MODELS	1215-11070-000 ALL MODELS	1215-11070-001 ALL MODELS	1414-11037-001 ALL MODELS	1414-11046-000 ALL MODELS	490030103 ALL MODELS
PWR CONTROL BOARD			DISCONNECT SWITCH	ELEMENT			
							
1414-11033-002 ARWH1802 ARWH1802AL ARWH1802BZ ARWH1802W	1414-11033-001 ARWH4807 ARWH4807AL ARWH4807BZ ARWH4807W	1414-11033-000 ARWH4808 ARWH4804 ARWH4808AL ARWH4804AL ARWH4808BZ ARWH4804BZ ARWH4808W ARWH4804W	410170001 ARWH1802 ARWH1802AL ARWH1802BZ ARWH1802W ARWH4804 ARWH4804AL ARWH4804BZ ARWH4804W ARWH4807 ARWH4807AL ARWH4807BZ ARWH4807W	302012828 ARWH1802 ARWH1802AL ARWH1802BZ ARWH1802W	1802-2075-801 ARWH4808 ARWH4808AL ARWH4808BZ ARWH4808W	302012810 ARWH4804 ARWH4804AL ARWH4804BZ ARWH4804W	302012811 ARWH4807 ARWH4807AL ARWH4807BZ ARWH4807W
MOTOR			BACK BOX	PARTS KIT			
							
3900-11026-002 ARWH1802 ARWH1802AL ARWH1802BZ ARWH1802W	3900-11026-001 ARWH4807 ARWH4807AL ARWH4807BZ ARWH4807W	3900-11026-000 ARWH4808 ARWH4804 ARWH4808AL ARWH4804AL ARWH4808BZ ARWH4804BZ ARWH4808W ARWH4804W	1203-11011-000 ALL MODELS	1205-11023-000 ALL MODELS			



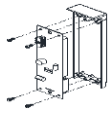
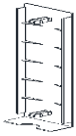

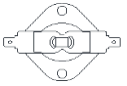
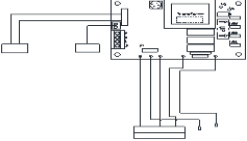
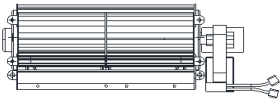

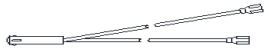

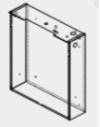



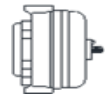

SSHO SERIES

GRILLE			GRILLE TABS (2 REQ)			LIGHT
						
2501-11022-000 HOSS4004 HOSS4007 HOSS4008	2501-11022-001 HOSS4004SB HOSS4007SB HOSS4008SB	2501-11022-002 HOSS4004NV HOSS4007NV HOSS408NV	1402-2120-002 HOSS4004 HOSS4007 HOSS4008	1402-2120-001 HOSS4004SB HOSS4007SB HOSS4008SB	1402-2120-000 HOSS4004NV HOSS4007NV HOSS408NV	3510-2017-005 ALL MODELS
DISPLAY ASSM.	REMOTE	CTRL PWR BOARD		MOTOR		DISCONNECT SWITCH
						
1016-11199-000 ALL MODELS	1414-11037-001 ALL MODELS	1414-11043-000 HOSS4004 HOSS4004NV HOSS4004SB HOSS4008 HOSS408NV HOSS4008SB	1414-11043-001 HOSS4007 HOSS4007NV HOSS4007SB	3900-2002-522 HOSS4004 HOSS4004NV HOSS4004SB HOSS4008 HOSS408NV HOSS4008SB	3900-2002-523 HOSS4007 HOSS4007NV HOSS4007SB	410170001 ALL MODELS
ELEMENT			MANUAL LIMIT	FAN BLADE	BACK BOX	PARTS KIT
						
1802-11005-000 HOSS4008 HOSS408NV HOSS4008SB	1802-11005-001 HOSS4004 HOSS4004NV HOSS4004SB	1802-11005-002 HOSS4007 HOSS4007NV HOSS4007SB	4520-2027-000 ALL MODELS	490030103 ALL MODELS	1016-11242-000 ALL MODELS	1205-2020-002 ALL MODELS







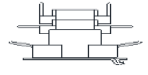



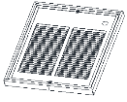
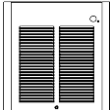

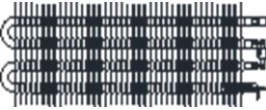
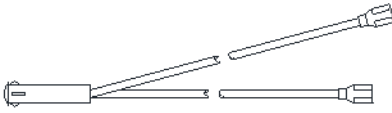
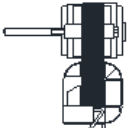
HT SMART SERIES

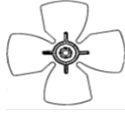

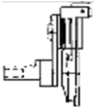

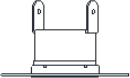

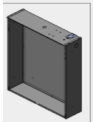





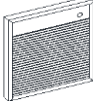

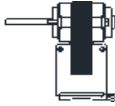
GRILLE PANEL		GRILLE ASSY INSERT		DISPLAY BEZEL	BOTTOM BEZEL	REMOTE	MANUAL LIMIT
							
2501-11003-003 HT1502SS HT2024SS	2501-11003-004 HT1502SSNW HT2024SSNW	1016-11063-000 HT1502SS HT2024SS	1016-11063-001 HT1502SSNW HT2024SSNW	1016-11035-003 HT1502SS HT2024SS HT1502SSNW HT2024SSNW	1219-11004-000 ALL MODELS	1414-11017-001 ALL MODELS	4520-11005-000 ALL MODELS
CNTRL PWR BOARD		BLOWER MOTOR		ELEMENT		LIGHT	
							
1414-11007-002 HT1502SS HT1502SSNW	1414-11007-003 HT2024SS HT2024SSNW	1225-11001-000 HT1502SS HT1502SSNW	1225-11001-001 HT2024SS HT2024SSNW	302023802 HT1502SS HT1502SSNW	302023805 HT2024SS HT2024SSNW	3510-2010-000 HT1502SS HT1502SSNW	3510-2010-001 HT2024SS HT2024SSNW
BACK BOX	PARTS KIT						
							
1016-11032-000 ALL MODELS	1205-11010-000 ALL MODELS						

CWH3000 SERIES											
KNOB		GRILLE				MOTOR			FAN BLADE		
											
3301-11014-001 WHB3150FC WHB3180C WHB3307FC WHB3404FC WHB34043FC WHB3407FC WHB3408FC WHB34083FC WHB3504FC WHB35043FC WHB3507FC WHB3508FC WHB35083FC	CWH3157A CWH3204A CWH3207A CWH3208A CWH3307A CWH3404A CWH3407A CWH3408A CWH3504A CWH3507A CWH3157AWWW CWH3204AWWW CWH3207AWWW CWH3208AWWW CWH3307AWWW CWH3404AWWW CWH3407AWWW CWH3408AWWW CWH3504AWWW CWH3507AWWW	3301-2016-000 CWH34043 CWH3406 CWH34083 CWH3503 CWH3506 CWH35083 CWH35083B CWH3150 CWH3153B CWH3156B CWH3157B CWH3203B CWH3204B CWH3206B CWH3207B CWH3208B CWH3303B CWH3306B CWH3307B	CWH3308B CWH3404B CWH34043B CWH3406B CWH3407B CWH3408B CWH34083B CWH3503B CWH3504B CWH35043B CWH3506B CWH3507B CWH3508B CWH35083B	1016-11226-000 WHB3150FC WHB3180C WHB3307FC WHB3404FC WHB34043FC WHB3407FC WHB3408FC WHB34083FC WHB3504FC WHB35043FC WHB3507FC WHB3508FC WHB35083FC	2501-2019-001 CWH3157AWWW CWH3204AWWW CWH3207AWWW CWH3208AWWW CWH3307AWWW CWH3404AWWW CWH3407AWWW CWH3408AWWW CWH3504AWWW CWH3507AWWW CWH3157B CWH3203B CWH3204B CWH3206B CWH3207B CWH3208B CWH3303B CWH3306B	CWH3307B CWH3308B CWH3404B CWH34043B CWH3406B CWH3407B CWH3408B CWH34083B CWH3503B CWH3504B CWH35043B CWH3506B CWH3507B CWH3508B CWH35083B	3900-2010-001 CWH3157A CWH3207A CWH3307A CWH3407A CWH3507A CWH3157AWWW CWH3207AWWW CWH3307AWWW CWH3407AWWW CWH3507AWWW CWH3157B CWH3207B CWH3307B CWH3407B CWH3507B WHB3307FC WHB3407FC WHB3507FC	3900-2010-000 CWH3204A CWH3208A CWH3404A CWH3408A CWH3504A CWH3204AWWW CWH3208AWWW CWH3404AWWW CWH3408AWWW CWH3504AWWW CWH3406 CWH3204B CWH3208B CWH3404B CWH3408B CWH3504B CWH3404FC CWH3408FC CWH3504FC	3900-2010-003 CWH3150 CWH3180 WHB3150FC WHB3180C 3900-2002-510 CWH3204AWWW CWH3156B CWH3203B CWH3206B 3900-2002-519 CWH3303B CWH3306B CWH3308B CWH3406B CWH3503B CWH3506B	3900-2002-518 CWH34043 CWH34083 CWH35043 CWH35083 CWH34043B CWH34083B CWH35043B CWH35083B WHB34043FC WHB35043FC WHB35083FC WHB35083FC	490030103 ALL MODELS BACK BOX  1016-11243-500 ALL MODELS PARTS KIT 1205-11031-001 ALL MODELS
ELEMENT 				THERMOSTAT 			MANUAL LIMIT 	TIME DELAY RELAY 			
302015801 CWH3208A CWH3208AWWW CWH3208B CWH3208BWW CWH3307A CWH3307AWWW CWH3307B WHB3307FC 302012810 CWH3504A CWH3504AWWW CWH3504B WHB3504FC 302012816 CWH3156B CWH3156BWW 302012818 CWH3206B CWH3206BWW 302012819 CWH3303B	302015802 CWH3204A CWH3204AWWW CWH3204B CWH3204BWW 302012807 CWH3408A CWH3408AWWW CWH3408B CWH3408BWW WHB3408FC 302012811 CWH3507A CWH3507AWWW CWH3507B WHB3507FC 302012820 CWH3306B CWH3306BWW 302012821 CWH3308B CWH3308BWW 302012822 CWH3406 CWH3406BWW	302015803 CWH3207A CWH3207AWWW CWH3207B CWH3207BWW CWH3404A CWH3404AWWW CWH3404B CWH3404BWW WHB3404FC 302012823 CWH3503 CWH3503B 302012824 CWH3153B CWH3153BWW 302012821 CWH3506B CWH3506BWW 302012827 CWH3150 CWH3150FC	302015806 CWH3157A CWH3157AWWW CWH3157B CWH3157BWW CWH3407A CWH3407AWWW CWH3407B CWH3407BWW WHB3407FC 302012828 CWH3180 WHB3180C 1802-2075-800 CWH34083 CWH34083B WHB34083FC 1802-2075-802 CWH34043 CWH34043B WHB34043FC	1802-2075-801 CWH35083 CWH3508B CWH35083B WHB3508FC CWH35043 CWH35043B WHB35043FC	410168002 CWH3157A CWH3204A CWH3207A CWH3208A CWH3307A CWH3404A CWH3407A CWH3504A CWH3507A CWH3157AWWW CWH3204AWWW CWH3207AWWW CWH3208AWWW CWH3307AWWW CWH3404AWWW CWH3407AWWW CWH3408AWWW CWH3504AWWW CWH3507AWWW CWH34043	5813-2059-000 CWH3150 CWH3180 CWH3153B CWH3156B CWH3157B CWH3203B CWH3204B CWH3206B CWH3207B CWH3303B CWH3306B CWH3307B CWH3308B CWH3404B CWH34043B CWH3406B CWH3408B CWH34083B CWH3503B	4520-2027-000 ALL MODELS AUTO LIMIT 	410171003 CWH3203B CWH3206B			
DISCONNECT SWITCH 				FAN DELAY 			RELAY MODELS BEFORE 2020 	TRANSFORMER 			
5216-2019-000 CWH34043 CWH3406 CWH34083 CWH3503 CWH35043 CWH3506 CWH35083 CWH3153B CWH3156B CWH3203B CWH3206B CWH3303B CWH3306B CWH3308B CWH34043B CWH3406B CWH34083B CWH3503B CWH35043B CWH3506B CWH3508B	CWH35083B WHB34043FC WHB34083FC WHB35043FC WHB35083FC WHB35083FC	410170001 CWH3157A CWH3204A CWH3207A CWH3208A CWH3307A CWH3404A CWH3407A CWH3504A CWH3507A CWH3157AWWW CWH3204AWWW CWH3207AWWW CWH3208AWWW CWH3307AWWW CWH3404AWWW CWH3407AWWW CWH3504AWWW CWH3507AWWW CWH3150	CWH3180 CWH3157B CWH3204B CWH3207B CWH3208B CWH3307B CWH3404B CWH3407B CWH3504B CWH3507B CWH3307B CWH3308B CWH3404B CWH3407B CWH3504B CWH3507B CWH3150FC WHB3180C WHB3404FC WHB3407FC WHB3504FC WHB3507FC	4520-2024-000 CWH34043 CWH34083 CWH35043 CWH35083 CWH3153B CWH3156B	410074000 CWH3157A CWH3204A CWH3207A CWH3208A CWH3307A CWH3404A CWH3407A CWH3408A CWH3504A CWH3507A CWH3157AWWW CWH3204AWWW CWH3207AWWW CWH3208AWWW CWH3307AWWW CWH3404AWWW CWH3407AWWW CWH3408AWWW CWH3504AWWW CWH3507AWWW CWH3406 CWH35043B	CWH3506B CWH3507B CWH3508B CWH35083B WHB3150FC WHB3180C WHB3307FC WHB3404FC WHB34043FC WHB3407FC WHB3408FC WHB34083FC WHB3504FC WHB35043FC WHB3507FC WHB3508FC WHB35083FC	5018-2017-000 CWH34043 CWH35043 CWH3153B CWH3156B CWH3203B CWH3403B CWH35043B RELAY  410101002 WHB34043FC WHB35043FC WHB34083FC WHB35083FC WHB35083FC	5018-2017-004 CWH34083 CWH34083B CWH3508B CWH35083B	490015017 CWH3156B CWH3206B CWH3306B CWH3406B CWH3506B 490015013 CWH3153B CWH3203B CWH3303B CWH3308B CWH3503B		















CWH1000 SERIES



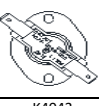
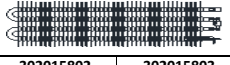



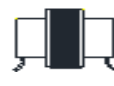
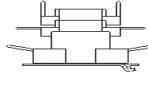
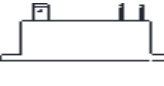



GRILLE		KNOB		ELEMENT		
						
2501-2058-000 CWH1101DS CWH1151DS CWH1157DS CWH1201DS CWH1202DS CWH1207DS CWH1208DS CWH1101DSA CWH1151DSA CWH1157DSA CWH1201DSA CWH1202DSA CWH1207DSA CWH1208DSA	1016-11228-000 WHB1101FC WHB1151FC WHB1157FC WHB1201FC WHB1202FC WHB1207FC WHB1208FC	3301-2001-000 CWH1101DS CWH1151DS CWH1157DS CWH1201DS CWH1202DS CWH1207DS CWH1208DS CWH1101DSA CWH1151DSA CWH1157DSA CWH1201DSA CWH1202DSA CWH1207DSA CWH1208DSA	3301-11015-001 WHB1101FC WHB1151FC WHB1157FC WHB1201FC WHB1202FC WHB1207FC WHB1208FC	302023801 CWH1101DS CWH1101DSA WHB1101FC 302023804 CWH1208DS CWH1208DSA WHB1208FC 302023808 CWH1201DS CWH1201DSA WHB1201FC	302023802 CWH1151DS CWH1151DSA WHB1151FC 302023805 CWH1202DS CWH1202DSA WHB1202FC	302023803 CWH1157DS CWH1157DSA WHB1157FC 302023806 CWH1207DS CWH1207DSA WHB1207FC
LIGHT		MOTOR		DISCONNECT SWITCH	FAN BLADE	
						
3510-2017-007 CWH1101DS CWH1151DS CWH1201DS CWH1101DSA CWH1151DSA CWH1201DSA WHB1101FC WHB1151FC WHB1201FC	3510-2017-006 CWH1157DS CWH1157DSA CWH1207DS CWH1207DSA CWH1202DS CWH1202DSA CWH1208DS CWH1208DSA WHB1157FC WHB1202FC WHB1207FC WHB1208FC		490062001 CWH1101DS CWH1151DS CWH1201DS CWH1101DSA CWH1151DSA CWH1201DSA WHB1101FC WHB1151FC WHB1201FC 490062002 CWH1208DS CWH1208DSA CWH1208FC	490062003 CWH1202DS CWH1202DSA WHB1202FC 490062004 CWH1157DS CWH1207DS CWH1157DSA CWH1207DSA WHB1157FC WHB1207FC	410170001 ALL MODELS CWH  WHB 	490061001 ALL MODELS
THERMOSTAT	THERMAL FUSE	FAN DELAY	HI LIMIT	MANUAL LIMIT	BACK BOX	
						
5813-2001-000 CWH1101DS CWH1151DS CWH1157DS CWH1202DS CWH1207DS CWH1208DS CWH1101DSA CWH1151DSA CWH1157DSA CWH1202DSA CWH1207DSA CWH1208DSA WHB1101FC WHB1151FC WHB1157FC WHB1202FC WHB1207FC WHB1208FC	5813-2022-000 CWH1201DS CWH1201DSA WHB1201FC	4520-2030-000 CWH1101DSA CWH1151DSA CWH1157DSA CWH1201DSA CWH1202DSA CWH1207DSA CWH1208DSA WHB1101FC WHB1151FC WHB1157FC WHB1201FC WHB1202FC WHB1207FC WHB1208FC	410074000 ALL MODELS	410143000 CWH1101DS CWH1151DS CWH1157DS CWH1201DS CWH1202DS CWH1207DS CWH1208DS	4520-11016-000 CWH1101DSA CWH1151DSA CWH1157DSA CWH1201DSA CWH1202DSA CWH1207DSA CWH1208DSA WHB1101FC WHB1151FC WHB1157FC WHB1201FC WHB1202FC WHB1207FC WHB1208FC	1217-2027-507 ALL MODELS PARTS KIT 1205-11032-000 ALL MODELS

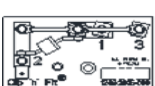

CWH ARCHITECTURAL SERIES (SWH)

KNOB		GRILLE		ELEMENT		
						
3301-11015-003 SWH1012FC SWH1512FC SWH1527FC SWH1812FC SWH2020FC SWH2024FC SWH2027FC	3301-2052-002 SWH1012AG SWH1512AG SWH1527AG SWH1812AG SWH2020AG SWH2024AG SWH2027AG SWH1012AGA SWH1512AGA SWH1527AGA SWH1812AGA SWH2020AGA SWH2024AGA SWH2027AGA	1016-11227-000 SWH1012FC SWH1512FC SWH1527FC SWH1812FC SWH2020FC SWH2024FC SWH2027FC	2501-2075-000 SWH1012AG SWH1512AG SWH1527AG SWH1812AG SWH2020AG SWH2024AG SWH2027AG SWH1012AGA SWH1512AGA SWH1527AGA SWH1812AGA SWH2020AGA SWH2024AGA SWH2027AGA	302023801 SWH1012AG SWH1012AGA SWH1012FC 302023804 SWH2020AG SWH2020AGA SWH2020FC 302023808 SWH1812AG SWH1812AGA SWH1812FC	302023802 SWH1512AG SWH1512AGA SWH1512FC 302023805 SWH2024AG SWH2024AGA SWH2024FC	302023803 SWH1527AG SWH1527AGA SWH1527FC 302023806 SWH2027AG SWH2027AGA SWH2027FC
LIGHT				MOTOR		DISCONNECT SWITCH
						
3510-2008-002 SWH1527AG	3510-2008-003 SWH1012AG SWH1512AG SWH1812AG SWH2020AG SWH2024AG SWH2027AG	3510-2017-007 SWH1012AGA SWH1512AGA SWH1812AGA SWH1012FC SWH1512FC SWH1812FC	3510-2017-006 SWH1527AGA SWH2020AGA SWH2024AGA SWH2027AGA SWH1527FC SWH2020FC SWH2024FC SWH2027FC	490062001 SWH1012AG SWH1512AG SWH1812AG SWH1012AGA SWH1512AGA SWH1812AGA SWH1012FC SWH1512FC SWH1812FC 490062002 SWH2020AG SWH2020AGA SWH2020FC	490062003 SWH2024AG SWH2024AGA SWH2024FC 490062004 SWH1527AG SWH2027AG SWH1527AGA SWH2027AGA SWH1527FC SWH2027FC	410170001 ALL MODELS BACK BOX  1217-2027-507 ALL MODELS PARTS KIT 1205-11032-001 ALL MODELS
FAN DELAY	HI LIMIT	MANUAL LIMIT	FAN BLADE	THERMAL FUSE	THERMOSTAT	
						
410074000 ALL MODELS	410143000 SWH1012AG SWH1512AG SWH1527AG SWH1812AG SWH2020AG SWH2024AG SWH2027AG	4520-11016-000 SWH1012AGA SWH1512AGA SWH1527AGA SWH1812AGA SWH2020AGA SWH2024AGA SWH2027AGA SWH1012FC SWH1512FC SWH1527FC SWH1812FC SWH2020FC SWH2024FC SWH2027FC	490061001 ALL MODELS	4520-2030-000 SWH1012AGA SWH1512AGA SWH1527AGA SWH1812AGA SWH2020AGA SWH2024AGA SWH2027AGA SWH1012FC SWH1512FC SWH1527FC SWH1812FC SWH2020FC SWH2024FC SWH2027FC	5813-2022-000 SWH1812AG SWH1812AGA SWH1812FC	5813-2001-000 SWH1012AG SWH1512AG SWH1527AG SWH2020AG SWH2024AG SWH2027AG SWH1012AGA SWH1512AGA SWH1527AGA SWH2020AGA SWH2024AGA SWH2027AGA SWH1012FC SWH1512FC SWH1527FC SWH2020FC SWH2024FC SWH2027FC
SWH-AG 	SWH-FC 					

LFK-SERIES



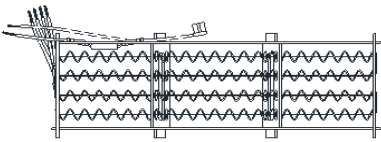
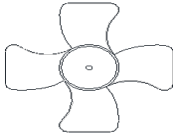
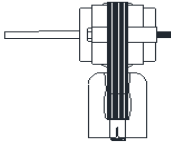
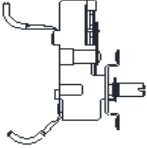
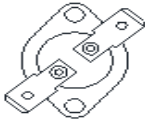
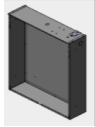

GRILLE			KNOB		FAN DELAY			MANUAL LIMIT
								
1402-2239-000 K151 K157A K204A K207A K208A K303A K304A K306A K307A K403A K404A K404A K403A K406A K407A K408A K4083A K483A K484A K4843A K486A K487A K488A K4883A	1402-2152-000 K204 K207 K208 K303 K304 K306 K307 K403 K404 K403A K404A K408 K406A K407A K408A K483A K484A K4843A K486A K487A K488A K4883A	2501-11028-000 K151FC K204FC K303FC K304FC K306FC K403FC K404FC K406FC K408FC K4083FC K404 K483FC K484FC K486FC K487FC K488FC K4883FC	3301-2030-001 K151 K204 K207A K208 K303 K304 K306 K307 K403 K404 K404A K404A K408 K408A K4083 K483A K484A K484A K486A K487A K488A K4883A K157A	3301-11014-001 K151FC K204FC K207A K208A K303A K304A K306A K307A K403A K404A K404A K408A K408A K4083A K483A K484A K486A K487A K488A K4883A	4520-2024-000 K4043 K4043A K4083 K4083A K4083A K4843 K4843A K488 K4883 K488A K4883A K4883A K4883A K4883A K4883A	410074000 K204 K204A K204FC K208 K208A K303 K303A K303FC K304 K304A K304FC K306 K306A K403 K403A K404 K404A K404A K406A K407A K407A	K406FC K408 K408A K408FC K483 K483A K483FC K484 K484A K484FC K486 K486A K486FC K207 K207A K307 K307A K307A K487 K487A K487A K487FC K157A K407A	ALL MODELS AUTO LIMIT  K4043 K4043A K4843 K4843A K4083 K4083A K4083FC K488 K4883 K488A K4883A K488FC K4883FC
ELEMENTS				MOTOR				FAN BLADE
								
302012827 K151 K151FC	302015802 K204 K204A K204FC	302015803 K207 K207A	302015801 K208 K208A	3900-2010-003 K151 K151FC	3900-2010-000 K204 K204A K204FC K208 K208A K303 K303A K303FC K304 K304A K304FC K306 K306A K306A K403 K403A K403FC K404	3900-2010-001 K207 K207A K307 K307A K487 K487A K487FC K157A K407A	3900-2002-518 K4043 K4043A K4083 K4083A K4083FC K4843 K4843A K488 K4883 K488A K4883A K488FC K4883FC	490030103 ALL MODELS BACK BOX  1016-11243-500 ALL MODELS PARTS KIT 1205-11031-002 ALL MODELS
THERMOSTAT			TRANSFORMER		RELAY	RELAY MODELS BEFORE 2020		
								
410168002 K4043 K4043A K4843 K4843A	5813-2027-000 K204 K204A K204FC K208 K208A K303 K303A K303FC K304 K304A K304FC K306 K306A K306A K403 K403A K403FC K404 K404A		K207A K307 K307A K487 K487A K487FC K157A K407A K4083 K4083A K4083A K488 K488 K488A K488A K4883A K488FC K4883FC	490015017 K303 K403 K483 K303A K403A K483A K303FC K403FC K483FC	490015013 K306 K406 K486 K306A K406A K486A K306FC K406FC K486FC	410101002 K4043 K4043A K4843 K4843A	5018-2017-000 K4043 K4043A K4843 K4843A	5018-2017-004 K4083 K4083A K4083FC K488 K4883 K488A K4883A K488FC K4883FC
					LFK-F	LFK		
								





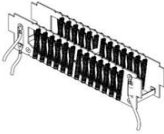
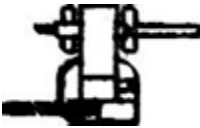

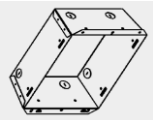

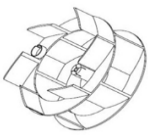

GFR SERIES								
KNOB		GRILLE			LIGHT			
								
3301-2014-004 R1500T2 R2004T2 R2404T2 R1500T2A R2004T2A R2404T2A R1500T2B R2004T2B R2404T2B	3301-11015-002 R1500T2FC R2004T2FC R2404T2FC	2501-11031-000 R1500FC R1500T2FC R2004FC R2004IFFC R2004T2FC R2404FC R2404IFFC R2404T2FC	2501-2026-000 R1500 R1500T2 R2004 R2004IF R2004T2 R2404 R2404IF R2404T2 R1500A R1500T2A R2004A R2004IFA		R2004T2A R2404A R2404IFA R2404T2A R1500B R1500T2B R2004B R2004IFB R2004T2B R2404B R2404IFB R2404T2B	3510-2010-000 R1500 R1500T2 R1500A R1500T2A R1500B R1500T2B R1500FC R1500T2FC	3510-2010-001 R2004 R2004IF R2004T2 R2004A R2004IFA R2004T2A R2004B R2004IFB R2004T2B R2004FC R2004IFFC R2004T2FC	R2404 R2404IF R2404T2 R2404A R2404IFA R2404T2A R2404B R2404IFB R2404T2B R2404FC R2404IFFC R2404T2FC
BLOWER ASM.				ELEMENT			CLIP N FIT BOARD	
								
1225-2002-000 R1500 R1500T2 R1500A R1500T2A R1500B R1500T2B R1500FC R1500T2FC	R2404A R2404IFA R2404T2A R2404B R2404IFB R2404T2B R2404FC R2404IFFC R2404T2FC	1225-2002-001 R2004 R2004IF R2004T2 R2404 R2404IF R2404T2 R2004A R2004IFA R2004T2A	R2004B R2004IFB R2004T2B R2004FC R2004IFFC R2004T2FC	302023802 R1500 R1500T2 R1500A R1500T2A R1500B R1500T2B R1500FC R1500T2FC	302023805 R2004 R2004IF R2004T2 R2004A R2004IFA R2004T2A R2004B R2004IFB R2004T2B R2004FC R2004IFFC R2004T2FC	302023814 R2404 R2404IF R2404T2 R2404A R2404IFA R2404T2A R2404B R2404IFB R2404T2B R2404FC R2404IFFC R2404T2FC	1249-2005-000 ALL MODELS BACK BOX  1217-2044-000 ALL MODELS PARTS KIT 1205-11033-000 ALL MODELS	
THERMOSTAT	TEMPERATURE REGULATOR			HI-LIMIT				
								
410130001 R1500T2 R2004T2 R2404T2 R1500T2A R2004T2A R2404T2A R1500T2B R2004T2B R2404T2B R1500T2FC R2004T2FC R2404T2FC	410143000 R1500 R1500T2 R2004 R2004IF R2004T2 R1500A R1500T2A R2004A R2004IFA R2004T2A		4520-2029-000 R2404 R2404IF R2404T2 R2404A R2404IFA R2404T2A R2404B R2404IFB R2404T2B R2404FC R2404IFFC R2404T2FC	4520-2025-000 R1500 R1500T2 R2004 R2004IF R2004T2 R1500A R1500T2A R2004A R2004IFA R2004T2A	4520-2025-001 R2404 R2404IF R2404T2 R2404A R2404IFA R2404T2A	4520-11010-000 R1500B R1500T2B R1500FC R1500T2FC	4520-11010-001 R2004B R2004IFB R2004T2B R2004FC R2004IFFC R2004T2FC R2404B R2404IFB R2404T2B R2404FC R2404IFFC R2404T2FC	



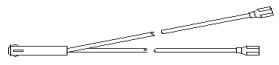
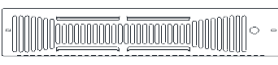
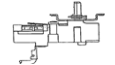

SED SERIES					
KNOB		GRILLE		LIGHT	
					
3301-2044-001 D1012C D1024C D1012CA D1024CA	3301-2039-002 D1012W D1512 D2024 D1012WA D1024WA D1512A D2024A	2501-2054-001 D1012C D1024C D1512CR D1012CA D1024CA D1512CRA	2501-2054-000 D1012W D1512 D2024 D1012WA D1024WA D1512A D2024A	3510-2017-002 D1012C D1012W D1512 D1512CR D1012CA D1012WA D1512A D1512CRA	3510-2017-003 D1024C D2024 D1024CA D1024WA D2024A
ELEMENT			FAN BLADE	MOTOR	
					
1802-2124-003 D1012C D1012W D1012CA D1012WA	1802-2124-005 D1024C D2024 D1024CA D1024WA D2024A	1802-2124-000 D1512 D1512CR D1512A D1512CRA	1210-2008-000 ALL MODELS	3900-2037-000 D1012C D1012W D1512 D1512CR D1012CA D1012WA D1512A D1512CRA	3900-2037-001 D1024C D2024 D1024CA D1024WA D2024A
THERMOSTAT		LIMIT			BACK BOX
					
410130001 D1012C D1012W D1512 D1012CA D1012WA D1512A D1024C D2024		4520-11009-000 D1012C D1012W D1512 D1512CR D1024C D2024		4520-11009-001 D1024CA D1024WA D2024A	1217-2062-000 ALL MODELS PARTS KIT 1205-2049-501 ALL MODELS





COZ-E WALL HEATER

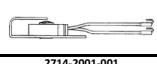
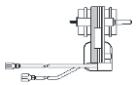
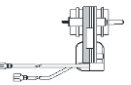







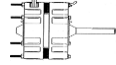

ELEMENT (INCLUDES LIMIT & ONE SHOT FUSE)		MOTOR		GRILLE
				
1802-11014-011 CZ1012T	1802-11014-010 CZ1512T	3900-11032-000 CZ1012IF CZ1012T CZ1512IF CZ1512T	3900-11032-001 CZ1048IF CZ1048T CZ1548IF CZ1548T CZ2048IF CZ2048T	2501-11024-000 ALL MODELS
1802-11014-014 CZ1048T	1802-11014-013 CZ1548T			BACK BOX
	1802-11014-012 CZ2048T			
				1217-11030-000 ALL MODELS
THERMOSTAT	FAN IMPELLER	PARTS KIT		
		PICTURE NOT AVAILABLE		
5813-2090-000 CZ1012T CZ1048T CZ1512T CZ1548T CZ2048T	2002-11004-000 ALL MODELS	1205-11028-500 CZ1012T CZ1048T CZ1512T CZ1548T CZ2048T		

QTS SERIES									
ELEMENTS		MOTOR ASSEMBLY		HI-LIMIT	SELF HOLD LIMIT	FAN DELAY			
									
302023811 S1100 S1100A S1100B S1100C S1100CNW	302023803 S1104 S1104A S1104B S1104C S1104CNW	1225-2002-000 S1100 S1100A S1100B S1100C S1100CNW	1225-2002-001 S1104 S1104A S1104B S1104C S1104CNW	4520-2031-000 S1100 S1100A S1100B S1104 S1104A S1104B S1500 S1500A S1500B S1500C S1500T S1500TA S1500TB S1500TC S1500TCNW	4520-11011-000 S1100C S1100CNW S1500C S1500TC S1500TCNW	1414-2020-000 S1100 S1100A S1104 S1104A S1500 S1500A S1500T S1500TA S1504 S1504A S1504T S1504TA	410074000 S1100B S1100C S1100CNW S1104B S1104C S1104CNW S1500B S1500C S1500TB S1500TC S1500TCNW S1504B S1504C S1504TB S1504TCNW		
302023802 S1500 S1500A S1500B S1500C S1500T S1500TA S1500TB S1500TC S1500TCNW		302023806 S1504 S1504A S1504B S1504C S1504T S1504TA S1504TB S1504TC S1504TCNW		2501-2039-000 S1500 S1500A S1500B S1500C S1500T S1500TA S1500TB S1500TC S1500TCNW		2501-2039-001 S1500C S1504 S1504A S1504B S1504C S1504T S1504TA S1504TB S1504TC			
PILOT LIGHT 		GRILLE 		THERMOSTAT 		KNOB 		THERMAL CUTOFF 	
3510-2010-000 S1100A S1100B S1100C S1100CNW S1500A S1500B S1500C S1500TA S1500TB S1500TC S1500TCNW	3510-2010-001 S1104 S1104A S1104B S1104C S1104CNW S1504 S1504A S1504B S1504C S1504T S1504TA S1504TB S1504TC S1504TCNW	2501-2039-000 S1100 S1100A S1100B S1100C S1104 S1104A S1104B S1104C S1500 S1500A S1500B S1500C S1500T S1500TA S1500TB S1500TC S1500TCNW		2501-2039-001 S1100CNW S1104CNW S1500CNW S1504CNW		410129001 S1500T S1500TA S1500TB S1500TC S1500TCNW S1504T S1504TA S1504TB S1504TC S1504TCNW	3301-2020-006 S1500T S1500TA S1500TB S1500TC S1500TCNW S1504T S1504TA S1504TB S1504TC S1504TCNW	4520-2030-000 ALL MODELS 	





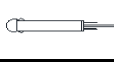





FDI SERIES				
BLADE	ELEMENT		GRILLE	BUZZER
				
1210-0046-000 I1500 I1504	1802-5032-000 I1500	1802-5032-004 I1504	2501-5016-001 I1500 I1504	2714-2001-001 I1500 I1504
MOTOR 		ONE SHOT FUSE BLUE DOT 	HI LIMIT WHITE DOT 	
3900-2025-000 I1500	3900-2025-001 I1504	4520-2041-000 I1500 I1504	4520-5015-001 I1500 I1504	









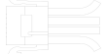

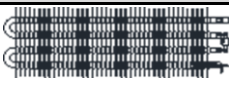
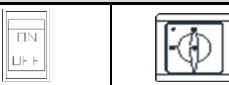
WHT SERIES PUMP HOUSE HEATER		
ELEMENT	KNOB	THERMOSTAT
		
1802-2091-000	3301-2020-006	5813-2062-000

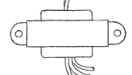
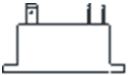









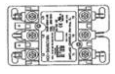

* Neutral grey finish.

CFWF (OBSOLETE)					
TOP FRONT PANEL	BOTTOM FRONT PANEL	TOP TRIM PANEL	MOTOR	RELAY	TRANSFORMER
					
1402-2312-000 CFWF920 CFWF920A	1402-2313-000 CFWF920 CFWF920A	5806-2004-000 CFWF920 CFWF920A	3900-2036-000 CFWF920 CFWF920A	5018-2017-001 CFWF920 CFWF920A	5814-0003-000 CFWF920 CFWF920A
HI-LIMIT 	MANUAL RESET LIMIT 	ELEMENT 	FAN BLADE 	PILOT LIGHT 	CERAMIC LIMITS 
4520-2053-000 CFWF920	4520-2027-000 CFWF920A	1802-2117-101 CFWF920 CFWF920A	1210-2009-001 CFWF920 CFWF920A	3510-2018-000 CFWF920 CFWF920A	4520-2052-000 CFWF920 CFWF920A



QCH (U SERIES)						
GRILLE		PLASTIC COVER (2 REQ)	ELEMENTS		MOTOR	
						
1402-2121-000 U1000 U1000A U1500 U1500A U1507 U1800 U2004 U2004A U2007 U2007A U2008	1016-11228-002 U1000FA U1500FA U2004FA U2007FA	1402-2119-000 U1000 U1000A U1500 U1500A U1507 U1800 U2004 U2004A U2007 U2007A U2008	302023812 U1000 U1000A U1000FA	302023803 U1507 302023808 U1800	490062001 U1000 U1000A U1000FA U1500 U1500A U1500FA U1800	490062003 U2004 U2004A U2004FA
			302023802 U1500 U1500A U1500FA	302023806 U2007 U2007A U2007FA	490062004 U1500 U1500A U1800	490062004 U2007 U2007A U2007FA
			302023805 U2004 U2007A U2004A U2004FA	302023804 U2008	490062004 U1507	490062002 U2008
LIGHT	FAND DELAY	HI-LIMIT	FAND BLADE	DISCONNECT SW	SOCKET ASSEMBLY	
						
3510-2008-003 U1000A U1000FA U1500A U1500FA	3510-2008-002 U2004A U2004FA U2007A U2007FA	410074000 ALL MODELS	410143000 ALL MODELS	490061001 ALL MODELS	5216-2012-000 ALL MODELS	480108903 ALL MODELS

EFF (F SERIES)						
MOTOR	ELEMENT			DISCONNECT		
						
3900-2002-520 F1500	3900-2002-500 F2004 F2008	302012827 F1500	302012821 F4003	302012811 F4807	410170001 F1500	5216-2019-000 F3003
3900-2002-501 F1507 F2007 F3007 F4007 F4807	F3003 F3006 F4003 F4004 F4006 F4008	302015806 F1507	302012808 F4004	1802-2075-802 F40043	F1507 F2004 F2007 F2008 F3007 F4004 F4007 F4008 F4804 F4807	F3006 F4003 F40043 F4006 F40083 F4803 F48043 F4806 F4808 F48083 F48483LV
3900-2002-518 F40043 F40083 F48043 F4808 F48083	F4008 F4803 F4804 F4806	302015803 F2007	302012822 F4006	1802-2075-800 F40083		
		302015801 F2008	302012807 F4008	1802-2075-801 F4808 F48083		
	3900-2010-000 F48483 F48483LV	302012819 F3003	302012823 F4803	1802-2075-804 F48483 F48483LV		
		302012820 F3006	302012810 F4804			
		302012806 F3007	302012824 F4806			
POWER TR.	SECONDARY TR.	RELAY MODELS BEFORE 2020	RELAY	AUTO LIMIT	HI-LIMIT	FAN DELAY
						
490015017 F3003 F4003 F4803	490065002 F48483LV UNIT MOUNTED T'STAT	5018-2017-000 F40043 F48043 F48483	410101002 F40043 F48043 F48483 F4808 F48083	4520-2048-000 F40043 F48043 F48483 F4808 F48083	410169001 ALL MODELS	410074000 ALL MODELS
490015013 F3006 F4006 F4806		5018-2017-004 F40083 F4808 F48083	410101001 F48483LV			
490015022 F48483 F48483LV	FT1 ASSEMBLY 5813-2028-000 FFT2 ASSEMBLY 5813-2029-000	5018-2017-001 F48483LV			1402-2139-001 ALL MODELS	490030103 ALL MODELS

CDF (500 SERIES)						
ELEMENT	MOTOR	RELAY	OUTLET GRILLE(2 REQ'D)	LOUVER GUIDES NAV W.	LOUVER GUIDES NOR W.	
						
302012802 542	302012813 552	5018-11006-000 542	2501-2020-001 NAVAJO WHITE	1215-2059-000 REA (2 REQ'D)	1215-2059-002 REA (2 REQ'D)	
302012803 547	302012814 557	5018-11006-000 548	2501-2020-002 NORTHERN WHITE	1215-2059-001 SEA (2 REQ'D)	1215-2059-003 SEA (2 REQ'D)	
302012801 548	302012812 558	5018-11006-001 547	GRILLE PANEL	GRILLE PANEL	THERMOSTAT	
		5018-11006-001 557				
FAN DELAY	FAN BLADE	HI-LIMIT	POWER BLOCK	NAVAJO SEB 2016-11147-000 NORTHERN SEBNW 4513-11057-001	NAVAJO REB 4513-11057-001 NORTHERN REBNW 4513-11057-000	500T ALL MODELS
						
1414-2039-000 ALL MODELS	1210-2000-000 ALL MODELS	4520-0011-000 ALL MODELS	5823-0004-000 MODELS NOT ENDING IN A			

* MODELS ENDING IN (A) USE SAME PARTS BUT DO NOT HAVE POWER BLOCKS

CJ900 SERIES



ELEMENTS

MODEL	NO. REQ.	208V	NO. REQ.	240V	NO. REQ.	277V	NO. REQ.	347V	NO. REQ.	380V	NO. REQ.	480V	NO. REQ.	600V
935														
2KW	1	1802-2083-100	1	1802-2083-101	1	1802-2083-114	1	1802-2083-103	1	1802-2083-101	1	1802-2083-114	1	1802-2083-103
3KW	1	1802-2083-107	1	1802-2083-108	1	1802-2083-116	1	1802-2083-105	1	1802-2083-108	1	1802-2083-116	1	1802-2083-105
4KW	1	1802-2083-106	1	1802-2083-107	1	1802-2083-108	1	1802-2083-109	1	1802-2083-107	1	1802-2083-118	1	1802-2083-109
5KW	1	1802-2083-110	1	1802-2083-111	1	1802-2083-120	1	1802-2083-113	1	1802-2083-111	1	1802-2083-120	1	1802-2083-113
6KW	2	1802-2083-107	2	1802-2083-108	2	1802-2083-116	2	1802-2083-105	2	1802-2083-108	2	1802-2083-116	2	1802-2083-105
7KW	1	1802-2083-106	1	1802-2083-107	1	1802-2083-116	1	1802-2083-105	1	1802-2083-107	1	1802-2083-116	1	1802-2083-105
	1	1802-2083-107	1	1802-2083-108	1	1802-2083-118	1	1802-2083-109	1	1802-2083-108	1	1802-2083-118	1	1802-2083-109
8KW	1	1802-2083-107	1	1802-2083-108	1	1802-2083-116	1	1802-2083-105	1	1802-2083-108	1	1802-2083-116	1	1802-2083-105
	1	1802-2083-110	1	1802-2083-111	1	1802-2083-120	1	1802-2083-113	1	1802-2083-111	1	1802-2083-120	1	1802-2083-113
MODEL	NO. REQ.	208V	NO. REQ.	240V	NO. REQ.	277V	NO. REQ.	347V	NO. REQ.	380V	NO. REQ.	480V	NO. REQ.	600V
945														
4KW	2	1802-2083-100	2	1802-2083-101	2	1802-2083-114	2	1802-2083-103	2	1802-2083-101	2	1802-2083-114	2	1802-2083-103
6KW	2	1802-2083-107	2	1802-2083-108	2	1802-2083-116	2	1802-2083-105	2	1802-2083-108	2	1802-2083-116	2	1802-2083-105
8KW	2	1802-2083-106	2	1802-2083-107	2	1802-2083-108	2	1802-2083-109	2	1802-2083-107	2	1802-2083-118	2	1802-2083-109
10KW	2	1802-2083-110	2	1802-2083-111	2	1802-2083-120	2	1802-2083-113	2	1802-2083-111	2	1802-2083-120	2	1802-2083-113
12KW	4	1802-2083-107	4	1802-2083-108	4	1802-2083-116	4	1802-2083-105	4	1802-2083-108	4	1802-2083-116	4	1802-2083-105
14KW	2	1802-2083-106	2	1802-2083-107	2	1802-2083-116	2	1802-2083-105	2	1802-2083-107	2	1802-2083-116	2	1802-2083-105
	2	1802-2083-107	2	1802-2083-108	2	1802-2083-118	2	1802-2083-109	2	1802-2083-108	2	1802-2083-118	2	1802-2083-109
16KW	2	1802-2083-107	2	1802-2083-108	2	1802-2083-116	2	1802-2083-105	2	1802-2083-108	2	1802-2083-116	2	1802-2083-105
	2	1802-2083-110	2	1802-2083-111	2	1802-2083-120	2	1802-2083-113	2	1802-2083-111	2	1802-2083-120	2	1802-2083-113













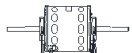

















58" AND LARGER HEATERS CONTACT FACTORY WITH CFID# ON UNIT'S NAMEPLATE





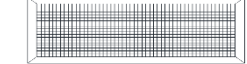
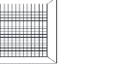







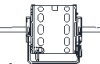



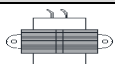

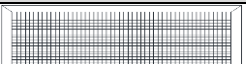

LOUVERED PANELS

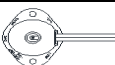
DESERT TAN	35"	4513-2114-T35	NAVAJO WHITE	35"	4513-2114-P35	NORTHERN WHITE	35"	4513-2114-W35	STAT BRONZE	35"	4513-2114-S35
	45"	4513-2114-T45		45"	4513-2114-P45		45"	4513-2114-W45		45"	4513-2114-S45
	58"	4513-2114-T58		58"	4513-2114-P58		58"	4513-2114-W58		58"	4513-2114-S58
	78"	4513-2114-T78		78"	4513-2114-P78		78"	4513-2114-W78		78"	4513-2114-S78
ALUMINUM	35"	4513-2114-A35	BLACK	35"	4513-2114-B35	CHARCOL GREY	35"	4513-2114-G35	BEIGE	35"	4513-2114-N35
	45"	4513-2114-A45		45"	4513-2114-B45		45"	4513-2114-G45		45"	4513-2114-N45
	58"	4513-2114-A58		58"	4513-2114-B58		58"	4513-2114-G58		58"	4513-2114-N58
				78"	4513-2114-B78				78"	4513-2114-N78	

PANEL GRILLES NEW MODELS







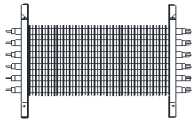
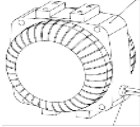

NORTHERN WHITE	35"	2501-11040-000W	BEIGE	35"	2501-11040-000N	BLACK	35"	2501-11040-000B	ALUMINUM	35"	2501-11040-000A
	45"	2501-11040-001W		45"	2501-11040-001N		45"	2501-11040-001B		45"	2501-11040-001A
	68"	2501-11040-003W		68"	2501-11040-003N		68"	2501-11040-003B		68"	2501-11040-003A
	78"	2501-11040-004W		78"	2501-11040-004N		78"	2501-11040-004B		78"	2501-11040-004A
STAT BRONZE	35"	2501-11040-000S									
	45"	2501-11040-001S									
	68"	2501-11040-003S									
	78"	2501-11040-004S									

CU900 CONTINUED						
PRIMARY TRANSFORMER		SEC. TRANSFORMER		MOTORS		BLOWER WHEEL
						
CONTACT FACTORY WITH CFIDI ON UNIT'S NAMEPLATE OR TRANSFORMER LABEL, PART NUMBERS ARE GENERALLY ON THE PART'S LABEL		490026910 MODELS WITH 24V CONTR.		2408/240V 3900-2032-000 277V 3900-2032-001 480V 3900-2032-002 SEE MOTOR LABEL SINGLE SHAFT	2408/240V 3900-2033-000 277V 3900-2033-001 480V 3900-2033-002 SEE MOTOR LABEL DOUBLE SHAFT	490047001 ALL MODELS
DAMPER MOTOR	DAMPER RHEOSTAT	DAMPER RHEOSTAT KNOB	THERMOSTAT SPST	THERMOSTAT 2STG	THERMOSTAT KNOB	PLUG BUTTON
						
3900-2023-000 MODELS WITH AIR DAMPER	410104001 MODELS WITH AIR DAMPER	482084001 MODELS WITH AIR DAMPER	410127001 SINGLE STAGE MODELS	5813-2008-000 TWO STAGE MODELS	3301-2020-001 ALL MODELS	4506-2012-000 ALL MODELS
DAMPER ROCKER SW	FAN AUTO/ON SW	ON/OFF SW	HIGH/LOW SW	DOOR SAFETY SW	AUTO HIGH LIMIT	MANUAL LIMIT
						
410131001 MODELS WITH AIR DAMPER	5216-2029-001 ALL MODELS	5216-2029-001 ALL MODELS	5216-2029-000 SINGLE STAGE MODELS	5216-2028-000 ALL MODELS	4520-2048-000 ALL MODELS	4520-2017-000 ALL MODELS
FAN AUTO RELAY (120V)	FAN DELAY RELAY(120V)	POWER RELAY (120)	FAN AUTO RELAY (24V)	FAN DELAY RELAY (24V)	POWER RELAY (24)	NIGHT SETBACK RELAY
						
410101003 MODELS WITH 120V CONTROL	410171002 MODELS WITH 120V CONTROL	410101003 MODELS WITH 120V CONTROL	410101001 MODELS WITH 24V CONTROL	410171001 MODELS WITH 24V CONTROL	410101001 MODELS WITH 24V CONTROL	410101001 MODELS WITH N.S. RELAY
FUSE	FILTER	FILTER REUSABLE	DISCONNECT SW			
						
481001017 ALL MODELS	2010-7008-006 CU935	2010-7009-006 CU935	30 AMP	5216-2033-000	5216-2033-001	 <i>Optional model with architectural styled grille shown</i>
FUSE HOLDER	2010-7008-007 CU945	2010-7009-007 CU945	60 AMP	5216-2033-001	5216-2033-002	
	2010-7008-008 CU958	2010-7009-008 CU958	100 AMP			
480087001 ALL MODELS	2010-7008-009 CU968	2010-7009-009 CU968				
	2010-7008-010 CU978	2010-7009-010 CU978				

CU 900 SERIES STOCK MODELS						
ELEMENT		MOTOR				TIME DELAY RELAY
						
1802-2083-110 S93505203FFB S94510203FFB	1802-2083-120 S93505483FFB S94510483FFB	3900-2032-000 S93505203FFB S93505243FFB S93505483FFB S93505603FFB	3900-2033-000 S94510203FFB S94510243FFB S94510483FFB S94510603FFB	3900-2032-001 S93505271FFNC 3900-2032-001 S93505483FFNC	3900-2033-001 S94510271FFNC 3900-2033-002 S94510483FFNC	410101001 ALL MODELS
1802-2083-111 S93505243FFB S94510243FFB	S93505271FFNC S93505483FFNC S94510271FFNC					FAN DELAY RELAY 
1802-2083-121 S93505603FFB S94510603FFB	S94510483FFNC					410171001 ALL MODELS
PRI. TRANSFORMER	CAPACITOR		FILTER		FUSE	
						
490015025 S93505483FFB S94510483FFB	490015026 S93505603FFB S94510603FFB	1432-0002-003 S93505203FFB S93505243FFB S93505483FFB S93505603FFB	1432-0002-001 S94510203FFB	2010-7008-006 S93505203FFB S93505243FFB S93505483FFB S93505603FFB	2010-7008-007 S94510203FFB S94510243FFB S94510483FFB S94510603FFB	481001017 ALL MODELS
490026002 S93505271FFNC S94510271FFNC	5814-0003-002 S93505483FFNC S94510483FFNC					FUSE HOLDER 
						480087001 ALL MODELS
SEC. TR (240/24V)	MANUAL RESET	LIMIT	HIGH/LOW SW.	DOOR SW.	FAN AUTO/ON SW.	BLOWER WHEEL
						
490026910 ALL MODELS	4520-2017-000 ALL MODELS	4520-2048-000 ALL MODELS	5216-2029-000 ALL MODELS	5216-2028-000 ALL MODELS	5216-2029-001 ALL MODELS	490047001 ALL MODELS
THERMOSTAT	TSTAT KNOB	PLUG BUTTON				
						
410127001 ALL MODELS	3301-2020-001 ALL MODELS	4506-2012-000 ALL MODELS				





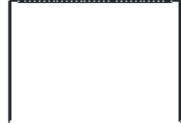

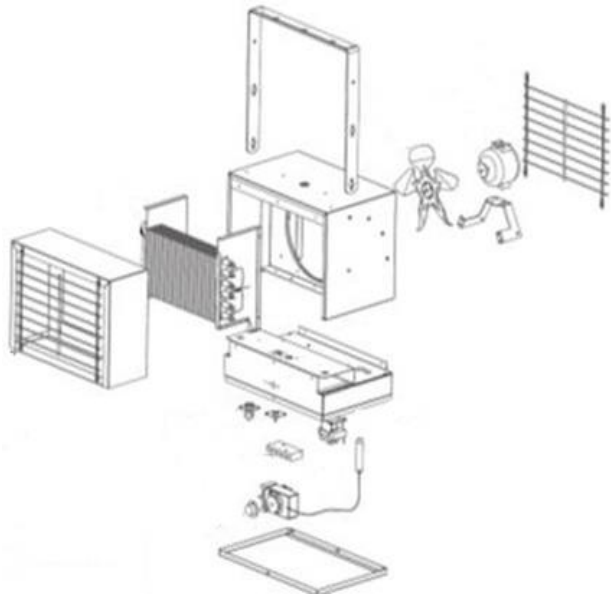





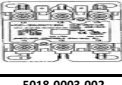





COMPACT FREEZE PROTECTION HEATERS PHFP25





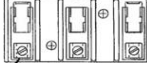







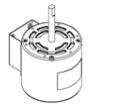
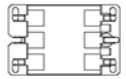
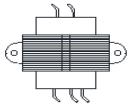



ELEMENT	MOTOR	FAN BLADE	FAN RELAY	RELAY
				
1802-11002-000 CHPR25	3900-11007-001 CHPR25	1210-2017-000 CHPR25	410171003 CHPR25	1414-2038-000 CHPR25
THERMOSTAT	KNOB	HI LIMIT	POWER BLOCK	MT. BRACKET
				
5813-2091-000 CHPR25	3301-2053-000 CHPR25	1414-2037-000 CHPR25	5823-0004-005 CHPR25	310876001 CHPR25

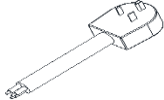

IUH SERIES

ELEMENT			FAN BLADE		MOTOR		RELAY			
										
302006804 UH520 UH520A	302006811 UH727 UH727A	302006842 UH1534 UH1560	1210-2017-000 UH520 UH520A UH524 UH524A	490011001 UH1020 UH1024 UH1027 UH1034 UH1048 UH1060 UH1520 UH1524 UH1527 UH1534 UH1548 UH1560A UH720 UH720A UH724 UH724A UH727 UH727A UH734 UH734A UH748 UH1060 UH2034 UH2060	3900-2008-000 UH520 UH520A UH524 UH534 UH534A UH538 UH538A UH548 UH548A UH560 UH720 UH720A UH724 UH724A UH748 UH748A	490059004 UH1020 UH1024 UH1027 UH1034 UH1048 UH1060 UH1520 UH1524 UH1527 UH1534 UH1548 UH1560 UH720 UH720A UH724 UH724A UH748 UH748A	5018-0004-102 UH520A UH524A UH538 UH538A UH548 UH548A UH560 UH720 UH724 UH748 UH748A UH760 UH760A UH1034	5018-0003-002 UH534 UH534A UH734 UH734A UH1534	5018-0005-006 UH1020 UH1024 UH1027 UH1048 UH1060 UH1520 UH1524 UH1527 UH1548 UH1560 UH2034 UH2048 UH2060 UH2548 UH2560 UH3048 UH3060	
302006807 UH524 UH524A UH548 UH548A	302006840 UH734 UH734A UH760 UH760A	302006829 UH2548 302006843 UH2560 302006822 UH3048 302006844 UH3060	UH534 UH534A UH538 UH538A UH548 UH548A UH560 UH720 UH720A UH724 UH724A UH727 UH727A UH734 UH734A UH748 UH1060 UH2034 UH2060	UH1027 UH1034 UH1048 UH1060 UH1520 UH1524 UH1527 UH1534 UH1548 UH1560 UH720 UH720A UH724 UH724A UH748 UH748A UH760 UH760A	UH524 UH524A UH534 UH534A UH538 UH538A UH548 UH548A UH560 UH720 UH720A UH724 UH724A UH748 UH748A	UH1027 UH1034 UH1048 UH1060 UH1520 UH1524 UH1527 UH1534 UH1548 UH1560 UH720 UH720A UH724 UH724A UH748 UH748A	UH538A UH548 UH548A UH560 UH720 UH720A UH724 UH724A UH748 UH748A	UH534 UH534A UH734 UH734A UH1534	UH1027 UH1048 UH1060 UH1520 UH1524 UH1548 UH1560 UH2034 UH2048 UH2060 UH2548 UH2560 UH3048 UH3060	
302006839 UH534 UH534A UH560 UH560A	302006812 UH1020 UH1527 302006813 UH1024 UH1048 UH1520 UH2048	UH3048 UH3060	UH538 UH538A UH548 UH548A UH560 UH720 UH720A UH724 UH724A UH727 UH727A UH734 UH734A UH748 UH1060 UH2034 UH2060	UH1520 UH1524 UH1527 UH1534 UH1548 UH1560 UH720 UH720A UH724 UH724A UH748 UH748A UH760 UH760A	UH524 UH524A UH534 UH534A UH538 UH538A UH548 UH548A UH560 UH720 UH720A UH724 UH724A UH748 UH748A	UH1027 UH1034 UH1048 UH1060 UH1520 UH1524 UH1527 UH1534 UH1548 UH1560 UH720 UH720A UH724 UH724A UH748 UH748A	UH538A UH548 UH548A UH560 UH720 UH720A UH724 UH724A UH748 UH748A	UH534 UH534A UH734 UH734A UH1534	UH1027 UH1048 UH1060 UH1520 UH1524 UH1548 UH1560 UH2034 UH2048 UH2060 UH2548 UH2560 UH3048 UH3060	
302006848 UH538 UH538A	UH1048 UH1520 UH2048		UH724 UH727 UH727A UH734 UH734A UH748 UH748A UH760 UH760A	UH1520 UH1524 UH1527 UH1534 UH1548 UH1560 UH720 UH720A UH724 UH724A UH748 UH748A UH760 UH760A	UH524 UH524A UH534 UH534A UH538 UH538A UH548 UH548A UH560 UH720 UH720A UH724 UH724A UH748 UH748A	UH1027 UH1034 UH1048 UH1060 UH1520 UH1524 UH1527 UH1534 UH1548 UH1560 UH720 UH720A UH724 UH724A UH748 UH748A	UH538A UH548 UH548A UH560 UH720 UH720A UH724 UH724A UH748 UH748A	UH534 UH534A UH734 UH734A UH1534	UH1027 UH1048 UH1060 UH1520 UH1524 UH1548 UH1560 UH2034 UH2048 UH2060 UH2548 UH2560 UH3048 UH3060	
302006809 UH720 UH720A	302006814 UH1027 UH1524 UH1548		UH724 UH727 UH727A UH734 UH734A UH748 UH748A UH760 UH760A	UH1520 UH1524 UH1527 UH1534 UH1548 UH1560 UH720 UH720A UH724 UH724A UH748 UH748A UH760 UH760A	UH524 UH524A UH534 UH534A UH538 UH538A UH548 UH548A UH560 UH720 UH720A UH724 UH724A UH748 UH748A	UH1027 UH1034 UH1048 UH1060 UH1520 UH1524 UH1527 UH1534 UH1548 UH1560 UH720 UH720A UH724 UH724A UH748 UH748A	UH538A UH548 UH548A UH560 UH720 UH720A UH724 UH724A UH748 UH748A	UH534 UH534A UH734 UH734A UH1534	UH1027 UH1048 UH1060 UH1520 UH1524 UH1548 UH1560 UH2034 UH2048 UH2060 UH2548 UH2560 UH3048 UH3060	
302006810 UH724 UH724A UH748 UH748A	302006841 UH1034 UH1060 UH2034 UH2060		UH724 UH727 UH727A UH734 UH734A UH748 UH748A UH760 UH760A	UH1520 UH1524 UH1527 UH1534 UH1548 UH1560 UH720 UH720A UH724 UH724A UH748 UH748A UH760 UH760A	UH524 UH524A UH534 UH534A UH538 UH538A UH548 UH548A UH560 UH720 UH720A UH724 UH724A UH748 UH748A	UH1027 UH1034 UH1048 UH1060 UH1520 UH1524 UH1527 UH1534 UH1548 UH1560 UH720 UH720A UH724 UH724A UH748 UH748A	UH538A UH548 UH548A UH560 UH720 UH720A UH724 UH724A UH748 UH748A	UH534 UH534A UH734 UH734A UH1534	UH1027 UH1048 UH1060 UH1520 UH1524 UH1548 UH1560 UH2034 UH2048 UH2060 UH2548 UH2560 UH3048 UH3060	
LIGHT	FUSE BLOCK	FUSE	CAPACITOR	HI LIMIT	FAN DELAY	TRANSFORMER				
										
3510-2017-003 UH524A UH724A	480099002 UH1020 UH1024 UH1520 480099003 UH1520 UH1524 480096000 UH1527 480099001 UH1534 UH2034 2025-0001-000 UH2034	481001003 UH1020 UH1024 UH1520 UH1534 UH2034 481001006 UH1520 UH1524 481001023 UH1527 2019-7002-007 UH2034	1432-0002-003 UH2548 UH2560 UH3048 UH3060	410027000 ALL MODELS	410148000 ALL MODELS	490015017 UH534 UH534A UH734 UH734A 490015014 UH538 UH538A 490056001 UH548 UH548A UH748 UH748A	490015013 UH560 UH560A UH760 UH760A 490015009 UH1027 UH1527 490015019 UH1034 UH1534 UH2034	490015010 UH1048 UH1548 UH2048 490015012 UH1060 UH1560 UH2060 490015008 UH2548 UH3048 490015015 UH2560 UH3060		
QUANTITY 5 & 7.5KW (4) 10 THRU 20KW (6) 25 & 30KW (9)	LOUVER	LOUVER SPRING	HOLE PLUG	MT. BRACKET	POWER BLOCK		THERMOSTAT (ASSM INCLUDES KNOB)			
										
3503-2004-109 UH520 UH520A UH524 UH524A UH534 UH534A UH538 UH538A UH548 UH548A UH560 UH560A UH720 UH720A UH724 UH724A UH727 UH727A UH734 UH734A UH748 UH748A UH760 UH760A	3503-2004-111 UH1020 UH1024 UH1027 UH1034 UH1048 UH1060 UH1520 UH1524 UH1527 UH1534 UH1548 UH1560 UH2034 UH2048 UH2060	3503-2004-112 UH2548 UH2560 UH3048 UH3060	5208-7005-001 ALL MODELS	29214-11621 UH520 UH520A UH524 UH524A UH534 UH534A UH538 UH538A UH548 UH548A UH560 UH560A UH720 UH720A UH724 UH724A UH727 UH727A UH734 UH734A UH748 UH748A UH760 UH760A	310876001 UH520 UH520A UH524 UH524A UH534 UH534A UH538 UH538A UH548 UH548A UH560 UH560A UH720 UH720A UH724 UH724A UH727 UH727A UH734 UH734A UH748 UH748A UH760 UH760A	5823-0004-000 UH520 UH520A UH524 UH524A UH534 UH534A UH538 UH538A UH548 UH548A UH560 UH560A UH720 UH720A UH724 UH724A UH727 UH727A UH734 UH734A UH748 UH748A UH760 UH760A 5823-0004-005 UH734 UH734A	480100001 UH1020 UH1024 UH1027 UH1034 UH1048 UH1060 UH1520 UH1524 UH1527 UH1534 UH1548 UH1560 UH2034 UH2048 UH2060 480034002 UH2548 UH2560 UH3048 UH3060			

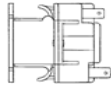
MEDH SERIES

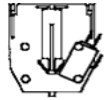
ELEMENT SMALL		ELEMENT LARGE		MOTOR		CONTACTOR		TRANSFORMER	
									
1802-11001-000 DH1583CKD		1802-11001-001 DH1583CKD		3900-11002-000 DH1583CKD DH1021CKD DH1021D DH1521D DH1523D		5018-0006-007 DH1583CKD DH1521D DH1523D		5018-0006-009 DH1543CKD DH3043D	
1802-11001-002 DH1021CKD DH1021D DH1521D DH1523D DH1543CKD DH3043D		1802-11001-003 DH1021CKD DH1021D DH1521D DH1523D DH1543CKD DH3043D		3900-11002-001 DH1543CKD DH3043D					
FAN BLADE		HI LIMIT		THERMOSTAT		CAPACITOR		GUARDS QTY. 2 NEEDED	
									
1210-0098-001 ALL MODELS		410029000 ALL MODELS		5813-2059-000 ALL MODELS		1432-0002-003 ALL MODELS		2504-11005-000 ALL MODELS	
HANDLE		CART KNOB		THERMOSTAT KNOB		WHEEL		SHAFT CAP	
									
2710-11001-000 ALL MODELS		3301-11003-000 ALL MODELS		3301-11018-002 ALL MODELS		6406-0002-000 ALL MODELS		1408-11002-000 ALL MODELS	
CORD		FUSE		FUSE BLOCK		FAN RELAY		FAN DELAY	
									
SCS25064 DH1583CKD SCS10063 DH1021CKD SCS25124 DH1543CKD		2019-7008-077 DH1521D		480030007 DH1521D		5018-0007-000 DH1543CKD DH3043D		1414-2039-000 DH3043D	
								5217-11001-000 ALL MODELS	
								AUXILIARY SWITCH	
									
								5216-10564-000 DH1521D	

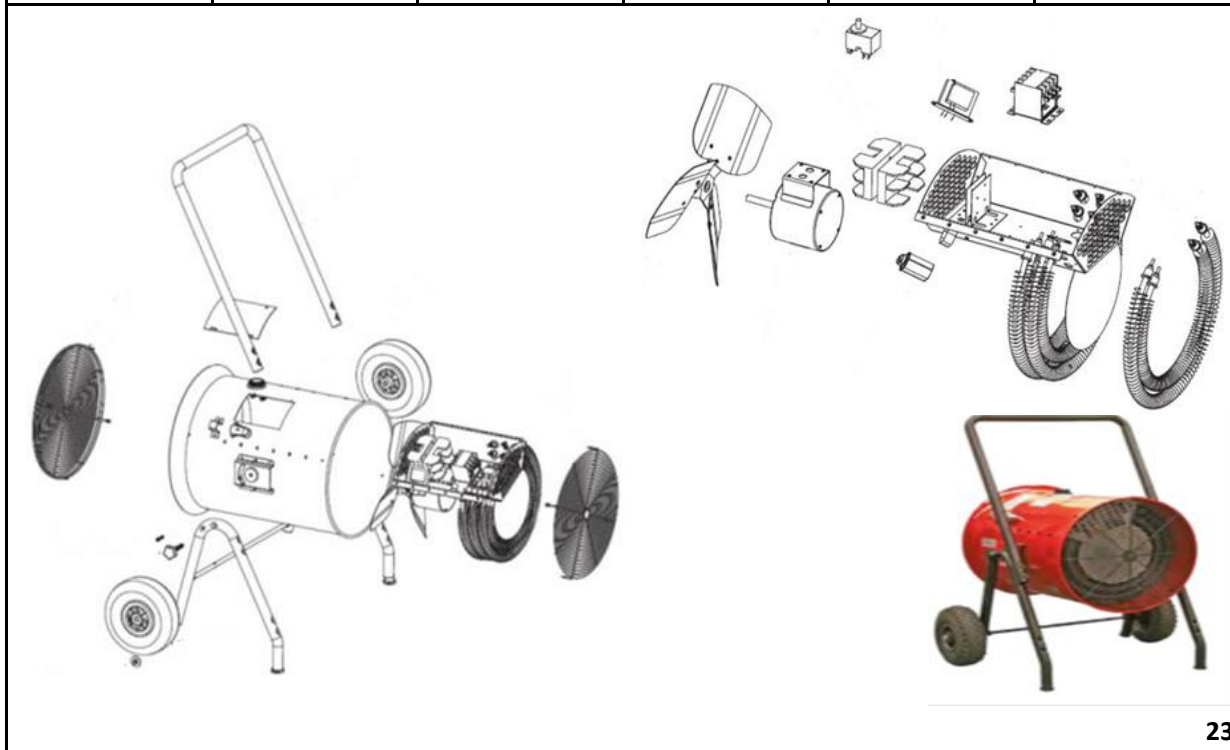

MSDH

MODEL	ELEMENT (11)	ELEMENT (12)	MOTOR (16)	CONTACTOR (20)
SDH3043	118-304793-011 (3)	118-304793-013 (3)	193-121843-232	072-304551-008
SDH3093	118-304793-012 (3)	118-304793-014 (3)	193-121843-233	072-304551-008
SDH4843	118-304793-011 (3)	118-304793-013 (6)	193-121843-232	072-304551-008 (2)
SDH4893	118-304793-012 (3)	118-304793-014 (6)	193-121843-233	072-304551-008 (2)
SDH6043	118-304793-011 (6)	118-304793-013 (6)	193-121843-232	072-304551-008 (2)
SDH6093	118-304793-012 (6)	118-304793-014 (6)	193-121843-233	072-304551-008 (2)
MODEL	TRANSFORMER (21)	FUSE BLOCK (80)	FUSE (81)	TERM. BLOCK (84)
SDH3043	315-304252-001	NA	NA	NA*
SDH3093	315-304252-003	NA	NA	NA*
SDH4843	315-304252-001	129-025643-001	128-026510-005 (3)	303-047468-004
SDH4893	315-304252-003	129-025643-001	128-026510-005 (3)	303-047468-004
SDH6043	315-304252-001	129-025643-001 (2)	128-026510-006 (6)	303-047468-004
SDH6093	315-304252-003	129-025643-001 (2)	128-026510-006 (6)	303-047468-004

PARTS COMMON TO ALL UNITS

TEMPERATURE CONTROL (18)	300-019560-002
HI-LIMIT (19)	300-049200-004
TOGGLE SWITCH (23)	292-046123-001
BLOWER ASSEMBLY (32)	021-304823-009
INLET & OUTLET GRILLE (33)	134-304780-002 (2)
CASTER/LOCKING (36)	375-122535-007
HANDLE-RIGHT SIDE (37)	139-304779-003
HANDLE-LEFT SIDE (38)	139-304479-004
SEMI-PNEUMATIC WHEEL (45)	333-557518-004 (2)
PULLEY VAR. PITCH 7/8" (77)	225-305091-004
PULLEY VAR. PITCH 5/8" (78)	225-305091-003
PULLEY BELT (79)	017-049702-009
PILOT LIGHT-GREEN (86)	213-122066-043
PILOT LIGHT-AMBER (87)	213-122066-042
THERMOSTAT KNOB (94)	169-017949-004

NOTES:
 (#) QUANTITY REQ.
 * WIRED DIRECTLY TO CONTACTOR

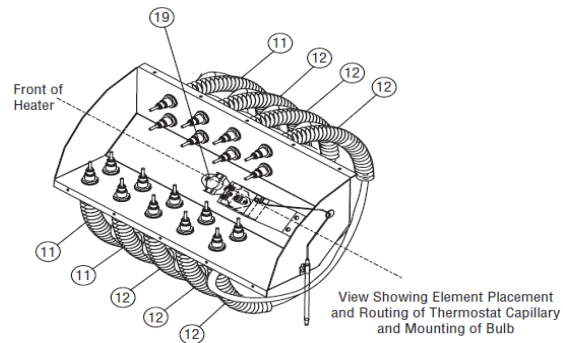
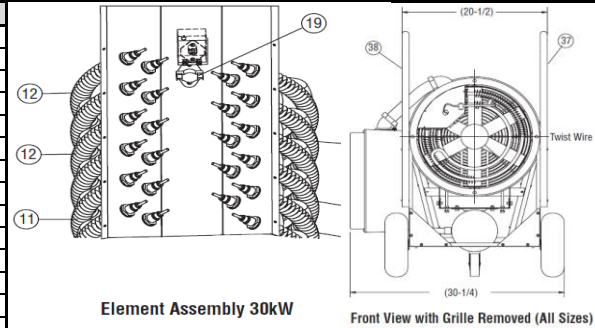



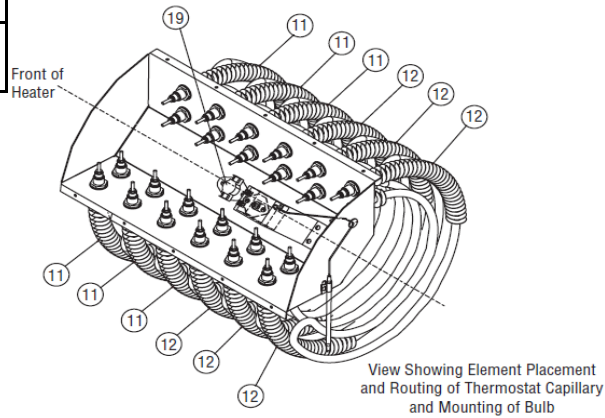



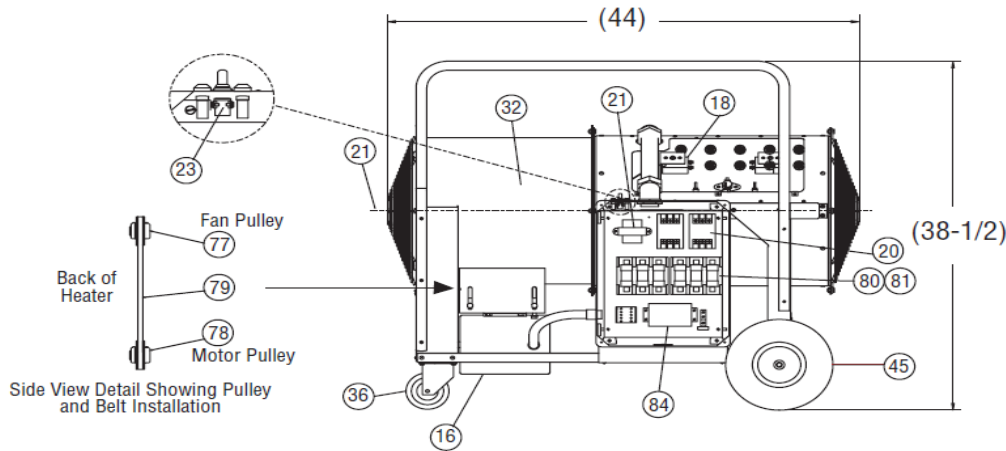

Element Assembly 48kW

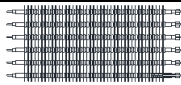
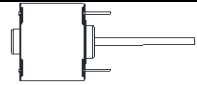
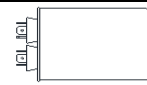

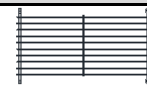

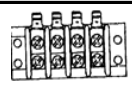
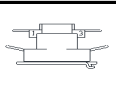
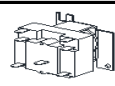

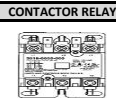

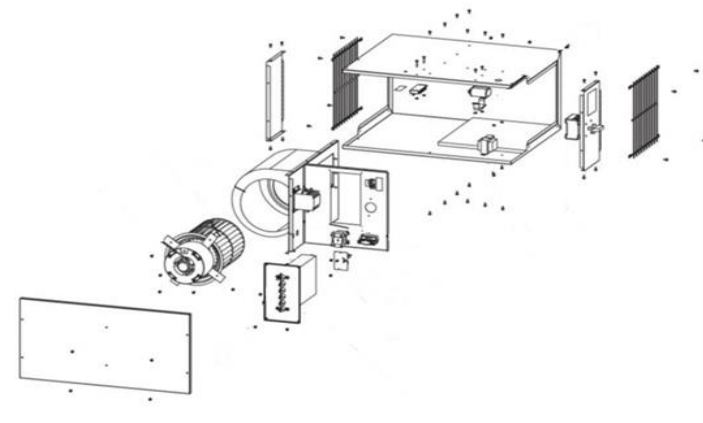





Element Assembly 60kW



Side View shown with Heater and Control Terminal Box Covers Removed All Sizes





MSPH PLENUM RATED UNIT HEATER								
ELEMENT			MOTOR			CAPACITOR		
								
1802-10498-000 PRH1381240000 PRH1383240000	1802-10498-004 PRH11021240000 PRH11023240000	1802-10498-007 PRH1343240000 1802-10498-008 PRH11583240000 PRH17581240000 PRH17583240000	3900-10164-001 PRH11043240000 PRH11543240000 PRH1343240000 PRH1543240000 PRH17543240000 PRH21043240000 PRH21543240000	3900-10160-003 PRH11021240000 PRH11023240000 PRH1083240000 PRH11523240000 PRH1583240000 PRH1521240000 PRH1523240000 PRH1581240000 PRH1581240000 PRH1583240000 PRH1581240000 PRH1583240000 PRH1571240000 PRH17523240000 PRH17581240000 PRH17583240000 PRH21021240000 PRH21043240000 PRH21023240000 PRH21083240000 PRH21523240000	3900-2094-001 PRH1321240000 PRH1323240000 PRH1381240000 PRH1383240000 PRH1521240000 PRH1523240000 PRH1581240000 PRH1583240000 3900-2095-001 PRH11071240000 PRH11521240000 PRH1521240000 PRH1571240000	1432-0002-001 PRH11043240000 PRH11071240000 PRH11543240000 PRH1321240000 PRH1323240000 PRH1343240000 PRH1371240000 PRH1381240000 PRH1383240000 PRH1521240000 PRH1523240000 PRH17543240000 PRH17571240000 PRH21043240000 PRH21071240000 PRH21543240000		1432-0002-002 PRH11021240000 PRH11023240000 PRH11083240000 PRH11523240000 PRH1583240000 PRH1521240000 PRH1581240000 PRH1581240000 PRH1583240000 PRH17521240000 PRH17523240000 PRH17581240000 PRH17583240000 PRH21021240000 PRH21023240000 PRH21083240000 PRH21523240000
BLOWER ASSEMBLY			LIMIT			GRILLE		
								
1225-10158-000 PRH11021240000 PRH11023240000 PRH11043240000 PRH1071240000 PRH11083240000 PRH11523240000 PRH11543240000 PRH11583240000 PRH1521240000 PRH1523240000 PRH153240000 PRH1571240000 PRH1581240000 PRH1583240000	1225-2022-000 PRH17521240000 PRH17523240000 PRH17543240000 PRH17571240000 PRH17581240000 PRH17583240000 PRH21021240000 PRH21023240000 PRH21043240000 PRH21071240000 PRH21083240000 PRH21523240000 PRH21543240000	1414-2040-001 PRH11021240000 PRH11023240000 PRH11043240000 PRH1071240000 PRH11083240000 PRH11523240000 PRH11543240000 PRH11583240000 PRH1521240000 PRH1523240000 PRH153240000 PRH1571240000 PRH1581240000 PRH1583240000	1414-2040-000 PRH1321240000 PRH1323240000 PRH1343240000 PRH1371240000 PRH1381240000 PRH1383240000 PRH1383240000 PRH1521240000 PRH1523240000 PRH1543240000 PRH1571240000 PRH1581240000 PRH1583240000	2501-10156-800 PRH11021240000 PRH11023240000 PRH11043240000 PRH1071240000 PRH11083240000 PRH11523240000 PRH11543240000 PRH11583240000 PRH1521240000 PRH1523240000 PRH153240000 PRH1571240000 PRH1581240000 PRH1583240000	312056803 PRH1321240000 PRH1323240000 PRH1343240000 PRH1371240000 PRH1381240000 PRH1383240000 PRH1521240000 PRH1523240000 PRH1543240000 PRH1571240000 PRH1581240000 PRH1583240000			
TRANSFORMER			TERMINAL BLOCK			TIME DELAY RELAY	FAN RELAY	DISCONNECT SW.
								
5814-0003-000 PRH11021240000 PRH11023240000 PRH11083240000 PRH11523240000 PRH11583240000 PRH1321240000 PRH1323240000 PRH1381240000 PRH1383240000 PRH1521240000 PRH1523240000 PRH153240000	5814-0003-001 PRH11071240000 PRH11571240000 PRH11583240000 PRH17571240000 PRH21071240000 5814-0003-002 PRH11043240000 PRH11543240000 PRH1343240000 PRH1543240000 PRH1543240000 PRH17543240000 PRH21043240000 PRH21543240000	480106001 PRH11021240000 PRH11023240000 PRH11043240000 PRH1071240000 PRH11083240000 PRH11523240000 PRH11543240000 PRH11583240000 PRH1321240000 PRH1323240000 PRH1343240000 PRH1371240000 PRH1381240000 PRH1383240000 PRH1521240000	480106002 PRH1523240000 PRH1523240000 PRH1543240000 PRH1571240000 PRH1571240000 PRH1581240000 PRH1581240000 PRH1583240000 PRH17521240000 PRH17523240000 PRH17543240000 PRH17571240000 PRH17581240000 PRH17583240000	410171001 ALL MODELS 5018-2024-000 ALL MODELS 5216-2036-000 ALL MODELS	410171001 ALL MODELS 5018-2024-000 ALL MODELS 5216-2036-000 ALL MODELS	 5018-0005-004 ALL MODELS 		
								



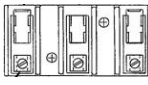

MUH SERIES

ELEMENT				MOTOR			CAPACITOR
QUANTITY OF ELEMENTS 3 THRU 10KW (3) 15 THRU 30KW (6) 40 & 50KW (9) 							
1802-0087-000 MUH0321 1802-0087-040 MUH0331 1802-0087-002 MUH0341 1802-2073-000 MUH0361 1802-0087-001 MUH0371 1802-0087-024 MUH0381 1802-0087-035 MUH0521 1802-0087-003 MUH0521MG 1802-0087-041 MUH0531 1802-0087-005 MUH0541 1802-2073-001 MUH0561	1802-0087-004 MUH0571 1802-0087-034 MUH0581 1802-0087-025 MUH0581MG 1802-0087-006 MUH072 1802-0087-042 MUH073 1802-0087-008 MUH074 1802-2073-002 MUH076 1802-0087-007 MUH077 1802-0087-031 MUH078 MUH102 1802-0087-044 MUH103 MUH106 MUH206	1802-0087-011 MUH104 1802-0087-010 MUH107 1802-0087-036 MUH108 1802-0087-012 MUH152 1802-0087-008 MUH154 1802-2073-002 MUH156 1802-0087-037 MUH158 MUH202 1802-0087-026 MUH208 1802-0087-016 MUH252 1802-0087-017 MUH254 MUH254A	1802-0087-046 MUH256 1802-0087-018 MUH302 1802-0087-019 MUH304 MUH304A 1802-0087-047 MUH306 1802-0087-028 MUH308 1802-0087-020 MUH402 1802-0087-021 MUH404 1802-0087-048 MUH406 1802-0087-022 MUH502 1802-0087-023 MUH504 1802-0087-049 MUH506 1802-0087-030 MUH508	3900-2002-506 MUH0321 MUH0381 MUH0521 MUH0521MG MUH0581 MUH0581MG 3900-2002-516 MUH0331 MUH0361 MUH0531 MUH0561 3900-2005-000 MUH0341 MUH0541 3900-2002-507 MUH0371 MUH0571 3900-0347-005 MUH074 MUH104 3900-0361-500 MUH152 MUH158	3900-2014-004 MUH072 MUH073 MUH076 MUH077 MUH078 MUH102 MUH103 MUH106 MUH107 MUH108 3900-0361-501 MUH154 3900-0361-003 MUH156 3900-0362-000 MUH202 MUH206 3900-0362-001 MUH204 MUH208 3900-0362-002 MUH208	3900-0364-000 MUH252 MUH256 MUH302 MUH306 MUH308 3900-0363-500 MUH254 MUH304 3900-0363-500 MUH254A MUH304A 3900-0350-000 MUH402 MUH502 MUH506 3900-0350-001 MUH404 MUH406 MUH504 3900-0350-000 MUH508	1432-0002-003 MUH202 MUH204 MUH206 MUH208 MUH252 MUH254 1432-11004-000 MUH254A MUH304A 1432-0002-001 MUH308 1432-0002-004 MUH402 MUH404 MUH406 MUH502 MUH504 MUH506 MUH508
PROTECTOR LIMIT		FAN DELAY		FAN BLADE		HI/LOW SP. SWITCH	
							
4520-0011-000 MUH0321 MUH0331 MUH0341 MUH0361 MUH0371 MUH0381 MUH0521 MUH0521MG MUH0531 MUH0541 MUH0561 MUH0571 MUH0581 MUH0581MG	4520-0011-001 MUH072 MUH073 MUH074 MUH076 MUH077 MUH078 MUH102 MUH103 MUH104 MUH106 MUH107 MUH108 MUH152 MUH154 MUH156 MUH158 MUH202 MUH204 MUH206 MUH208	4520-0011-002 MUH252 MUH254 MUH254A MUH256 MUH302 MUH304 MUH304A MUH306 MUH308 MUH402 MUH404 MUH406 MUH502 MUH504 MUH506 MUH508	4520-0010-000 ALL MODELS	1210-2000-000 MUH0321 MUH0331 MUH0341 MUH0361 MUH0371 MUH0381 MUH0521 MUH0521MG MUH0531 MUH0541 MUH0561 MUH0571 MUH0581 MUH0581MG	1210-0090-000 MUH072 MUH073 MUH074 MUH076 MUH077 MUH078 MUH102 MUH103 MUH104 MUH106 MUH107 MUH108 1210-0090-001 MUH152 MUH154 MUH156 MUH158 1210-0096-000 MUH202 MUH204 MUH206 MUH208	1210-0098-000 MUH252 MUH254 MUH254A MUH256 MUH302 MUH304 MUH304A MUH306 MUH308 1210-11004-000 MUH402 MUH404 MUH406 MUH502 MUH504 MUH506 MUH508	5216-2053-000 MUH252 MUH254 MUH254A MUH256 MUH302 MUH304 MUH304A MUH306 MUH308 MUH402 MUH404 MUH406 MUH502 MUH504 MUH506 MUH508
RELAY				POWER TR		SECONDARY TR	
							
30 AMP 5018-0003-000 MUH0331 MUH0531 MUH073 MUH077 MUH103 MUH107 30 AMP 5018-0003-002 MUH0521MG MUH0581MG	35 AMP 5018-0004-100 MUH0341 MUH0361 MUH0541 MUH0561 MUH074 MUH076 MUH104 MUH106 MUH154 MUH206 MUH256 MUH306 MUH506	40 AMP 5018-0005-004 MUH072 MUH078 MUH102 MUH108 MUH152 MUH158 MUH204 MUH208 MUH252 MUH254 MUH254A MUH302 MUH304 MUH304A MUH402 MUH404 MUH406 MUH502 MUH506 40 AMP 5018-10562-004 MUH402 MUH502 MUH508	50 AMP 5018-0006-000 MUH202 MUH308 MUH504 MUH508	240/208V PR TO 24V SEC 5814-0003-000 MUH072 MUH078 MUH102 MUH103 MUH108 MUH152 MUH158 MUH202 MUH208 MUH252 MUH302 MUH308 277V PR TO 24V SEC 5814-0003-001 MUH077 MUH107 240V/208V PR TO 24V SEC 490026007 MUH402 MUH502 MUH508	480V PR TO 24V SEC 5814-0003-002 MUH0341 MUH0541 MUH074 MUH104 MUH154 MUH204 MUH254 MUH254A MUH304 MUH304A MUH404 MUH504 600V PR TO 24V SEC 490015012 MUH106 MUH156 MUH206 MUH256 MUH306	600V PR TO 240V SEC 490015013 MUH0361 MUH0561 600V PR TO 240V SEC 490015015 MUH406 MUH502 MUH504 MUH506 MUH508 347V PR TO 240V SEC 490015017 MUH0331 MUH0531 347V PR TO 240V SEC 490015018 MUH073 MUH103 600V PR TO 240V SEC 490015021 MUH076	240/208V PR TO 24V SEC 5814-0003-000 MUH0331 MUH0361 MUH0531 MUH0561 MUH073 MUH076 MUH106 MUH108 MUH156 MUH206

PRO AND PRO-SSP CONTINUE NEXT PAGE













MUH CONTINUED

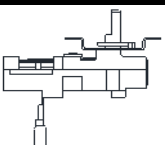
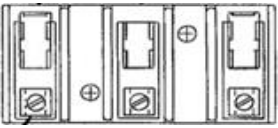
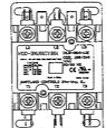

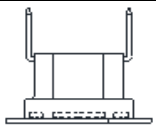

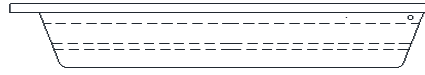





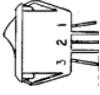

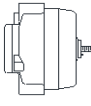

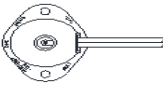
CONTROL BOARD		POWER BLOCK			
					
5823-0001-000	5823-0002-000	5823-0004-000	5823-0004-001	5823-0004-002	5823-0004-003
MUH0321 MUH0371 MUH0381 MUH0521 MUH0571 MUH0581	MUH0331 MUH0341 MUH0361 MUH0521MG MUH0531 MUH0541 MUH0561 MUH0581MG MUH072 MUH073 MUH074 MUH076 MUH077 MUH078 MUH102 MUH103 MUH104 MUH106 MUH107 MUH108 MUH152 MUH154 MUH156 MUH158	MUH202 MUH204 MUH206 MUH208 MUH252 MUH254 MUH254A MUH256 MUH302 MUH304 MUH304A MUH306 MUH308 MUH402 MUH404 MUH406 MUH502 MUH504 MUH506 MUH508	MUH0381-PRO MUH0321-PRO MUH0341-PRO MUH0581-PRO MUH0521-PRO MUH0541-PRO MUH078-PRO MUH072-PRO MUH074-PRO MUH108-PRO MUH102-PRO MUH104-PRO MUH0381-PRO-SSP MUH0321-PRO-SSP MUH0341-PRO-SSP MUH0581-PRO-SSP MUH0521-PRO-SSP MUH0541-PRO-SSP MUH078-PRO-SSP MUH072-PRO-SSP MUH074-PRO-SSP MUH108-PRO-SSP MUH102-PRO-SSP MUH104-PRO-SSP	MUH0321 MUH0331 MUH0341 MUH0361 MUH0371 MUH0381 MUH0521MG MUH0531 MUH0541 MUH0561 MUH0571 MUH0581MG MUH073 MUH074 MUH076 MUH077 MUH078	MUH102 MUH103 MUH104 MUH106 MUH107 MUH108 MUH154 MUH204 MUH206 MUH254 MUH306
			MUH152 MUH254 MUH254A MUH304 MUH304A	MUH202 MUH208 MUH252 MUH404 MUH406 MUH504 MUH506	MUH158 MUH302
				5823-0005-000	
				MUH308 MUH402 MUH502 MUH508	



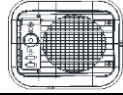





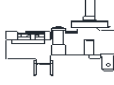
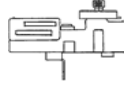

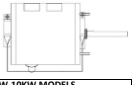
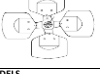

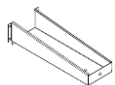
LOUVERS		LOUVER SPRING	FUSE BLOCK	FUSE	THERMOSTAT (ASSM INCLUDES KNOB)	
QUANTITY 385KW (5) 7 THRU 20KW (6) 25 THRU 50KW (9)					UHM1T1 (ASSEMBLY 1-POLE) 5813-0036-000 THERMOSTAT 3301-2020-006 KNOB UHM2T2 (ASSEMBLY 2-STAGE) 5813-0035-000 THERMOSTAT 3301-2020-006 KNOB UHM1T1-S (ASSEMBLY 1-POLE) 5813-0038-003 THERMOSTAT 3301-2020-006 KNOB	
3503-2004-106	3503-2004-107	3503-2004-108	5208-7005-001 ALL MODELS	2025-0002-000 MUH158 MUH208 480030004 MUH252 MUH302 MUH308 MUH402 MUH502 MUH508 2025-0001-000 MUH504 MUH506 2025-7004-000 MUH504 MUH506	2019-0007-010 MUH158 2019-0007-008 MUH208 2019-7008-077 MUH252 2019-7008-079 MUH302 MUH502 2019-7008-080 MUH308 MUH508 2019-7008-078 MUH402 2019-7002-008 MUH504 2019-7002-007 MUH506 2019-7002-012 MUH504 2019-7002-011 MUH506	
MUH0321 MUH0331 MUH0341 MUH0361 MUH0371 MUH0381 MUH0521 MUH0521MG MUH0531 MUH0541 MUH0561 MUH0571 MUH0581 MUH0581MG	MUH072 MUH073 MUH074 MUH076 MUH077 MUH078 MUH102 MUH103 MUH104 MUH106 MUH107 MUH108 MUH152 MUH154 MUH156 MUH158 MUH202 MUH204 MUH206 MUH208	MUH252 MUH254 MUH254A MUH256 MUH302 MUH304 MUH304A MUH306 MUH308 MUH402 MUH404 MUH406 MUH502 MUH504 MUH506 MUH508				

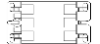
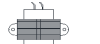
SAME PARTS AS STOCK MODELS WITH ADDED DISCONNECT SWITCH, THERMOSTAT, & 24V CONTROL CIRCUIT				
MODEL	DISCONNECT SWITCH	THERMOSTAT	TRANSFORMER	RELAY
MUH0381-PRO	5216-2036-000	UHM1T1	5814-0003-000	5018-0003-000
MUH0321-PRO	5216-2036-000	UHM1T1	5814-0003-000	5018-0003-000
MUH0341-PRO	5216-2036-000	UHM1T1	5814-0003-002	5018-0004-100
MUH0581-PRO	5216-2036-000	UHM1T1	5814-0003-000	5018-0003-000
MUH0521-PRO	5216-2036-000	UHM1T1	5814-0003-000	5018-0003-000
MUH0541-PRO	5216-2036-000	UHM1T1	5814-0003-002	5018-0004-100
MUH078-PRO	5216-2039-000	UHM1T1	5814-0003-000	5018-0003-000
MUH072-PRO	5216-2039-000	UHM1T1	5814-0003-002	5018-0003-000
MUH074-PRO	5216-2039-000	UHM1T1	5814-0003-000	5018-0004-100
MUH108-PRO	5216-2039-000	UHM1T1	5814-0003-000	5018-0003-000
MUH102-PRO	5216-2039-000	UHM1T1	5814-0003-002	5018-0004-100
MUH104-PRO	5216-2036-000	UHM1T1	5814-0003-002	5018-0004-100
MODEL	DISCONNECT SWITCH	THERMOSTAT	TRANSFORMER	RELAY
MUH0381-PRO-SSP	5216-2036-000	1414-11050-000	5814-0003-000	5018-0003-000
MUH0321-PRO-SSP	5216-2036-000	1414-11050-000	5814-0003-000	5018-0003-000
MUH0341-PRO-SSP	5216-2036-000	1414-11050-000	5814-0003-002	5018-0004-100
MUH0581-PRO-SSP	5216-2036-000	1414-11050-000	5814-0003-000	5018-0003-000
MUH0521-PRO-SSP	5216-2036-000	1414-11050-000	5814-0003-000	5018-0003-000
MUH0541-PRO-SSP	5216-2036-000	1414-11050-000	5814-0003-002	5018-0004-100
MUH078-PRO-SSP	5216-2039-000	1414-11050-000	5814-0003-000	5018-0003-000
MUH072-PRO-SSP	5216-2039-000	1414-11050-000	5814-0003-002	5018-0003-000
MUH074-PRO-SSP	5216-2039-000	1414-11050-000	5814-0003-002	5018-0004-100
MUH108-PRO-SSP	5216-2039-000	1414-11050-000	5814-0003-000	5018-0004-100
MUH102-PRO-SSP	5216-2039-000	1414-11050-000	5814-0003-000	5018-0003-000
MUH104-PRO-SSP	5216-2036-000	1414-11050-000	5814-0003-002	5018-0004-100

MWUH SERIES



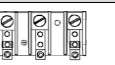



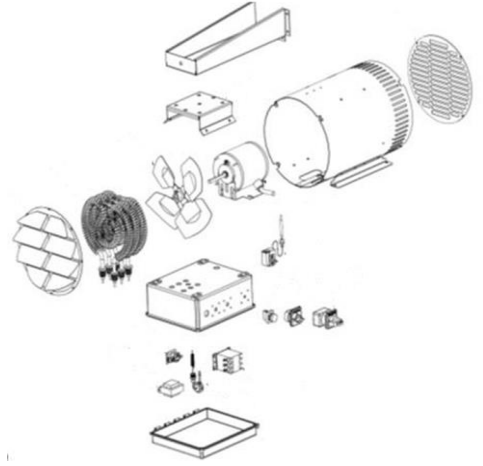

ELEMENT		MOTOR	FAN BLADE	KNOB	THERMOSTAT
					
302006807 MWUH5004 MWUH5004A 302006810 UH724ST UH724STA	302006847 MWUH5008 MWUH5008A	3900-2008-000 MWUH5004 MWUH5004A MWUH5008 MWUH5008A UH724ST UH724STA	1210-2017-000 MWUH5004 MWUH5004A MWUH5008 MWUH5008A UH724ST UH724STA	3301-2014-006 MWUH5004 MWUH5004A MWUH5008 MWUH5008A UH724ST UH724STA	5813-2050-000 MWUH5004 MWUH5004A MWUH5008 MWUH5008A UH724ST UH724STA
POWER BLOCK		RELAY	HI LIMIT	FAN DELAY	LIGHT
					
5823-0004-005 MWUH5004 MWUH5004A MWUH5008 MWUH5008A	5823-0004-000 UH724ST UH724STA	5018-11006-000 UH724ST UH724STA	410027000 MWUH5004 MWUH5004A MWUH5008 MWUH5008A UH724ST UH724STA	410148000 MWUH5004 MWUH5004A MWUH5008 MWUH5008A UH724ST UH724STA	3510-2017-003 MWUH5004A UH724STA
LOUVERS		LOUVER SPRING	MT. BRACKET		
					
3503-2004-109 MWUH5004 MWUH5004A MWUH5008 MWUH5008A UH724ST UH724STA		5208-7005-001 MWUH5004 MWUH5004A MWUH5008 MWUH5008A UH724ST UH724STA	310876001 MWUH5004 MWUH5004A MWUH5008 MWUH5008A UH724ST UH724STA		
					

QPH4A & MUH35 SERIES					
ROCKER SWITCH**	FAN BLADE		ELEMENT***		MOTOR
					
S99814893A000 MUH35 MUH35B MUH35C MUH35D PH4A PH4AB NPH4AB NPH4ABA	1210-2000-000 MUH35 MUH35B MUH35C MUH35D PH4 PH4A	1210-2000-001 PH4AB NPH4AB NPH4ABA	1802-0087-032 MUH35 MUH35B MUH35C MUH35D	1802-0087-038 PH4 PH4A PH4AB NPH4AB NPH4ABA	3900-2002-506 MUH35 MUH35B MUH35C MUH35D PH4 PH4A PH4AB NPH4AB NPH4ABA
FAN DELAY	MANUAL RESET			LIMIT	BUZZER
					
4520-0010-000 MUH35C MUH35D	4520-2017-000 MUH35B MUH35C PH4A	4520-11004-000 PH4AB NPH4AB	4520-11004-002 MUH35D NPH4ABA	4520-0011-000 MUH35 PH4	2714-11001-000 MUH35D
STAND	CONTROL COVER	GRILLE	GUARD	T'STAT KNOB	STAND KNOB**
					
5210-2000-002 MUH35B MUH35C MUH35D PH4A PH4AB NPH4AB NPH4ABA	1402-0336-000 MUH35 MUH35B MUH35C MUH35D PH4 PH4AB NPH4AB NPH4ABA	1402-2154-001 MUH35B MUH35C MUH35D PH4AB NPH4AB NPH4ABA	2504-0011-001 MUH35B MUH35C MUH35D PH4 PH4AB NPH4AB NPH4ABA	3301-2012-001 MUH35B MUH35C MUH35D PH4AB NPH4AB NPH4ABA	3301-2018-000 MUH35 MUH35B MUH35C MUH35D PH4AB NPH4AB NPH4ABA
LIGHT	CORD	THERMOSTAT			
					
3510-2007-000 MUH35B MUH35C MUH35D	1420-2028-000 PH4AB 1420-11012-000 NPH4AB NPH4ABA	5813-2018-000 MUH35 MUH35B MUH35C MUH35D PH4A PH4AB NPH4AB NPH4ABA	5813-0047-000 PH4		
NOTE * INDICATES QUANTITY					

WD SERIES WASHDOWN UNIT HEATER																																		
MOTOR			BLADE			ELEMENT																												
 208-240/480V 2KW-10KW MODELS 277V 3KW-10KW MODELS 120V 2-3KW MODELS 208-240/480V 12.5KW-39KW MODELS			 10KW MODELS 10KW MODELS WITH EPOXY COATING 2-7.5KW MODELS 2-7.5KW MODELS WITH EPOXY COATING 12.5KW MODELS 15-39KW MODELS 12.5KW MODELS WITH EPOXY COATING 15-39KW MODELS WITH EPOXY COATING			 QUANTITY REQ 2KW (2) 3 THRU 15KW (3) 20 THRU 39KW (6)																												
3900-11036-000 3900-11036-001 3900-11036-002 3900-11037-000			1210-11007-000 1210-11007-002 1210-11007-001 1210-11007-003 1210-11008-000 1210-11008-001 1210-11008-002 1210-11008-003			2-3KW 120V 2-3KW 208V 2-3KW 240V 3KW 277V 3KW 480V 5KW 208V 5KW 240V 5KW 277V 5KW 480V 3PH 5KW 480V 1PH 7.5KW 208V 7.5KW 240V 7.5KW 277V 7.5KW 480V		1802-11012-001 1802-11012-002 1802-11012-003 1802-11012-004 1802-11012-005 1802-11012-006 1802-11012-007 1802-11012-008 1802-11012-009 1802-11012-008		10KW 208V 10KW 240V 10KW 277V 10KW 480V 12.5KW 208V 12.5KW 240V 12.5KW 480V 15KW 208V 15KW 240V 20KW 240V 25KW 208V 30KW 240V 15 & 30KW 480V 20KW 480V 39KW 480V		1802-11012-010 1802-11012-011 1802-11012-012 1802-11012-013 1802-11013-001 1802-11013-002 1802-11013-003 1802-11013-004 1802-11013-005 1802-11013-006 1802-11013-007 1802-11013-005 1802-11013-006 1802-11013-008 1802-11013-009																						
LIMIT 2-10KW 12.5-39KW			WALL/CEILING BRK 2-10KW MODELS 12.5-39KW MODELS			HAT BRACKET 2-10KW MODELS 12.5-39KW MODELS																												
																																		
FAN RELAY					CONTACTOR SOA					TRANSFORMER																								
																																		
5018-11005-000					5018-11005-001					5018-0006-000					5018-0006-001																			
QW02112 QW02212 QW02812 QW03112 QW03212 QW03322 QW03432 QW03712 QW03812 QW03832 QW05212 QW05232 QW05412 QW05432 QW05712 QW05812 QW05832 QW07212 QW07232 QW07412 QW07432 QW07712					QW07812 QW07832 QW10212 QW10232 QW10412 QW10432 QW10712 QW10832 QW12212 QW12232 QW12432 QW12812 QW12832 QW15212 QW15232 QW15412 QW15432 QW15812 QW15832 QW20232 QW20412 QW20432					QW02112 QW02212 QW02812 QW03112 QW03212 QW03322 QW03432 QW03712 QW03812 QW03832 QW05212 QW05232 QW05412 QW05432 QW05712 QW05812 QW05832 QW07212 QW07232 QW07412 QW07432 QW07712					QW07812 QW07832 QW10212 QW10232 QW10412 QW10432 QW10712 QW10832 QW12212 QW12232 QW12432 QW12812 QW12832 QW15212 QW15232 QW15412 QW15432 QW15812 QW15832 QW20232 QW20412 QW20432					QW02532 QW025432 QW025832 QW03032 QW030432 QW030832 QW039432					QW005431 QW007831 QW030431					QW005431 QW007831 QW030431				
QW02112 QW02212 QW02812 QW03112 QW03212 QW03322 QW03432 QW03712 QW03812 QW03832 QW05212 QW05232 QW05412 QW05432 QW05712 QW05812 QW05832 QW07212 QW07232 QW07412 QW07432 QW07712					QW07812 QW07832 QW10212 QW10232 QW10412 QW10432 QW10712 QW10832 QW12212 QW12232 QW12432 QW12812 QW12832 QW15212 QW15232 QW15412 QW15432 QW15812 QW15832 QW20232 QW20412 QW20432					QW02532 QW025432 QW025832 QW03032 QW030432 QW030832 QW039432					QW005431 QW007831 QW030431					QW005431 QW007831 QW030431														
QW02112 QW02212 QW02812 QW03112 QW03212 QW03322 QW03432 QW03712 QW03812 QW03832 QW05212 QW05232 QW05412 QW05432 QW05712 QW05812 QW05832 QW07212 QW07232 QW07412 QW07432 QW07712					QW07812 QW07832 QW10212 QW10232 QW10412 QW10432 QW10712 QW10832 QW12212 QW12232 QW12432 QW12812 QW12832 QW15212 QW15232 QW15412 QW15432 QW15812 QW15832 QW20232 QW20412 QW20432					QW02532 QW025432 QW025832 QW03032 QW030432 QW030832 QW039432					QW005431 QW007831 QW030431					QW005431 QW007831 QW030431														
QW02112 QW02212 QW02812 QW03112 QW03212 QW03322 QW03432 QW03712 QW03812 QW03832 QW05212 QW05232 QW05412 QW05432 QW05712 QW05812 QW05832 QW07212 QW07232 QW07412 QW07432 QW07712					QW07812 QW07832 QW10212 QW10232 QW10412 QW10432 QW10712 QW10832 QW12212 QW12232 QW12432 QW12812 QW12832 QW15212 QW15232 QW15412 QW15432 QW15812 QW15832 QW20232 QW20412 QW20432					QW02532 QW025432 QW025832 QW03032 QW030432 QW030832 QW039432					QW005431 QW007831 QW030431					QW005431 QW007831 QW030431														
QW02112 QW02212 QW02812 QW03112 QW03212 QW03322 QW03432 QW03712 QW03812 QW03832 QW05212 QW05232 QW05412 QW05432 QW05712 QW05812 QW05832 QW07212 QW07232 QW07412 QW07432 QW07712					QW07812 QW07832 QW10212 QW10232 QW10412 QW10432 QW10712 QW10832 QW12212 QW12232 QW12432 QW12812 QW12832 QW15212 QW15232 QW15412 QW15432 QW15812 QW15832 QW20232 QW20412 QW20432					QW02532 QW025432 QW025832 QW03032 QW030432 QW030832 QW039432					QW005431 QW007831 QW030431					QW005431 QW007831 QW030431														
GRILLE INLET 2-10KW MODELS 12.5-39KW MODELS					GRILLE INLET 2-10KW MODELS 12.5-39KW MODELS					STRAIGHT FITTING					SILICONE SEAL																			
																																		
2504-11018-000 2504-11020-000					2504-11019-001 2504-11021-001					1213-2009-000 ALL MODELS					5250-2001-000 ALL MODELS																			
CAPACITOR					POWER BLOCK					TERMINAL BLOCK																								
																																		
1432-0002-001					1432-0002-003					1432-0002-004					5823-0004-002					480034002														
QW02112 QW02212 QW02812 QW03112 QW03212 QW03322 QW03432 QW03712 QW03812 QW03832 QW05212 QW05232 QW05412 QW05432					QW02112 QW02212 QW02812 QW03112 QW03212 QW03322 QW03432 QW03712 QW03812 QW03832 QW05212 QW05232 QW05412 QW05432					QW02112 QW02212 QW02812 QW03112 QW03212 QW03322 QW03432 QW03712 QW03812 QW03832 QW05212 QW05232 QW05412 QW05432					QW02112 QW02212 QW02812 QW03112 QW03212 QW03322 QW03432 QW03712 QW03812 QW03832 QW05212 QW05232 QW05412 QW05432					QW02112 QW02212 QW02812 QW03112 QW03212 QW03322 QW03432 QW03712 QW03812 QW03832 QW05212 QW05232 QW05412 QW05432					QW02112 QW02212 QW02812 QW03112 QW03212 QW03322 QW03432 QW03712 QW03812 QW03832 QW05212 QW05232 QW05412 QW05432									
PART					GASKET					KNOB																								
THERMOSTAT					PILOT LIGHT					MODE SWITCH					DISCONNECT SWITCH					MANUAL RESET														
SM/MD UNITS LRG UNITS					120V CONTROL 24V CONTROL					SM/MD UNITS LRG UNITS					40AMP 60AMP 100AMP 125AMP					SM/MD UNITS LRG UNITS														
5813-11010-000					3510-11009-001 3510-11009-000					5216-11016-000 5216-11016-000					5216-11017-000 5216-11017-001 5216-11017-002 5216-11017-003					4520-11017-000 4520-11017-001														
5206-11009-000 5206-11010-000					N/A					5206-11009-000					5206-11009-000					N/A														
3301-11010-000					N/A					PART OF SW. ASSM					PART OF SW. ASSM					N/A														
N/A					N/A					N/A					N/A					N/A														
N/A					N/A					N/A					N/A					N/A														

CATALOG NUMBER	DESCRIPTION
T	Thermostat
L	Pilot Light
S	Mode/Selector Switch
D	Disconnect Switch
E	Monel Element*
M	Manual Reset
P	Epoxy Coating



KCJ														
ELEMENT				LINEAR LIMIT			TR. RELAY							
														
1802-11021-003 J400B	1802-2044-011 J750B	1802-2044-014 J1007B	1802-2044-228 J1503B	4520-2018-000 J400B	4520-2018-003 J1000B	4520-2018-005 J1500B	5018-11003-003 J503B	410043007 J1006B						
1802-11021-001 J404B	1802-2044-210 J753B	1802-2044-016 J1008B	1802-2044-027 J1504B	J404B	J1003B	J1503B	J753B	J1256B						
1802-11021-000 J407B	1802-2044-009 J754B	1802-2044-023 J1250B	1802-2044-229 J1506B	J407B	J1004B	J1504B	J1003B	J1506B						
1802-11021-002 J408B	1802-2044-008 J757B	1802-2044-222 J1253B	1802-2044-026 J1507B	J408B	J1006B	J1506B	J1253B	J2006B						
1802-2044-043 J500B	1802-2044-010 J758B	1802-2044-021 J1254B	1802-2044-028 J1508B	4520-2018-001 J500B	J1007B	J1507B	J1503B							
1802-2044-202 J503B	1802-2044-017 J1000B	1802-2044-223 J1256B	1802-2044-234 J2003B	J503B	4520-2018-004 J1250B	4520-2018-006 J2003B	J2003B							
1802-2044-041 J504B	1802-2044-216 J1003B	1802-2044-020 J1257B	1802-2044-033 J2004B	J507B	J1253B	J2004B	J2004B							
1802-2044-040 J507B	1802-2044-015 J1004B	1802-2044-022 J1258B	1802-2044-235 J2006B	J508B	J1254B	J2006B	J2006B							
1802-2044-042 J508B	1802-2044-217 J1006B	1802-2044-029 J1500B	1802-2044-032 J2007B	4520-2018-002 J750B	J1256B	J2007B	J2007B							
			1802-2044-034 J2008B	J753B	J1257B	J2008B	J2008B							
				J754B	J1258B									
				J757B										
				J758B										
SWITCH		FRONT COVER			CONTROL COVER	THERMOSTAT								
														
5216-11007-000 J400B J404B J407B J408B J500B J504B J507B J508B J750B J754B J757B J758B J1000B J1004B		5216-2053-000 J503B J753B J1003B J1250B J1257B J1258B J1500B J1503B J1504B J1506B J2003B J2006B			1402-2192-006 J400B J404B J407B J408B 1402-2192-001 J500B J503B J504B J507B J508B 1402-2192-002 J750B J753B J754B J757B J758B		1402-2192-003 J1000B J1003B J1004B J1006B J1007B J1008B 1402-2192-004 J1250B J1253B J1254B J1256B J1257B J1258B		1402-2192-005 J1500B J1503B J1504B J1506B J1507B J1508B 1402-2192-007 J2003B J2004B J2006B J2007B J2008B		1402-11020-000 ALL MODELS		5813-11014-000 ALL MODELS	
														

SHA & DBA SERIES



DISCRIPTION	PART NUMBERS					
	120V	208V	240V	277V	347V	600V
*ELEMENT (100 WATTS/FT)						
28" HEATER	1802-2001-047	1802-2001-048	1802-2001-049	NA	NA	NA
3'	1802-2001-053	1802-2001-054	1802-2001-055	1802-2001-056	NA	NA
4'	1802-2001-059	1802-2001-060	1802-2001-061	1802-2001-062	1802-2001-232	NA
5'	1802-2001-065	1802-2001-066	1802-2001-067	1802-2001-068	1802-2001-242	NA
6'	1802-2001-071	1802-2001-072	1802-2001-073	1802-2001-074	1802-2001-252	1802-2001-253
8'	NA	1802-2001-077	1802-2001-078	1802-2001-079	1802-2001-262	1802-2001-263
10'	NA	1802-2001-081	1802-2001-082	1802-2001-083	1802-2001-272	1802-2001-273
*ELEMENT (125 WATTS/FT)						
28" HEATER	1802-2001-085	1802-2001-086	1802-2001-048	1802-2001-049	NA	NA
3'	1802-2001-087	1802-2001-088	1802-2001-054	1802-2001-055	1802-2001-220	NA
4'	1802-2001-089	1802-2001-090	1802-2001-060	1802-2001-061	1802-2001-230	NA
5'	1802-2001-091	1802-2001-092	1802-2001-066	1802-2001-067	1802-2001-240	1802-2001-241
6'	1802-2001-093	1802-2001-094	1802-2001-072	1802-2001-073	1802-2001-250	1802-2001-251
8'	NA	1802-2001-095	1802-2001-077	1802-2001-078	1802-2001-260	1802-2001-261
10'	NA	1802-2001-096	1802-2001-081	1802-2001-082	1802-2001-270	1802-2001-271
*ELEMENT (150 WATTS/FT)						
28" HEATER	1802-2001-051	1802-2001-001	1802-2001-000	1802-2001-052	NA	NA
3'	1802-2001-057	1802-2001-007	1802-2001-006	1802-2001-058	1802-2001-218	NA
4'	1802-2001-063	1802-2001-013	1802-2001-012	1802-2001-064	1802-2001-228	NA
5'	1802-2001-069	1802-2001-019	1802-2001-018	1802-2001-070	1802-2001-238	1802-2001-239
6'	1802-2001-075	1802-2001-025	1802-2001-024	1802-2001-076	1802-2001-248	1802-2001-249
8'	NA	1802-2001-031	1802-2001-030	1802-2001-080	1802-2001-258	1802-2001-259
10'	NA	1802-2001-035	1802-2001-034	1802-2001-084	1802-2001-268	1802-2001-269
*ELEMENT (188 WATTS/FT)						
28" HEATER	1802-2001-005	1802-2001-002	1802-2001-001	1802-2001-000	NA	NA
3'	1802-2001-011	1802-2001-008	1802-2001-007	1802-2001-006	1802-2001-216	NA
4'	1802-2001-017	1802-2001-014	1802-2001-013	1802-2001-012	1802-2001-226	1802-2001-227
5'	1802-2001-023	1802-2001-020	1802-2001-019	1802-2001-018	1802-2001-236	1802-2001-237
6'	1802-2001-029	1802-2001-026	1802-2001-025	1802-2001-024	1802-2001-246	1802-2001-247
8'	NA	1802-2001-032	1802-2001-031	1802-2001-030	1802-2001-256	1802-2001-257
10'	NA	1802-2001-036	1802-2001-035	1802-2001-034	1802-2001-266	1802-2001-267
*ELEMENT (250 WATTS/FT)						
28" HEATER	1802-2001-004	1802-2001-003	1802-2001-002	1802-2001-001	1802-2001-202	NA
3'	1802-2001-010	1802-2001-009	1802-2001-008	1802-2001-007	1802-2001-214	NA
4'	1802-2001-016	1802-2001-015	1802-2001-014	1802-2001-013	1802-2001-224	1802-2001-225
5'	1802-2001-022	1802-2001-021	1802-2001-020	1802-2001-019	1802-2001-234	1802-2001-235
6'	1802-2001-028	1802-2001-027	1802-2001-026	1802-2001-025	1802-2001-244	1802-2001-245
8'	NA	1802-2001-033	1802-2001-032	1802-2001-031	1802-2001-254	1802-2001-255
10'	NA	1802-2001-037	1802-2001-036	1802-2001-035	1802-2001-264	1802-2001-265
<p>* 1, 2 OR 3 ELEMENTS MAY BE REQUIRED. VOLTAGE AND WATTAGE ARE STAMPED ON END OF ELEMENTS. DIVIDE THE WATTAGE BY THE HEATER LENGTH (FEET) TO DETERMINE WATTS/FOOT OF ELEMENT. THEN USE THIS DATA TO DETERMINE PART NUMBER OF HEATING ELEMENT.</p>						

DISCRIPTION	PART NUMBERS					
	120V	208V	240V	277V	347V	600V
LINEAR LIMIT						
28" HEATER	4520-0007-007	4520-0007-007	4520-0007-007	4520-0007-007	4520-0007-007	4520-0007-007
3'	4520-0007-008	4520-0007-008	4520-0007-008	4520-0007-008	4520-0007-008	4520-0007-008
4'	4520-0007-009	4520-0007-009	4520-0007-009	4520-0007-009	4520-0007-009	4520-0007-009
5'	4520-0007-010	4520-0007-010	4520-0007-010	4520-0007-010	4520-0007-010	4520-0007-010
6'	4520-0007-011	4520-0007-011	4520-0007-011	4520-0007-011	4520-0007-011	4520-0007-011
8'	NA	4520-0007-012	4520-0007-012	4520-0007-012	4520-0007-012	4520-0007-012
10'	NA	4520-0007-013	4520-0007-013	4520-0007-013	4520-0007-013	4520-0007-013
DISCONNECT SW.	THERMOSTAT	TRANSFORMER		POWER RELAY		
410170001	2-STAGE 5813-0023-000 SINGLE POLE 5813-11014-000	120V 5018-11003-000 208/240V 5018-11003-001	277V 5018-11003-002 347V 5018-11003-003	24V 410171001 120V 410171002	208/240V/277V 410171003	

SLQDB SERIES

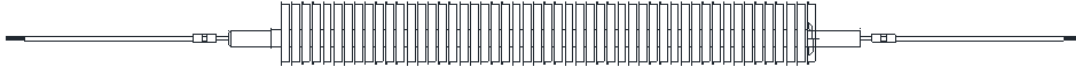

DISCRPTION	PART NUMBERS					
	120V	208V	240V	277V	347V	600V
*ELEMENT (100 WATTS/FT)						
28" HEATER	1802-2001-047	1802-2001-048	1802-2001-049	NA	NA	NA
3'	1802-2001-053	1802-2001-054	1802-2001-055	1802-2001-056	NA	NA
4'	1802-2001-059	1802-2001-060	1802-2001-061	1802-2001-062	1802-2001-232	NA
5'	1802-2001-065	1802-2001-066	1802-2001-067	1802-2001-068	1802-2001-242	NA
6'	1802-2001-071	1802-2001-072	1802-2001-073	1802-2001-074	1802-2001-252	1802-2001-253
8'	NA	1802-2001-077	1802-2001-078	1802-2001-079	1802-2001-262	1802-2001-263
10'	NA	1802-2001-081	1802-2001-082	1802-2001-083	1802-2001-272	1802-2001-273
*ELEMENT (125 WATTS/FT)						
28" HEATER	1802-2001-085	1802-2001-086	1802-2001-048	1802-2001-049	NA	NA
3'	1802-2001-087	1802-2001-088	1802-2001-054	1802-2001-055	1802-2001-220	NA
4'	1802-2001-089	1802-2001-090	1802-2001-060	1802-2001-061	1802-2001-230	NA
5'	1802-2001-091	1802-2001-092	1802-2001-066	1802-2001-067	1802-2001-240	1802-2001-241
6'	1802-2001-093	1802-2001-094	1802-2001-072	1802-2001-073	1802-2001-250	1802-2001-251
8'	NA	1802-2001-095	1802-2001-077	1802-2001-078	1802-2001-260	1802-2001-261
10'	NA	1802-2001-096	1802-2001-081	1802-2001-082	1802-2001-270	1802-2001-271
*ELEMENT (150 WATTS/FT)						
28" HEATER	1802-2001-051	1802-2001-001	1802-2001-000	1802-2001-052	NA	NA
3'	1802-2001-057	1802-2001-007	1802-2001-006	1802-2001-058	1802-2001-218	NA
4'	1802-2001-063	1802-2001-013	1802-2001-012	1802-2001-064	1802-2001-228	NA
5'	1802-2001-069	1802-2001-019	1802-2001-018	1802-2001-070	1802-2001-238	1802-2001-239
6'	1802-2001-075	1802-2001-025	1802-2001-024	1802-2001-076	1802-2001-248	1802-2001-249
8'	NA	1802-2001-031	1802-2001-030	1802-2001-080	1802-2001-258	1802-2001-259
10'	NA	1802-2001-035	1802-2001-034	1802-2001-084	1802-2001-268	1802-2001-269
*ELEMENT (188 WATTS/FT)						
24" HEATER	1802-2001-038	1802-2001-039	1802-2001-040	1802-2001-041	1802-2001-200	NA
28"	1802-2001-005	1802-2001-002	1802-2001-001	1802-2001-000	NA	NA
3'	1802-2001-011	1802-2001-008	1802-2001-007	1802-2001-006	1802-2001-216	NA
4'	1802-2001-017	1802-2001-014	1802-2001-013	1802-2001-012	1802-2001-226	1802-2001-227
5'	1802-2001-023	1802-2001-020	1802-2001-019	1802-2001-018	1802-2001-236	1802-2001-237
6'	1802-2001-029	1802-2001-026	1802-2001-025	1802-2001-024	1802-2001-246	1802-2001-247
8'	NA	1802-2001-032	1802-2001-031	1802-2001-030	1802-2001-256	1802-2001-257
10'	NA	1802-2001-036	1802-2001-035	1802-2001-034	1802-2001-266	1802-2001-267
LINEAR LIMIT		DISCONNECT SW.	THERMOSTAT			
28" HEATER	4520-0007-007	410170001	2-STAGE	SINGLE POLE		
3'	4520-0007-008		5813-0023-000	410129002		
4'	4520-0007-009					
5'	4520-0007-010					
6'	4520-0007-011					
8'	4520-0007-012					
10'	4520-0007-013					

DBSL SERIES

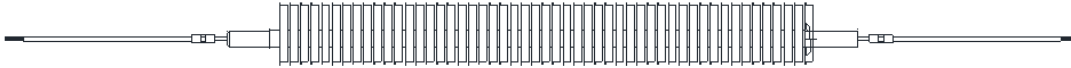

DISCRIPTION	PART NUMBERS					
	120V	208V	240V	277V	347V	600V
*ELEMENT (100 WATTS/FT)						
28" HEATER	1802-2001-047	1802-2001-048	1802-2001-049	NA	NA	NA
3'	1802-2001-053	1802-2001-054	1802-2001-055	1802-2001-056	NA	NA
4'	1802-2001-059	1802-2001-060	1802-2001-061	1802-2001-062	1802-2001-232	NA
5'	1802-2001-065	1802-2001-066	1802-2001-067	1802-2001-068	1802-2001-242	NA
6'	1802-2001-071	1802-2001-072	1802-2001-073	1802-2001-074	1802-2001-252	1802-2001-253
8'	NA	1802-2001-077	1802-2001-078	1802-2001-079	1802-2001-262	1802-2001-263
10'	NA	1802-2001-081	1802-2001-082	1802-2001-083	1802-2001-272	1802-2001-273
*ELEMENT (125 WATTS/FT)						
28" HEATER	1802-2001-085	1802-2001-086	1802-2001-048	1802-2001-049	NA	NA
3'	1802-2001-087	1802-2001-088	1802-2001-054	1802-2001-055	1802-2001-220	NA
4'	1802-2001-089	1802-2001-090	1802-2001-060	1802-2001-061	1802-2001-230	NA
5'	1802-2001-091	1802-2001-092	1802-2001-066	1802-2001-067	1802-2001-240	1802-2001-241
6'	1802-2001-093	1802-2001-094	1802-2001-072	1802-2001-073	1802-2001-250	1802-2001-251
8'	NA	1802-2001-095	1802-2001-077	1802-2001-078	1802-2001-260	1802-2001-261
10'	NA	1802-2001-096	1802-2001-081	1802-2001-082	1802-2001-270	1802-2001-271
*ELEMENT (150 WATTS/FT)						
28" HEATER	1802-2001-051	1802-2001-001	1802-2001-000	1802-2001-052	NA	NA
3'	1802-2001-057	1802-2001-007	1802-2001-006	1802-2001-058	1802-2001-218	NA
4'	1802-2001-063	1802-2001-013	1802-2001-012	1802-2001-064	1802-2001-228	NA
5'	1802-2001-069	1802-2001-019	1802-2001-018	1802-2001-070	1802-2001-238	1802-2001-239
6'	1802-2001-075	1802-2001-025	1802-2001-024	1802-2001-076	1802-2001-248	1802-2001-249
8'	NA	1802-2001-031	1802-2001-030	1802-2001-080	1802-2001-258	1802-2001-259
10'	NA	1802-2001-035	1802-2001-034	1802-2001-084	1802-2001-268	1802-2001-269
*ELEMENT (188 WATTS/FT)						
24" HEATER	1802-2001-038	1802-2001-039	1802-2001-040	1802-2001-041	1802-2001-200	NA
28"	1802-2001-005	1802-2001-002	1802-2001-001	1802-2001-000	NA	NA
3'	1802-2001-011	1802-2001-008	1802-2001-007	1802-2001-006	1802-2001-216	NA
4'	1802-2001-017	1802-2001-014	1802-2001-013	1802-2001-012	1802-2001-226	1802-2001-227
5'	1802-2001-023	1802-2001-020	1802-2001-019	1802-2001-018	1802-2001-236	1802-2001-237
6'	1802-2001-029	1802-2001-026	1802-2001-025	1802-2001-024	1802-2001-246	1802-2001-247
8'	NA	1802-2001-032	1802-2001-031	1802-2001-030	1802-2001-256	1802-2001-257
10'	NA	1802-2001-036	1802-2001-035	1802-2001-034	1802-2001-266	1802-2001-267
*ELEMENT (250 WATTS/FT)						
28" HEATER	1802-2001-004	1802-2001-003	1802-2001-002	1802-2001-001	1802-2001-202	NA
3'	1802-2001-010	1802-2001-009	1802-2001-008	1802-2001-007	1802-2001-214	NA
4'	1802-2001-016	1802-2001-015	1802-2001-014	1802-2001-013	1802-2001-224	1802-2001-225
5'	1802-2001-022	1802-2001-021	1802-2001-020	1802-2001-019	1802-2001-234	1802-2001-235
6'	1802-2001-028	1802-2001-027	1802-2001-026	1802-2001-025	1802-2001-244	1802-2001-245
8'	NA	1802-2001-033	1802-2001-032	1802-2001-031	1802-2001-254	1802-2001-255
10'	NA	1802-2001-037	1802-2001-036	1802-2001-035	1802-2001-264	1802-2001-265
LINEAR LIMIT		DISCONNECT SW.	THERMOSTAT			
28" HEATER	4520-0007-007	410170001	2-STAGE			
3'	4520-0007-008		5813-0023-000			
4'	4520-0007-009		SINGLE POLE			
5'	4520-0007-010		5813-11014-000			
6'	4520-0007-011					
8'	4520-0007-012					
10'	4520-0007-013					
TRANSFORMER		POWER RELAY				
120V	277V	24V	208/240V/277V			
5018-11003-000	5018-11003-002	410171001	410171003			
208/240V	347V	120V				
5018-11003-001	5018-11003-003	410171002				





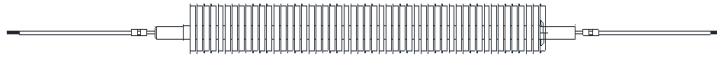

ST SERIES



DISCRIPTION	PART NUMBERS					
	120V	208V	240V	277V	347V	600V
*ELEMENT (125 WATTS/FT)						
28" HEATER	1802-2001-085	1802-2001-086	1802-2001-048	1802-2001-049	NA	NA
3'	1802-2001-087	1802-2001-088	1802-2001-054	1802-2001-055	1802-2001-220	NA
4'	1802-2001-089	1802-2001-090	1802-2001-060	1802-2001-061	1802-2001-230	NA
5'	1802-2001-091	1802-2001-092	1802-2001-066	1802-2001-067	1802-2001-240	1802-2001-241
6'	1802-2001-093	1802-2001-094	1802-2001-072	1802-2001-073	1802-2001-250	1802-2001-251
8'	NA	1802-2001-095	1802-2001-077	1802-2001-078	1802-2001-260	1802-2001-261
10'	NA	1802-2001-096	1802-2001-081	1802-2001-082	1802-2001-270	1802-2001-271
*ELEMENT (188 WATTS/FT)						
28" HEATER	1802-2001-005	1802-2001-002	1802-2001-001	1802-2001-000	NA	NA
3'	1802-2001-011	1802-2001-008	1802-2001-007	1802-2001-006	1802-2001-216	NA
4'	1802-2001-017	1802-2001-014	1802-2001-013	1802-2001-012	1802-2001-226	1802-2001-227
5'	1802-2001-023	1802-2001-020	1802-2001-019	1802-2001-018	1802-2001-236	1802-2001-237
6'	1802-2001-029	1802-2001-026	1802-2001-025	1802-2001-024	1802-2001-246	1802-2001-247
8'	NA	1802-2001-032	1802-2001-031	1802-2001-030	1802-2001-256	1802-2001-257
10'	NA	1802-2001-036	1802-2001-035	1802-2001-034	1802-2001-266	1802-2001-267
*ELEMENT (250 WATTS/FT)						
28" HEATER	1802-2001-004	1802-2001-003	1802-2001-002	1802-2001-001	1802-2001-202	NA
3'	1802-2001-010	1802-2001-009	1802-2001-008	1802-2001-007	1802-2001-214	NA
4'	1802-2001-016	1802-2001-015	1802-2001-014	1802-2001-013	1802-2001-224	1802-2001-225
5'	1802-2001-022	1802-2001-021	1802-2001-020	1802-2001-019	1802-2001-234	1802-2001-235
6'	1802-2001-028	1802-2001-027	1802-2001-026	1802-2001-025	1802-2001-244	1802-2001-245
8'	NA	1802-2001-033	1802-2001-032	1802-2001-031	1802-2001-254	1802-2001-255
10'	NA	1802-2001-037	1802-2001-036	1802-2001-035	1802-2001-264	1802-2001-265

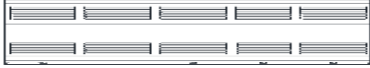

DISCRIPTION	PART NUMBERS					
	120V	208V	240V	277V	347V	600V
LINEAR LIMIT						
28" HEATER	4520-2018-001	4520-2018-001	4520-2018-001	4520-2018-001	4520-2018-001	4520-2018-001
3'	4520-2018-002	4520-2018-002	4520-2018-002	4520-2018-002	4520-2018-002	4520-2018-002
4'	4520-2018-003	4520-2018-003	4520-2018-003	4520-2018-003	4520-2018-003	4520-2018-003
5'	4520-2018-004	4520-2018-004	4520-2018-004	4520-2018-004	4520-2018-004	4520-2018-004
6'	4520-2018-005	4520-2018-005	4520-2018-005	4520-2018-005	4520-2018-005	4520-2018-005
8'	NA	4520-2018-006	4520-2018-006	4520-2018-006	4520-2018-006	4520-2018-006
10'	NA	4520-2018-007	4520-2018-007	4520-2018-007	4520-2018-007	4520-2018-007
DISCONNECT SW.	THERMOSTAT	TRANSFORMER RELAY		J-BOX COVER	FRONT COVER	
						
DS	2-STAGE 5813-0023-000 SINGLE POLE 5813-11014-000	120V 5018-11003-000 208/240V 5018-11003-001	277V 5018-11003-002 347V 5018-11003-003	ALL MODELS 1402-2250-000	1402-2251-000 1402-2251-001 1402-2251-002 1402-2251-003 1402-2251-004 1402-2251-005 1402-2251-006	28" 3' 4' 5' 6' 8' 10'

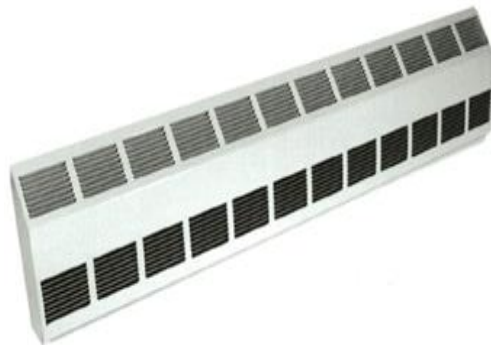
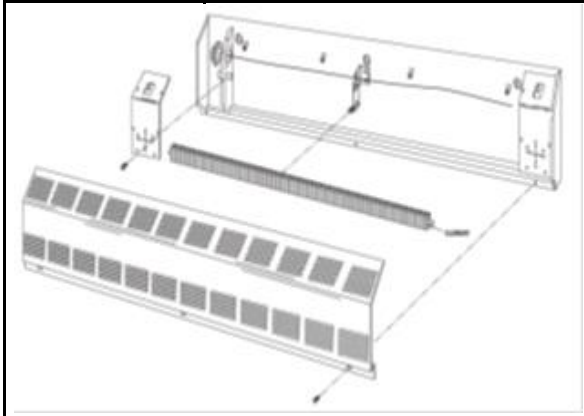

CSH, DSH, CPH & DPH SERIES







DISCRPTION	PART NUMBERS					
	120V	208V	240V	277V	347V	600V
*ELEMENT (125 WATTS/FT)						
28" HEATER	1802-2001-085	1802-2001-086	1802-2001-048	1802-2001-049	NA	NA
3'	1802-2001-087	1802-2001-088	1802-2001-054	1802-2001-055	1802-2001-220	NA
4'	1802-2001-089	1802-2001-090	1802-2001-060	1802-2001-061	1802-2001-230	NA
5'	1802-2001-091	1802-2001-092	1802-2001-066	1802-2001-067	1802-2001-240	1802-2001-241
6'	1802-2001-093	1802-2001-094	1802-2001-072	1802-2001-073	1802-2001-250	1802-2001-251
8'	NA	1802-2001-095	1802-2001-077	1802-2001-078	1802-2001-260	1802-2001-261
10'	NA	1802-2001-096	1802-2001-081	1802-2001-082	1802-2001-270	1802-2001-271
*ELEMENT (188 WATTS/FT)						
28" HEATER	1802-2001-005	1802-2001-002	1802-2001-001	1802-2001-000	NA	NA
3'	1802-2001-011	1802-2001-008	1802-2001-007	1802-2001-006	1802-2001-216	NA
4'	1802-2001-017	1802-2001-014	1802-2001-013	1802-2001-012	1802-2001-226	1802-2001-227
5'	1802-2001-023	1802-2001-020	1802-2001-019	1802-2001-018	1802-2001-236	1802-2001-237
6'	1802-2001-029	1802-2001-026	1802-2001-025	1802-2001-024	1802-2001-246	1802-2001-247
8'	NA	1802-2001-032	1802-2001-031	1802-2001-030	1802-2001-256	1802-2001-257
10'	NA	1802-2001-036	1802-2001-035	1802-2001-034	1802-2001-266	1802-2001-267
*ELEMENT (250 WATTS/FT)						
28" HEATER	1802-2001-004	1802-2001-003	1802-2001-002	1802-2001-001	1802-2001-202	NA
3'	1802-2001-010	1802-2001-009	1802-2001-008	1802-2001-007	1802-2001-214	NA
4'	1802-2001-016	1802-2001-015	1802-2001-014	1802-2001-013	1802-2001-224	1802-2001-225
5'	1802-2001-022	1802-2001-021	1802-2001-020	1802-2001-019	1802-2001-234	1802-2001-235
6'	1802-2001-028	1802-2001-027	1802-2001-026	1802-2001-025	1802-2001-244	1802-2001-245
8'	NA	1802-2001-033	1802-2001-032	1802-2001-031	1802-2001-254	1802-2001-255
10'	NA	1802-2001-037	1802-2001-036	1802-2001-035	1802-2001-264	1802-2001-265

* 1, 2 OR 3 ELEMENTS MAY BE REQUIRED. VOLTAGE AND WATTAGE ARE STAMPED ON END OF ELEMENTS. DIVIDE THE WATTAGE BY THE HEATER LENGTH (FEET) TO DETERMINE WATTS/FOOT OF ELEMENT. THEN USE THIS DATA TO DETERMINE PART NUMBER OF HEATING ELEMENT.



DISCRPTION	PART NUMBERS					
	120V	208V	240V	277V	347V	600V
LINEAR LIMIT						
28" HEATER	4520-0007-007	4520-0007-007	4520-0007-007	4520-0007-007	4520-0007-007	4520-0007-007
3'	4520-0007-008	4520-0007-008	4520-0007-008	4520-0007-008	4520-0007-008	4520-0007-008
4'	4520-0007-009	4520-0007-009	4520-0007-009	4520-0007-009	4520-0007-009	4520-0007-009
5'	4520-0007-010	4520-0007-010	4520-0007-010	4520-0007-010	4520-0007-010	4520-0007-010
6'	4520-0007-011	4520-0007-011	4520-0007-011	4520-0007-011	4520-0007-011	4520-0007-011
8'	NA	4520-0007-012	4520-0007-012	4520-0007-012	4520-0007-012	4520-0007-012
10'	NA	4520-0007-013	4520-0007-013	4520-0007-013	4520-0007-013	4520-0007-013

DISCONNECT SW.	THERMOSTAT	TRANSFORMER RELAY		24V TRANSFORMER
				
410170001	2-STAGE 5813-0023-000 SINGLE POLE 5813-11014-000	120V 5018-11003-000 208/240V 5018-11003-001	277V 5018-11003-002 347V 5018-11003-003	208/240V PRIMARY 490026001 277V PRIMARY 490026002

CIRCUIT BREAKER	POWER RELAY	
		
2-POLE, 30A 1226-7009-013 2-POLE, 60A 1226-7009-010 3-POLE, 30A 1226-7009-005 3-POLE, 60A 1226-7009-002	24V 410171001 120V 410171002 208/240V 410171003	277V 410171003



THX FLOOR DROP-IN CONVECTOR							
ELEMENTS							
2 FOOT 188W/FT		2 FOOT 250W/FT		3 FOOT 188W/FT		3 FOOT 250W/FT	
208V	1802-2001-039	208V	1802-2001-198	208V	1802-2001-008	208V	1802-2001-009
240V	1802-2001-040	240V	1802-2001-099	240V	1802-2001-007	240V	1802-2001-008
277V	1802-2001-041	277V	1802-2001-200	277V	1802-2001-006	277V	1802-2001-007
4 FOOT 188W/FT		4 FOOT 250W/FT		5 FOOT 188W/FT		5 FOOT 250W/FT	
208V	1802-2001-014	208V	1802-2001-015	208V	1802-2001-020	208V	1802-2001-021
240V	1802-2001-013	240V	1802-2001-014	240V	1802-2001-019	240V	1802-2001-020
277V	1802-2001-012	277V	1802-2001-013	277V	1802-2001-018	277V	1802-2001-019

GRILLE							
2 FOOT FLUSH		2 FOOT SURFACE		3 FOOT FLUSH		3 FOOT SURFACE	
ALUMINUM	2501-11033-001	ALUMINUM	2501-11033-005	ALUMINUM	2501-11033-002	ALUMINUM	2501-11033-006
BLACK	2501-11033-101	BLACK	2501-11033-105	BLACK	2501-11033-102	BLACK	2501-11033-106
WHITE	2501-11033-201	WHITE	2501-11033-205	WHITE	2501-11033-202	WHITE	2501-11033-206
4 FOOT FLUSH		4 FOOT SURFACE		5 FOOT FLUSH		5 FOOT SURFACE	
ALUMINUM	2501-11033-003	ALUMINUM	2501-11033-007	ALUMINUM	2501-11033-004	ALUMINUM	2501-11033-008
BLACK	2501-11033-103	BLACK	2501-11033-107	BLACK	2501-11033-104	BLACK	2501-11033-108
WHITE	2501-11033-203	WHITE	2501-11033-207	WHITE	2501-11033-204	WHITE	2501-11033-208

TRANSFORMER	
277V	208/240V
5018-11003-002	5018-11003-001

TIME DELAY RELAY		
24V CONTROL	120V CONTROL	208-277V CONTROL
410171001	410171002	410171003

LINEAR LIMIT			
2 FOOT	3 FOOT	4 FOOT	5 FOOT
4520-0007-007	4520-0007-008	4520-0007-009	4520-0007-010
MANUAL RESET LIMIT			
2 FOOT	3 FOOT	4 FOOT	5 FOOT
4520-2017-000	4520-2017-000	4520-2017-001	4520-2017-001

POWER ON/OFF SW
ALL MODELS 410170001
J-BOX COVER
ALL MODELS 1215-11125-000

BRM SERIES

ELEMENT

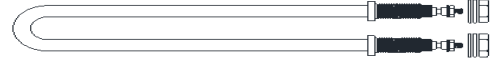

1802-7076-002 M2081B M6083B	1802-7076-007 M4581B M13583B	1802-2110-007 M6043A 1802-2110-009 M4581A M13583A	HE45208 M4581 M13583 HE45240 M4521 M13523 HE45480 M4541 M13543 HE45600 M13563	HE20208 M6083 HE20240 M6023 HE20480 M6043 HE20600 M6063
1802-7076-003 M2021B M6023B	1802-7076-008 M4521B M13523B	1802-2110-011 M4521A M13523A		
1802-7076-004 M6071B	1802-7076-009 M13571B	1802-2110-015 M4541A M13543A		
1802-7076-005 M2041B M6043B	1802-7076-010 M4541B M13543B	1802-2110-016 M13563A		
1802-7076-006 M2061B M6063B	1802-7076-011 M4561B M13563B			

NOTES

6KW AND 13.5KW UNITS TAKE THREE ELEMENTS



2.0 KW

6.0 KW Fixed







4.5 KW Fixed

13.5 KW Fixed w/Grille







REFLECTOR

891755004 M6023B M6043B	891755002 M13523B M13543B M4521B M4541B
--------------------------------------	--

FRP/FRS SERIES RADIANT HEATERS

ELEMENTS					REFLECTOR			
								
PART NUMBER	TYPE	VOLTS	WATTS	USED WITH FIXTURE	5007-2003-000	5007-2003-001	5007-2003-002	
2MS08208 2MS08240 2MS08277 2MS08347 2MS08480 2MS08600	METAL SHEATH	208 240 277 347 480 600	850	RP22 RS2 RP32 RS32	RP223ASA RS223ASA	RP233ASA RS233ASA	RP243ASA RS243ASA	
2QT10208 2QT10240 2QT10277 NA	QUARTS TUBE	208 240 277 NA	1000		5007-2010-000 RP2235A RS2235A	5007-2010-001 RP2335A RS2335A	5007-2010-002 RP2435A RS2435A	
2QL16208 2QL16240 2QL16277 2QL16347 2QL16480 2QL16600	QUARTS LAMP	208 240 277 347 480 600	1600		5007-2011-000 RP226ASA RS226ASA	5007-2011-001 RP236ASA RS236ASA	5007-2011-002 RP246ASA RS246ASA	
3MS15208 3MS15240 3MS15277 3MS15347 3MS15480 3MS15600	METAL SHEATH	208 240 277 347 480 600	1500		RP23 RS23 RP33 RS33	5007-2008-000 RP323ASA RS323ASA	5007-2008-001 RP333ASA RS333ASA	5007-2008-002 RP343ASA RS343ASA
3QT15208 3QT15240 3QT15277 3QT15347 3QT15480 3QT15600	QUARTS TUBE	208 240 277 347 480 600	1500			5007-2017-000 RP3235A RS3235A	5007-2017-001 RP3335A RS3335A	5007-2017-002 RP3435A RS3435A
3QL25208 3QL25240 3QL25277 3QL25347 3QL25480 3QL25600	QUARTS LAMP	208 240 277 347 480 600	2500			5007-2018-000 RP326ASA RS326ASA	5007-2018-001 RP336ASA RS336ASA	5007-2018-002 RP346ASA RS346ASA
4MS20208 4MS20240 4MS20277 4MS20347 4MS20480 4MS20600	METAL SHEATH	208 240 277 347 480 600	2000	5007-2016-000 RP326SA RP329SA RS326SA RS329SA		5007-2016-001 RP336SA RP339SA RS336SA RS339SA	5007-2016-002 RP346SA RP349SA RS346SA RS349SA	
4QT20208 4QT20240 4QT20277 4QT20347 4QT20480 4QT20600	QUARTS TUBE	208 240 277 347 480 600	2000					
4QL36347 4QL36480 4QL36600	QUARTS LAMP	347 480 600	3650					
					ELEMENT TERM BUSH*		TERMINAL BLOCK*	
					ALL MODELS 1213-0070-000		ALL MODELS 1224-0049-000	
					NOTES * FOUR REQUIRED ON 2 ELEMENT AND SIX FOR 3 ELEMENT FIXTURES			
					 			

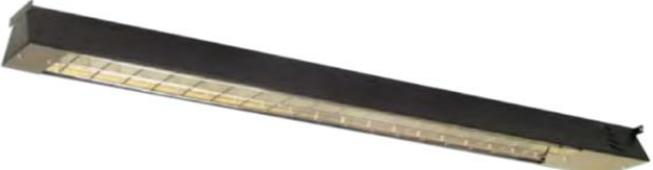

HRK SERIES

ELEMENT		REFLECTOR	
			
1802-2113-501 RK41512A	1802-2113-515 RK53020A	5007-2013-000 RK41512A RK42020A RK42024A RK42027A RK42034A RK42048A RK42060A	5007-2013-001 RK53020A RK53024A RK53027A RK53034A RK53048A RK53060A
1802-2113-509 RK42020A	1802-2113-516 RK53024A		
1802-2113-510 RK42024A	1802-2113-517 RK53027A		
1802-2113-511 RK42027A	1802-2113-518 RK53034A		
1802-2113-512 RK42034A	1802-2113-519 RK53048A		
1802-2113-513 RK42048A	1802-2113-520 RK53060A		
1802-2113-514 RK42060A			
CHAIN 2 REQ.	"S" HOOK 4 REQ.		
			
1404-2000-001 ALL MODELS	2706-2000-000 ALL MODELS	1402-2275-000 ALL MODELS	1402-2275-001 ALL MODELS
			

RCC COVE HEATERS (C & D SERIES)

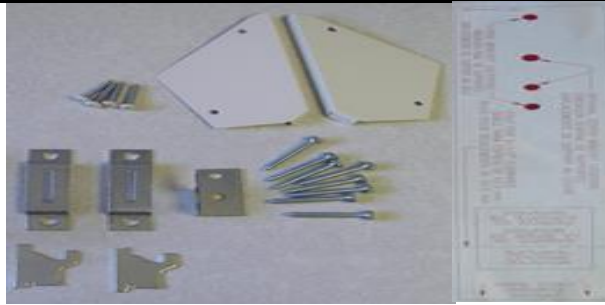
PARTS KIT*

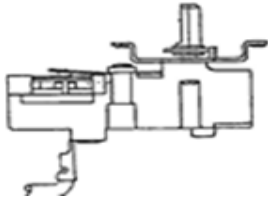

WHITE 3303-2032-000	DOVE GRAY 3303-2032-001	DESERT TAN 3303-2032-002
CENTER SUP BRACKET**	THERMOSTAT	THERMOSTAT KNOB
		
ALL MODELS 1215-2309-000	ALL MODELS 410129001	ALL MODELS 3301-2020-006













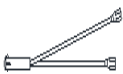

NOTES

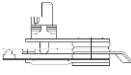

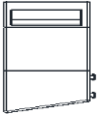

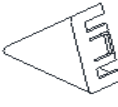





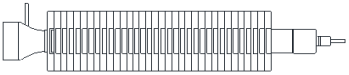
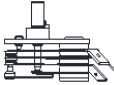

REPLACE HEATER IF FRONT COVER OR ELEMENT IS NEEDED

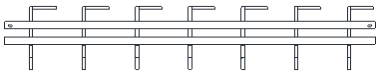
*** PARTS KIT INCLUDES MOUNTING BRACKETS, MOUNTING TEMPLATE, AND END CAPS**





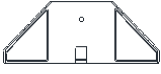

**** 1500 & 1800 WATT MODELS TAKE TWO CENTER SUPPORT BRACKETS**

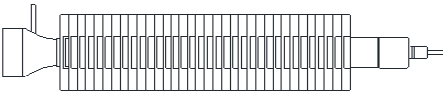

FBE SERIES					
ELEMENT		SWITCH			LIGHT
					
1802-2087-000 FBE15002C FBE15002CA		5216-2007-000 FBE1000A FBE1200 FBE1250A	5216-2010-000 FBE15002 FBE15002A	5216-2027-000 FBE15002B FBE15002C FBE15002CA	3510-2008-001 FBE1504C
LIMIT	THERMOSTAT	KNOB		FACE PLATE	
					
4520-2011-004 FBE1500C FBE15002A FBE15002B FBE15002C FBE15002CA	5813-2058-001 FBE1200 FBE1200C FBE1500C FBE15002B FBE15002C FBE15002CA FBE1504C	3301-2017-000 FBE1000A FBE1250A FBE15002 FBE15002A	3301-2011-003 FBE1200 FBE1200C FBE1500C FBE15002B FBE15002C FBE15002CA FBE1504C	1402-2122-139 FBE1000A	1402-2122-136 FBE15002
				1402-2122-141 FBE1200	1402-2122-138 FBE15002A
				1402-2122-125 FBE1200C	1402-2122-142 FBE15002B
				1402-2122-140 FBE1250A	1402-2122-626 FBE15002CA
END CAP RIGHT	END CAP LEFT	LEG RIGHT	LEG LEFT	CORD	CONTROL COVER
					
1800-2047-001 FBE1200C FBE1500C FBE15002C FBE15002CA FBE1504C	1800-2048-001 FBE1200C FBE1500C FBE15002C FBE15002CA FBE1504C	3507-2004-001 FBE1200C FBE1500C FBE15002C FBE15002CA FBE1504C	3507-2005-001 FBE1200C FBE1500C FBE15002C FBE15002CA FBE1504C	1420-2027-001 FBE15002C 1420-11013-000 FBE15002CA	1402-2243-001 FBE15002B FBE15002C FBE15002CA
					

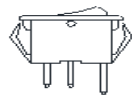
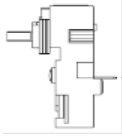
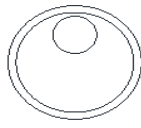

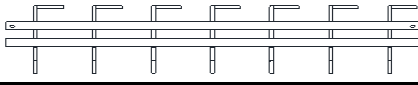
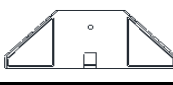



LFP SERIES (OBSOLETE)					
ELEMENT		THERMOSTAT		LIMIT	
					
1802-2067-023 LFP6152D LFP6152E LFP6152EA		5813-2019-000 LFP6152 LFP6152D LFP6152E LFP6152EA		410163004 LFP6152 LFP6152D LFP6152E LFP6152EA	
1802-2067-001 LFP675D		5813-2001-000 LFP675 LFP675D		4520-2010-001 LFP675 LFP675D	
GRILLE	LIGHT	DIODE BRIDGE	FRONT COVER	CORD	
					
2501-2012-015 LFP6152 LFP6152D LFP6152E LFP6152EA	2501-2012-013 LFP675 LFP675D	3510-2006-000 LFP6152 LFP6152D LFP6152E LFP6152EA	DBKIT LFP6152 LFP6152D LFP6152E LFP6152EA	1402-2066-609 LFP6152EA	
1420-11013-000 LFP6152D LFP6152E LFP6152EA					
KNOB	LEG	SWITCH	END CAP		
					
3301-2011-001 LFP6152 LFP6152D LFP6152E LFP6152EA LFP675 LFP675D	3507-2003-000 LFP6152 LFP6152D LFP6152E LFP6152EA LFP675 LFP675D	5216-2007-000 LFP6152 LFP6152D LFP6152E LFP6152EA LFP675 LFP675D	1800-2027-000 LFP6152 LFP6152D LFP6152E LFP6152EA LFP675 LFP675D		

FHP SERIES





ELEMENT		LIMIT		SWITCH
				
1802-2067-001 FHP0750KCT FHP0750KCTA FHP0750T FHP0750TA	1802-2067-023 FHP1500KCT FHP1500KCTA FHP1500T FHP1500TA	4520-0011-000 FHP0750KCT FHP0750KCTA FHP0750T FHP0750TA	410163004 FHP1500KCT FHP1500KCTA FHP1500T FHP1500TA	5216-11020-000 FHP0750KCT FHP0750KCTA FHP0750T FHP0750TA FHP1500KCT FHP1500KCTA FHP1500T FHP1500TA
THERMOSTAT	KNOB	FRONT COVER		END CAP
				
5813-11012-000 FHP0750KCT FHP0750KCTA FHP0750T FHP0750TA FHP1500KCT FHP1500KCTA FHP1500T FHP1500TA	3301-2011-005 FHP0750KCT FHP0750KCTA FHP0750T FHP0750TA FHP1500KCT FHP1500KCTA FHP1500T FHP1500TA	1402-2066-607 FHP0750KCT FHP0750KCTA FHP0750T FHP0750TA	1402-2066-609 FHP1500KCT FHP1500KCTA FHP1500T FHP1500TA	1800-2027-000 FHP0750KCT FHP0750KCTA FHP0750T FHP0750TA FHP1500KCT FHP1500KCTA FHP1500T FHP1500TA
GRILLE		LEGS (2 REQ)	CORD	
				
2501-2012-013 FHP0750KCT FHP0750KCTA FHP0750T FHP0750TA	2501-2012-015 FHP1500KCT FHP1500KCTA FHP1500T FHP1500TA	3507-2003-000 FHP0750KCT FHP0750KCTA FHP0750T FHP0750TA FHP1500KCT FHP1500KCTA FHP1500T FHP1500TA	1420-11013-000 FHP0750KCT FHP0750KCTA FHP0750T FHP0750TA FHP1500KCT FHP1500KCTA FHP1500T FHP1500TA	





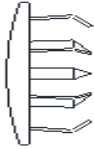
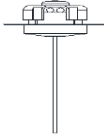
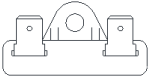
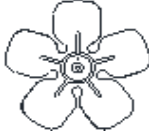

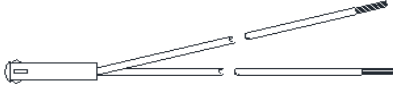
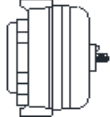
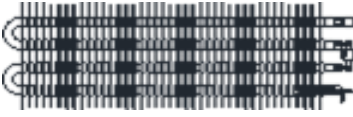







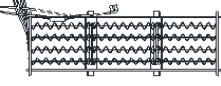



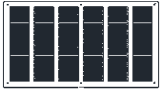

DOE INDUSTRIAL & COMMERCIAL CEILING FANS

			ASSEMBLY HAS SHACKLE AND RUBBER ROLLER					
MODEL	BLADES SET OF 3	MOTOR	DOWN ROD	SHACKLE	UPPER CANOPY	LOWER CANOPY	RUBBER ROLLER	SPEED CONTROL
56001HP	9B5600-1HP	9M5600-1HP	9D24BW	9F2900-03A	9F2900-07A	9F2900-08A	9F2900-04A	12003
56001HP-BRN	9B5600-1HPB		9D24BB	9F2900-03A	9FP029	9FP030	9F2900-04A	12003
56001HPDOE-K	9B5600-1HP	9M5600-1HP	9D24BW	9F2900-03A	9F2900-07A	9F2900-08A	9F2900-04A	12003
56001HPDOEBRN-K	9B5600-1HPB		9D24BB	9F2900-03A	9FP029	9FP030	9F2900-04A	12003
56001LCCDOE	9B5600-1LCC	9M5600-1LCC	9D24BW	9F2900-03A	9F2900-07A	9F2900-08A	9F2900-04A	CTL12004RSPDDOE
56001LCCDOE-K	9B5600-1LCC	9M5600-1LCC	9D24BW	9F2900-03A	9F2900-07A	9F2900-08A	9F2900-04A	CTL12004RSPDDOE
56201CLSDOE	9B56201CLS-1	9M56201CLS-1	9D24BW	9F2900-03A	9F2900-07A	9F2900-08A	9F2900-04A	CTL12004RSPDDOE
56201CLSDOE-K	9B56201CLS-1	9M56201CLS-1	9D24BW	9F2900-03A	9F2900-07A	9F2900-08A	9F2900-04A	CTL12004RSPDDOE
56007HPDOE	9B5600-7HP	9M5600-7HP	9D24BW	9F2900-03A	9F2900-07A	9F2900-08A	9F2900-04A	27708
56007HPDOE-K	9B5600-7HP	9M5600-7HP	9D24BW	9F2900-03A	9F2900-07A	9F2900-08A	9F2900-04A	27708
60001HPDOE	9B6000-1HP	9M6000-1HP	9D24BW	9F2900-03A	9F2900-07A	9F2900-08A	9F2900-04A	12003
60001HPDOE-BRN	9B6000-1HPB		9D24BB	9F2900-03A	9FP029	9FP030	9F2900-04A	12003
60001HPDOE-K	9B6000-1HP	9M6000-1HP	9D24BW	9F2900-03A	9F2900-07A	9F2900-08A	9F2900-04A	12003
60001HPDOEBRN-K	9B6000-1HPB		9D24BB	9F2900-03A	9FP029	9FP030	9F2900-04A	12003
36201DOE	9B3620-1C	9M3620-1C	9D24BB	9F2900-03A	9F2900-07A	9F2900-08A	9F2900-04A	CTL12004RSPDDOE
36201DOE-K	9B3620-1C	9M3620-1C	9D24BB	9F2900-03A	9F2900-07A	9F2900-08A	9F2900-04A	CTL12004RSPDDOE
48201DOE	9B48201-1C	9M48201-1C	9D24BB	9F2900-03A	9F2900-07A	9F2900-08A	9F2900-04A	CTL12004RSPDDOE
48201DOE-K	9B48201-1C	9M48201-1C	9D24BB	9F2900-03A	9F2900-07A	9F2900-08A	9F2900-04A	CTL12004RSPDDOE

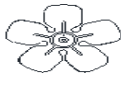
J HOOK KIT	MODELS ENDING IN K COME WITH SPEED CONTROL		
	VARIABLE SP. CONTROL	VOLTS	AMPS
	12003	120	3
	12006	120	6
	12008	120	8
	12012	120	12
	27708	277	8
9F2900-01			
ALL MODELS			
	NOISELESS SP. CONTROL		
	12001N	120	1
	12005N	120	5
	REVERSING SP. CONTROL		
	CTL12004RSPDDOE	120	4

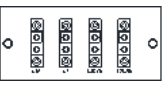

MCSSAR SERIES (OBSOLETE)					
KNOB	PLUG BUTTON	MANUAL RESET	THERMAL FUSE	FAN BLADE	THERMOSTAT
					
3301-11013-000 ALL MODELS	4506-2012-009 ALL MODELS	4520-11019-000 ALL MODELS	4520-2030-000 ALL MODELS	490030103 ALL MODELS	5813-2027-001 ALL MODELS
FAN DELAY			LIGHT		
					
1414-2039-000 MCARWH1802 MCARWH1802AL MCARWH1802BZ MCARWH1802W	410074000 MCARWH4804 MCARWH4804AL MCARWH4804BZ MCARWH4804W MCARWH4807 MCARWH4807AL MCARWH4807AL	MCARWH4807BZ MCARWH4807W MCARWH4808 MCARWH4808AL MCARWH4808BZ MCARWH4808W	3510-2017-000 MCARWH1802 MCARWH1802AL MCARWH1802BZ MCARWH1802W	3510-2017-001 MCARWH4804 MCARWH4804AL MCARWH4804BZ MCARWH4804W MCARWH4807 MCARWH4807AL	MCARWH4807BZ MCARWH4807W MCARWH4808 MCARWH4808AL MCARWH4808BZ MCARWH4808W
MOTOR			ELEMENT		DISCONNECT SWITCH
					
3900-2010-003 MCARWH1802 MCARWH1802AL MCARWH1802BZ MCARWH1802W	3900-2010-000 MCARWH4804 MCARWH4804AL MCARWH4804BZ MCARWH4804W MCARWH4808 MCARWH4808AL MCARWH4808BZ MCARWH4808W	3900-2010-001 MCARWH4807 MCARWH4807AL MCARWH4807BZ MCARWH4807W	302012828 MCARWH1802 MCARWH1802AL MCARWH1802BZ MCARWH1802W 302012811 MCARWH4807 MCARWH4807AL MCARWH4807BZ MCARWH4807W	302012810 MCARWH4804 MCARWH4804AL MCARWH4804BZ MCARWH4804W 302012807 MCARWH4808 MCARWH4808AL MCARWH4808BZ MCARWH4808W	410170001 ALL MODELS 

QFG-SERIES																	
KNOB		GRILLE		BLOWER ASM				CLIP N FIT BOARD		THERMOSTAT							
																	
3301-2040-001 G1512T2M G2024T2M G1512T2MA G2024T2MA G2224T2MA G1512T2MB G2024T2MB G2224T2MB G1512T2MC G2024T2MC G2224T2MC		2501-2046-000 ALL MODELS		1225-2002-000 G1012IF G1512IF G1512M G1512T2M G1512IFMA G1512MA G1512T2MA G1512IFMB G1512MB G1512T2MB G1512IFMC G1512T2MC		1225-2002-001 G1024IF G1524IF G2024IF G2024M G2028IF G2224IF G2224M G2024IFMA G2024MA G2024T2MA G2028IFA G2224IFMA G2224MA		1225-2002-001 G2224T2MA G2024IFMB G2224T2MB G2024MB G2024T2MB G2028IFB G2224T2MC G2224IFC G2024FMC G2024T2MC		1249-2005-000 G1512M G1512T2M G2024M G2024T2M G2224M G1512MA G1512T2MA G2024IFMA G2024MA G2024T2MA G2224IFMA G2224MA G2224T2MA G1512IFMB		G1512MB G1512T2MB G2024IFMB G2024MB G2024T2MB G2228IFB G2224IFMB G2224T2MB G1512IFMC G1512T2MC G2024IFMC G2024T2MC G2224IFC G2224T2MC G2228IFC		410130001 G1512T2M G1512T2MA G1512T2MB G2024T2M G2024T2MA G2224T2MA G2024T2MB G2224T2MB G1512T2MC G2024T2MC G2224T2MC			
ELEMENT 				HI LIMIT 				LIGHT 									
1802-2124-005 G1024IF G2024IF		1802-2124-000 G1512IF G1512IFMA		4520-11012-000 G1512IFMC G1512T2MC		4520-11012-001 G2024IFMC G2024T2MC G2224IFC G2224T2MC G2228IFC		4520-2059-000 G1012IF G1512IF G1512M G1512T2M G1512IFMA G1512MA G1512T2MA G1512IFMB G1512MB G1512T2MB G1024IF G1524IF G2024M G2024T2M G2224IFMB G2028IFB G2224IFMB G2224T2MB		3510-2017-000 G1012IF G1512IF G1512M G1512T2M G1512IFMA G1512MA G1512T2MA G1512IFMB G1512MB G1512T2MB		3510-2017-001 G1024IF G1524IF G2024IF G2024M G2024T2M G2028IF G2224IF G2224M G2024IFMA G2024MA G2024T2MA G2224IFC G2224T2MC G2028IFA G2224IFC G2224MA G2224T2MA		G2024IFMB G2024MB G2024T2MB G2028IFB G2224IFMB G2224T2MB G2024IFMC G2024T2MC G2224IFC G2224T2MC G2024IFMC G2024T2MC G2224IFC G2224T2MC G2024IFMC G2024T2MC G2224IFC G2224T2MC G2224IFC G2224T2MC			
1802-2125-000 G1512IFMB G1512MB G1512T2MB G1512IFMC G1512T2MC		1802-2125-002 G2024IFMB G2024MB G2024T2MB G2024IFMC G2024T2MC				G1512MA G2024T2MA G2028IFA G2224IFMA G2224MA G2224T2MA G2024IFMB G2024MB G2024T2MB G2024M G2028IFB G2224IFMB G2224T2MB		G1512IFMA G2024MA G2024T2MA G2028IFA G2224IFMA G2224MA G2224T2MA G2024IFMB G2024MB G2024T2MB G2024M G2028IFB G2224IFMB G2224T2MB		G1512IFMA G1512MA G1512T2MA G1512IFMB G1512MB G1512T2MB		G2024IF G2024M G2024T2M G2224IFMB G2224T2MB		G2024IFMB G2024MB G2024T2MB G2024M G2028IFB G2224IFMB G2224T2MB		G2024IF G2024M G2024T2M G2224IFMB G2224T2MB	
1802-2124-001 G2028IFB		1802-2125-001 G2224IFMB G2224IFC G2224T2MC															
1802-2125-006 G2228IFB G2228IFC		G2224IFMB G2224IFC G2224T2MC															



EFQ-SERIES						
GRILLE	ELEMENTS (2 REQ)			MOTOR (2 REQ)		
						
2501-2027-000 ALL MODELS	302012819 Q6003	302012821 Q8003	302012809 Q6004 Q8007	3900-2010-000 Q6003 Q6004 Q60048 Q6006 Q6008 Q8003 Q8004 Q80048 Q8006 Q8008	3900-2010-001 Q6007 Q8007	
	302012820 Q6006 Q8006	302012826 Q80048	302012806 Q6007			
	302012825 Q60048	302012808 Q6008 Q8004	302012807 Q8008			
THERMOSTAT	FAN BLADE (2 REQ)	DISCONNECT SW.	TERMINAL BOARD			
						
410168002 (2REQ.) Q6003 Q60048 Q6006 Q8003 Q80048 Q8006	5813-0023-000 Q6004 Q6007 Q6008 Q8004 Q8007 Q8008	490030103 ALL MODELS	5216-2025-000 ALL MODELS	5823-2002-000 ALL MODELS		
TRANSFORMER		FAN DELAY (2 REQ)		MANUAL LIMIT (2 REQ)		
						
490015017 Q6003 Q8003	490015022 Q60048 Q80048	490015013 Q6006 Q8006	410074000 ALL MODELS	4520-2027-000 ALL MODELS		

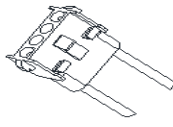
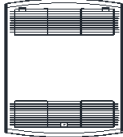
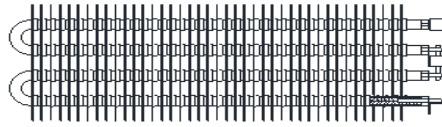
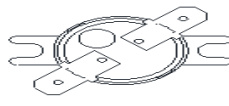





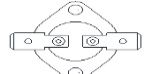
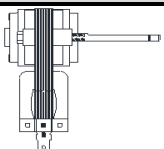



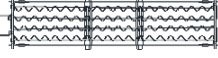

ECP SERIES (OBSOLETE)

PLUG ASSY FEMALE	GRILLE	ELEMENT		LIMIT
				
<p>1016-0114-000 ALL MODELS</p>	<p>2501-2082-000 ALL MODELS</p>	<p>302012808 ECP1024</p>	<p>302012803 ECP1524</p>	<p>4520-2025-001 ALL MODELS</p>
				







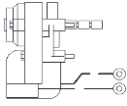
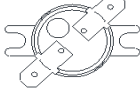

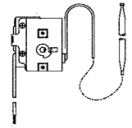
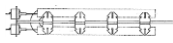
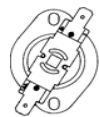
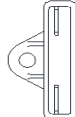
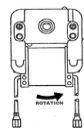
AFA SERIES (OBS)

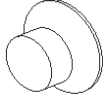

ELEMENTS					LIMIT			
								
1802-2021-000		1802-2021-003		1802-2021-004		4520-2023-000		
A1000IF	A1500IF	A1504IF	A1004IF	A2004T2B	A1000IF	A1500IFBNW	A2004IFB	
A1000IFA	A1500IFA	A1504IFA	A1004IFA	A2004T2BNW	A1000IFB	A1500T	A2004IFBNW	
A1000IFB	A1500IFB	A1504IFB	A1004IFB	A2404IF	A1000IFBNW	A1500T2B	A2004T	
A1000IFBNW	A1500IFBNW	A1504IFBNW	A1004IFBNW	A2404IFA	A1000T	A1500T2BNW	A2004T2B	
A1000T	A1500T	A1504T	A2004IF	A2404IFB	A1000T2B	A1504IF	A2004T2BNW	
A1000TA	A1500TA	A1504TA	A2004IFA	A2404IFBNW	A1000T2BNW	A1504IFB	A2404IF	
A1000T2	A1500T2	A1504T2	A2004IFB	A2404T	A1004IF	A1504IFBNW	A2404IFB	
A1000T2B	A1500T2B	A1504T2B	A2004IFBNW	A2404TA	A1004IFB	A1504T	A2404IFBNW	
A1000T2BNW	A1500T2BNW	A1504T2BNW	A2004T	A2404T2	A1004IFBNW	A1504T2B	A2404T	
			A2004TA	A2404T2B	A1500IF	A1504T2BNW	A2404T2B	
			A2004T2	A2404T2BNW	A1500IFB	A2004IF	A2404T2BNW	
MOTOR					THERMOSTAT			
								
3900-2017-000		3900-2017-001			5813-2001-000		5813-2015-000	
A0500IFA	A1000T2	A0504IFA	A1504IF	A2004TA	A0504TA	A0504T2	A1500T2BNW	
A0500IFB	A1000T2B	A0504IFB	A1504IFA	A2004T2	A1000T	A0504T2B	A1504T2B	
A0500IFBNW	A1000T2BNW	A0504IFBNW	A1504IFB	A2004T2B	A1000TA	A0504T2BNW	A1504T2BNW	
A0750IFA	A1500IF	A0504TA	A1504IFBNW	A2004T2BNW	A1500T	A1000T2	A2004T2	
A0750IFB	A1500IFA	A0504T2	A1504T	A2404IF	A1500TA	A1000T2B	A2004T2B	
A0750IFBNW	A1500IFB	A0504T2B	A1504TA	A2404IFA	A1504T	A1000T2BNW	A2004T2BNW	
A1000IF	A1500IFBNW	A0504T2BNW	A1504T2	A2404IFB	A1504TA	A1500T2	A2404T2B	
A1000IFA	A1500T	A0754IFA	A1504T2B	A2404IFBNW	A1504T2	A1500T2B	A2404T2BNW	
A1000IFB	A1500TA	A0754IFB	A1504T2BNW	A2404T	A2004T			
A1000IFBNW	A1500T2	A0754IFBNW	A2004IF	A2404TA	A2004TA			
A1000T	A1500T2B	A1004IF	A2004IFA	A2404T2	A2404T			
A1000TA	A1500T2BNW	A1004IFA	A2004IFB	A2404T2B	A2404TA			
		A1004IFB	A2004IFBNW	A2404T2BNW	A2404T2			
		A1004IFBNW	A2004T					

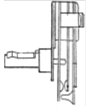
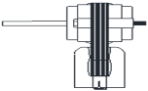





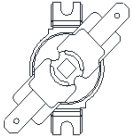
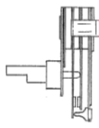
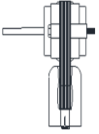



CRA SERIES									
KNOB		GRILLE	LIGHT				ELEMENT		
									
3301-2039-002		2501-2065-000	3510-2017-000	3510-2017-001	3510-2017-002	3510-2017-003	1802-2124-005	1802-2124-000	1802-2124-003
C1012T2 C1024T2 C1512T2 C1524T2 C2024T2 C2028T2 C2224T2 C1012T2A C1024T2A C1512T2A C1524T2A C2024T2A C2028T2A C2224T2A	C1012T2AA C1512T2AB C1012T2AB C1024T2AB C1512T2AB C1524T2AB C2024T2AB C2028T2AB C2224T2AB C1512T2A C1512T2B C2024T2B C2224T2B C1512T2A C1512T2B C2024T2B C2224T2B C1512T2C C2024T2C C2028T2C C2224T2C	C1512FB C1512T2B C2024FB C2024T2B C2028FB C2224FB C2224T2B C1512FC C1512T2C C2024FC C2024T2C C1512FA C1512T2A C1512T2A C2024T2A C2028T2A C2224T2A C1012FAA C1012T2AA C1512FAA C1512T2AA C1512T2AA C2024T2A C2028T2A C2224T2A C1012FAB C1012T2AB C1512FAB C1512T2AB C1512T2B C1512T2C	C1012IF C1012T2 C1512IF C1512T2 C1012IFA C1012T2A C1512IFA C1512T2A C1012IFAA C1012T2AA C1512IFA C1512T2AA C1012IFAB C1012T2AB C1512IFAB C1512T2AB C1512T2B C1512T2C	C1024IF C1024T2 C1524IF C1524T2 C2024IF C2024T2 C2028IF C2028T2 C2224IF C2224T2 C1024IFA C1024T2A C1524IFA C1524T2A C2024IFA C2024T2A C2028IFA C2028T2A C2224IFA C2224T2A	C1512IFAB C1512T2AB C1512IFB C1512T2B C1512IFC C1512T2C	C1024IFAB C1024T2AB C1524IFAB C1524T2AB C2024IFAB C2024T2AB C2028IFAB C2028T2AB C2224IFAB C2224T2AB C1024IFB C1024T2B C1524IFB C1524T2B C2024IFB C2024T2B C2028IFB C2028T2B C2224IFB C2224T2B	C1024IF C1024T2 C2024IF C2024T2 C1024IFA C1024T2A C1524IFA C1524T2A C2024IFA C2024T2A C1012IFA C1012T2A C1512IFA C1512T2A C1012IFAA C1012T2AA C1512IFAB C1512T2AB C1512IFB C1512T2B C1512T2C	C1512IF C1512T2 C1024IFA C1024T2A C2024IFA C2024T2A C2028IFA C2028T2A C2224IFA C2224T2A C2024IFB C2024T2B C2028IFB C2028T2B C2224IFB C2224T2B	C1012IFA C1012T2A 1802-2124-001 C2028IFA C2028T2A C1512IFB C1512T2B C1512T2C C2028IFA C2028T2A
FAN BLADE		MOTOR			HI LIMIT			CLIP N FIT BOARD	
									
1210-2008-000 ALL MODELS		3900-2017-000	3900-2017-001	3900-2035-000	4520-11007-000	4520-11007-001	4520-2059-000		1249-2005-000
	C1012IF C1012T2 C1512IF C1512T2 C1012IFA C1012T2A C1512IFA C1512T2A C1012IFAA C1012T2AA C1512IFAB C1512T2AB C1012IFAB C1012T2AB C1512IFAB C1512T2AB C1512T2B C1512T2C	C1012IF C1024T2 C1524IF C1524T2 C2024IF C2024T2 C2028T2A C1024IFA C1024T2A C1524IFA C1524T2A C1024IFAB C1524IFAB C1024T2AB C1524T2AB C2024IFAB C1024T2AB C1524IFAB C1524T2AB C2024IFAB C2024T2B C2024T2B C2024IFC C2024T2C	C1024IF C1024T2 C2224IF C2224T2 C2028IFA C2028T2A C2224IFA C2224T2A C1524IFA C1524T2A C2028IFAB C2224IFAB C2224T2B C2028IFC C2028T2B C2224IFC C2224T2C	C2028IF C2028T2 C2224IF C2224T2 C2028IFA C2028T2A C2224IFAB C2224T2AB C2028IFB C2224IFB C2224T2B C2028IFC C2028T2C	C1512IFC C1512T2C	C2024IFC C2024T2C C2028IFC C2224IFC C2224T2C	C1012IF C1012T2 C1512IF C1512T2 C1012IFA C1012T2A C1512IFA C1512T2A C1512T2A C1012IFAA C1012T2AA C1512IFAB C1512T2AB C1512T2A C1012IFAB C1012T2AB C1512IFAB C1512T2AB C1512IFB C1512T2B C1024IF C1024T2 C1524IF C1524T2	C2024IFA C2224T2A C2028IFAB C2224IFAB C2224T2AB C2028IFB C2224IFB C2224T2B	C1512IFB C1512T2B C1512T2C C2024IFC C2024T2C C2028IFC C2224IFC C2224T2C
THERMOSTAT		THERMAL FUSE							
									
410130001		5813-2090-000			4520-2030-000				
C1012T2 C1512T2 C1012T2A C1512T2A C1012T2AA C1512T2AA C1024T2 C1524T2 C2024T2 C1024T2A C1524T2A C2024T2A C2028T2 C2224T2 C2028T2A C2224T2A	C1012T2AB C1512T2AB C1512T2B C1512T2C C1024T2AB C1524T2AB C2024T2AB C2024T2B C2024T2C C2224T2AB C2224T2C	C1012FAA C1012T2AA C1512FAA C2024T2A C1024IFAB C1524IFAB C1524T2AB C2024IFAB C1024T2AB C1524IFAB C1524T2AB C2024IFAB C2024T2B C2024T2B C2024IFC C2024T2C	C1512IFB C1512T2B C2024IFB C2024T2B C2028IFB C2224IFB C2224T2B C1512IFC C1512T2C C2024T2B C2028IFB C2224IFB C2224T2B	C1512IFB C1512T2B C2024IFB C2024T2B C2028IFB C2224IFB C2224T2B C1512IFC C1512T2C C2024T2B C2028IFB C2224IFB C2224T2B	C1512IFB C1512T2B C2024IFB C2024T2B C2028IFB C2224IFB C2224T2B C1512IFC C1512T2C C2024T2B C2028IFB C2224IFB C2224T2B	C1512IFB C1512T2B C2024IFB C2024T2B C2028IFB C2224IFB C2224T2B C1512IFC C1512T2C C2024T2B C2028IFB C2224IFB C2224T2B	C1512IFB C1512T2B C2024IFB C2024T2B C2028IFB C2224IFB C2224T2B C1512IFC C1512T2C C2024T2B C2028IFB C2224IFB C2224T2B	C1512IFB C1512T2B C2024IFB C2024T2B C2028IFB C2224IFB C2224T2B C1512IFC C1512T2C C2024T2B C2028IFB C2224IFB C2224T2B	

QVP					
MOTOR				LIMIT	
					
42528-052-01		42528-052-02		4520-2025-000	
VP1222	VP1222I	VP2022	VP2022I	VP1222C	VP2022IC
VP1222A	VP1222IB	VP2022A	VP2022IB	VP1222CNW	VP2022ICNW
VP1222AI	VP1222IBP	VP2022AI	VP2022IBP	VP1222IC	VP2422C
VP1222B	VP1222IC	VP2022B	VP2022IC	VP1222ICNW	VP2422CNW
VP1222C	VP1222ICNW	VP2022C	VP2022ICNW	VP2022C	VP2422IC
VP1222CNW		VP2022CNW		VP2022CNW	VP2422ICNW









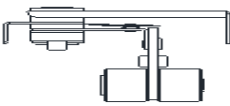

A2500					
THERMOSTAT	ELEMENT	LIMIT	THERMAL FUSE	GRILLE	MOTOR
				PICTURE NOT AVAILABLE	
4230-8232	6101-8752	8541-8056	8671-8037	8683-8272	8767-8036
A2515T	A2530T	A2515T	A2515T	A2515T	A2515T
A2520T		A2520T	A2520T	A2520T	A2520T
A2530T		A2530T	A2530T	A2530T	A2530T
A2540T		A2540T	A2540T	A2540T	A2540T
A2548T		A2548T	A2548T	A2548T	A2548T

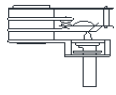
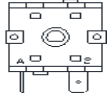
1235 & 2435 SERIES (OBS)					
SCREEN		KNOB	FACE PLATE	LIMIT	
					
1235-0037 1235 2435	8850-8046 1235P 2435P	3301-2047-000 ALL MODELS	4503-2094-000 ALL MODELS	8541-8054 ALL MODELS	
THERMOSTAT	MOTOR	FAN BLADE	ELEMENT	THERMAL FUSE	
					
1230-8194 ALL MODELS	1235-0007 ALL MODELS	1235-0008 ALL MODELS	6101-8741 ALL MODELS	8671-8036 2435 2435P	

B2400 SERIES (OBS)			
ELEMENT		LIMIT	THERMOSTAT
			
6101-8741 B2451	6101-8742 B2452	8541-8055 ALL MODELS	1230-8206 ALL MODELS
MOTOR		FAN BLADE	THERMAL FUSE
			
8767-8035 B2451	8767-8036 B2452	991-313 ALL MODELS	8671-8037 B2452

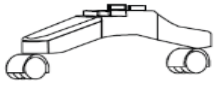

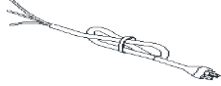







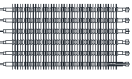

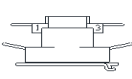

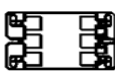

CWH2000								
ELEMENT						BLADE		
								
302023801 CWH2101 CWH2101A CWH2101B CWH2101BWW CWH2101DS CWH2101DSB CWH2101DSBWW CWH2101DSBWW CWH2101F	302023802 CWH2151 CWH2151A CWH2151B CWH2151BWW CWH2151DS CWH2151DSB CWH2151DSBWW CWH2151F	302023803 CWH2157 CWH2157A CWH2157B CWH2157BWW CWH2157DSBWW CWH2157F	302023804 CWH2208 CWH2208A CWH2208B CWH2208BWW CWH2208SBNW CWH2208F	302023805 CWH2202 CWH2202A CWH2202B CWH2202BWW CWH2202DS CWH2202DSB CWH2202DSBWW CWH2202F	302023806 CWH2207 CWH2207A CWH2207B CWH2207BWW CWH2207DS CWH2207DSB CWH2207DSBWW CWH2207F	302023808 CWH2201 CWH2201A CWH2201B CWH2201BLT CWH2201BWW CWH2201DS CWH2201DSB CWH2201DSBWW CWH2201F	490061001 ALL MODELS	
MOTOR				THERMOSTAT				KNOB
								
490062001 CWH2101 CWH2101A CWH2101B CWH2101BWW CWH2101DS CWH2101DSB CWH2101DSBWW CWH2101F CWH2151 CWH2151A CWH2151B CWH2151BWW CWH2151DS	CWH2151DSB CWH2151DSBWW CWH2151F CWH2201 CWH2201A CWH2201B CWH2201BLT CWH2201BWW CWH2201DS CWH2201DSB CWH2201DSBWW CWH2201F	490062002 CWH2208 CWH2208A CWH2208B CWH2208BWW CWH2208SBNW CWH2208F	490062003 CWH2202 CWH2202A CWH2202B CWH2202BWW CWH2202DS CWH2202DSB CWH2202DSBWW CWH2202F	490062004 CWH2257 CWH2257A CWH2257B CWH2257BWW CWH2257F CWH2207 CWH2207A CWH2207B CWH2207BWW CWH2207DS CWH2207DSB CWH2207DSBWW CWH2207F	5813-2001-000 CWH2101 CWH2101A CWH2101B CWH2101BWW CWH2101DS CWH2101DSB CWH2101DSBWW CWH2101F CWH2151 CWH2151A CWH2151B CWH2151BWW CWH2151DS CWH2151DSB CWH2151DSBWW CWH2151F CWH2157 CWH2157A CWH2157B CWH2157BWW CWH2157DSBWW CWH2157F	CWH2202 CWH2202A CWH2202B CWH2202BWW CWH2202DS CWH2202DSB CWH2202DSBWW CWH2202F CWH2207 CWH2207A CWH2207B CWH2207BWW CWH2207DS CWH2207DSB CWH2207DSBWW CWH2207F CWH2208 CWH2208A CWH2208B CWH2208BWW CWH2208DSBWW CWH2208F	5813-2022-000 CWH2201 CWH2201A CWH2201B CWH2201BWW CWH2201DS CWH2201DSB CWH2201DSBWW CWH2201F	3301-2001-000 MODELS W/THERMOSTAT
FAN DELAY		LIMIT		MANUAL RESET	LIGHT		DISCONNECT SW	
								
410074000 CWH2101 CWH2101B CWH2101BWW CWH2101DS CWH2101DSB CWH2101DSBWW CWH2101F CWH2151 CWH2151B CWH2151BWW CWH2151DS CWH2151DSB CWH2151DSBWW CWH2151F CWH2157 CWH2157B CWH2157BWW CWH2157DSBWW CWH2157F CWH2201 CWH2201B CWH2201BLT CWH2201BWW	CWH2201DSB CWH2201DSBWW CWH2202 CWH2202B CWH2202BWW CWH2202DS CWH2202DSB CWH2202DSBWW CWH2202F CWH2207 CWH2207B CWH2207BWW CWH2207DS CWH2207DSB CWH2207DSBWW CWH2208 CWH2208A CWH2208B CWH2208BWW CWH2208DSBWW CWH2208F	1414-2009-000 CWH2101A CWH2101DS CWH2151A CWH2151DS CWH2157A CWH2201A CWH2201DS CWH2202A CWH2202DS CWH2207A CWH2207DS CWH2208A	410143000 CWH2101 CWH2101B CWH2101BWW CWH2101DS CWH2101DSB CWH2101DSBWW CWH2151 CWH2151B CWH2151BWW CWH2151DS CWH2151DSB CWH2151DSBWW CWH2151F CWH2157 CWH2157B CWH2157BWW CWH2157DSBWW CWH2201 CWH2201B CWH2201BLT CWH2201BWW	CWH2201DSB CWH2201DSBWW CWH2202 CWH2202B CWH2202BWW CWH2202DS CWH2202DSB CWH2202DSBWW CWH2202F CWH2207 CWH2207B CWH2207BWW CWH2207DS CWH2207DSB CWH2207DSBWW CWH2208 CWH2208A	4520-11016-000 CWH2101A CWH2101DS CWH2151A CWH2157A CWH2201A CWH2201DS CWH2202A CWH2202DS CWH2207A CWH2207DS CWH2208A	3510-2008-002 CWH2157B CWH22157BWW CWH2202B CWH2202BWW CWH2202DS CWH2202DSB CWH2202DSBWW CWH2207B CWH2207BWW CWH2207DS CWH2207DSB CWH2207DSBWW CWH2208B CWH2208BWW CWH2208DSBWW	3510-2008-003 CWH2101B CWH22101BWW CWH22101DS CWH22101DSB CWH22101DSBWW CWH22151B CWH22151BWW CWH22151DS CWH22151DSB CWH22151DSBWW CWH2201B CWH2201BLT CWH2201BWW CWH2201DS CWH2201DSB CWH2201DSBWW	410170001 CWH2101DS CWH2101DSB CWH2101DSBWW CWH2151DS CWH2151DSB CWH2151DSBWW CWH2201DS CWH2201DSB CWH2201DSBWW CWH2202DS CWH2202DSB CWH2202DSBWW CWH2207DS CWH2207DSB CWH2207DSBWW CWH2208DSBWW

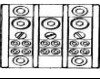
WPC SERIES (OBS)

ELEMENT	TIP OVER SW.	LIMIT	THERMOSTAT
			
1802-10822-000 WPC1500A 1802-11017-000 (500W) 1802-11017-001 (1000W) WPC1500B WPC1500C	5216-11004-000 WPC1500A	410122002 WPC1500A 4520-11004-003 WPC1500B WPC1500C	5813-2092-001 WPC1500A WPC1500B WPC1500C
4 POSITION SW.	PORT SWITCH	LIGHT RED	PILOT LIGHT AMBER
			
5216-2071-000 WPC1500A WPC1500B WPC1500C	5216-2073-000 WPC1500A WPC1500B WPC1500C	3510-2021-002 WPC1500A 3510-2021-004 WPC1500B WPC1500C	3510-11518-000 WPC1500A WPC1500B WPC1500C
WHEEL KIT (2 REQ)	HOLE PLUG (2 REQ)	CORD	KNOB (2 REQ)
			
1205-10305-000 WPC1500A WPC1500B WPC1500C	4506-2022-000 WPC1500A WPC1500B WPC1500C	1420-2029-009 WPC1500A WPC1500B WPC1500C	3301-2058-000 WPC1500A WPC1500B WPC1500C

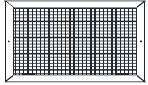

TBX SERIES (OBS)

ELEMENT	MOTOR	TIME DELAY RELAY	CONTACTOR 30AMP	CONTACTOR 50AMP	THERMOSTAT
					
302006814 TBX754	490059004 ALL MODELS	410171003 ALL MODELS	5018-0003-002 ALL MODELS	5018-0006-002 ALL MODELS	5813-2059-000 ALL MODELS
302006813 TBX104					
BLADE	HI LIMIT	TERMINAL BLOCK	TOOL BOX COVER	CORD	KNOB
					
490011001 ALL MODELS	410169001 ALL MODELS	480100001 ALL MODELS	1016-0193-800 ALL MODELS	1016-10593-000 ALL MODELS	3301-2053-000 ALL MODELS
AXLE	GRILLE	COLLAPSABLE HANDLE	HANDLE	WHEEL (2 REQ)	AXLE CAP (2 REQ)
					
1017-0004-000 ALL MODELS	2501-10513-800 ALL MODELS	2710-10586-000 ALL MODELS	2710-2012-800 ALL MODELS	6406-0002-000 ALL MODELS	1408-10584-000 ALL MODELS



CU-A & CU-B OBSOLETE							
MODEL CU-B							
CABINET SERIES	QTY.	PART NUMBER				FILTERS A & B MODELS	
		FINTUBE HEATING ELEMENT (RETANGULAR ALUMINUM FIN)				THROWAWAY	REUSABLE
		208V	240V	277V & 480V 4-WIRE	480V 3-WIRE		
1200	2						
1300	3						
1400	4	1802-0103-001	1802-0103-002	1802-0103-003	1802-0103-004	2010-7008-001	2010-7009-001
1500	5						
1600	6						
2200	2						
2300	3						
2400	4	1802-0103-005	1802-0103-006	1802-0103-007	1802-0103-008	2010-7008-002	2010-7009-002
2500	5						
2600	6						
3200	2						
3300	3						
3400	4	1802-0103-009	-	1802-0103-011	1802-0103-012	2010-7008-003	2010-7009-003
3500	5						
3600	6						
4200	2						
4300	3						
4400	4	-	1802-0103-014	-	1802-0103-016	2010-7008-004	2010-7009-004
4500	5						
4600	6						
5200	2						
5300	3						
5400	4					2010-7008-005	2010-7009-005
5500	5						
5600	6						

MODELS CU-A & CU-B							
CABINET SERIES	BLOWER WHEEL	SHAFT	BEARINGS (2 EA)	COUPLING	FAN MOTOR	HIGH LIMIT	
						ALL EXCEPT CUI	CUI MODELS ONLY
1200-1600	6406-7001-001	-	-	-	3900-0558-000	4520-0011-002	-
2200-2600	6406-7001-001	-	-	-	3900-0559-000	4520-0011-002	-
3200-3600	6406-7001-002	5217-7007-001	2011-7017-000	1410-7003-001	3900-0563-000	-	4520-0011-009
4200-4600	6406-7001-002	5217-7007-002	2011-7017-000	1410-7003-001	3900-0563-000	-	4520-0011-009
5200-5600	6406-7001-002	5217-7007-003	2011-7017-000	1410-7003-001	3900-0563-000	-	4520-0011-009

PARTS COMMON TO ALL MODELS			CIRCUIT BREAKERS			
DESCRIPTION	PART NUMBER	VOLTAGE RATING	NUMBER OF POLES	AMPS	PART NUMBERS	
FAN RELAY:				15	4520-7009-014	
24V	CUBFDRK24			20	4520-7009-015	
120V	CUBFDRK120			25	4520-7009-016	
240V	CUBFDRK240			30	4520-7009-017	
SELECTOR SWITCH	5216-0302-000		2	35	4520-7009-018	
THERMOSTAT	-			40	4520-7009-019	
STEP-DOWN TRANSFORMER	5814-7013-002			45	4520-7009-020	
BUCK-BOOST TRANSFORMER	490015007			50	4520-7009-021	
SUMMER FAN SWITCH	5216-0302-000			60	4520-7009-022	
*CONTACTORS, CU-B				15	4520-7009-008	
2 POLE/30 AMP, 24V HOLDING COIL	5018-0003-000			20	4520-7009-004	
2 POLE/30 AMP, 120V HOLDING COIL	5018-0003-001			25	4520-7009-010	
2 POLE/30 AMP, 208V/240V HOLDING COIL	5018-0003-002			30	4520-7009-005	
3 POLE/ 35 AMP, 24V HOLDING COIL	5018-0005-004		3	35	4520-7009-011	
3 POLE/ 35 AMP, 120V HOLDING COIL	5018-0005-005			40	4520-7009-006	
3 POLE/ 35 AMP, 208V/240V HOLDING COIL	5018-0005-006			45	4520-7009-012	
*CONTACTORS, CU-A				50	4520-7009-001	
2 POLE/30 AMP, 24V HOLDING COIL	5018-0004-100			60	4520-7009-007	
2 POLE/30 AMP, 120V HOLDING COIL	5018-0004-101			15	4520-7008-013	
2 POLE/30 AMP, 208V/240V HOLDING COIL	5018-0004-102			20	4520-7008-014	
3 POLE/ 50 AMP, 24V HOLDING COIL	5018-0006-000		2	25	4520-7008-015	
3 POLE/ 50 AMP, 120V HOLDING COIL	5018-0006-001			30	4520-7008-016	
3 POLE/ 50 AMP, 208V/240V HOLDING COIL	5018-0006-002			35	4520-7008-017	
				40	4520-7008-018	
				50	4520-7008-020	
				60	4520-7008-021	
				15	4520-7008-005	
				20	4520-7008-006	
			3	25	4520-7008-008	
				30	4520-7008-001	
				35	4520-7008-009	
				40	4520-7008-007	

Reference Data

HOW TO ORDER
RATING SERIES PRODUCT NUMBERS
 The last group of four numbers describe the Unit Size, Heating Capacity Voltage Rating and Type of Control:

Number of Fans and Cabinet Series are indicated by the first number.
 1 - One Fan Series 1000 Cabinet
 2 - Two Fans Series 2000 Cabinet
 3 - Three Fans Series 3000 Cabinet
 4 - Four Fans Series 4000 Cabinet
 5 - Five Fans Series 5000 Cabinet

Number of Fintube Heating Elements and the corresponding Unit Heating Capacity are indicated by the second number.

	1000	2000	Cabinet Series		
			3000	4000	5000
2 Element	2.0KW	4.0KW	5.3KW	6.7KW	8.0KW
3 Element	3.0KW	6.0KW	8.0KW	10.0KW	12.0KW
4 Element	4.0KW	8.0KW	10.7KW	13.3KW	16.0KW
5 Element	5.0KW	10.0KW	13.3KW	16.7KW	20.0KW*
6 Element	6.0KW	12.0KW	16.0KW	20.0KW	24.0KW**

Not available in all voltages. See table on page 2.

Electric Power Supply for the heating Circuit is indicated by the third number as follows:
 1 - 208V Single Phase 4 - 240V Three Phase 7 - 480V Three Phase 3 Wire
 2 - 208V Three Phase 5 - 277V Single Phase 8 - 347V Single Phase
 3 - 240V Single Phase 6 - 480V Three Phase 4 Wire 9 - 600V Three Phase

Control Supply and Circuit are defined by the fourth number.

NOTE: A thermostat either integral or remote, must be used for proper operation of heater.



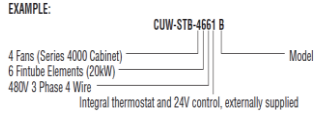

Thermostat	Voltage	Supply	For Use Only With Models
0-	Integral	120	External CUC, CUF, CUW
1-	Integral	24	External CUC, CUF, CUW
2-	Integral	208/240*	Internal CUC, CUF, CUW
3-	Remote	120	External All Models
4-	Remote	24	External All Models
5-	Remote	208/240*	Internal All Models
6-	Remote	24	Internal All Models
7-	Remote	120	Internal All Models
8-	Integral	24	Internal CUC, CUF, CUW
9-	Integral	120	Internal CUC, CUF, CUW

*Control Voltage is 208 VAC on units with 208 VAC Heating Circuit.





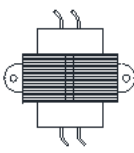

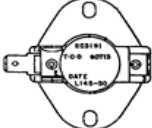
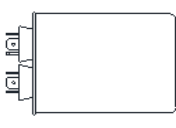





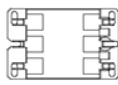
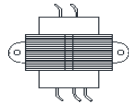



MODEL LETTER
 The letter "B" at the end of the catalog number designates the unit as a "B" model.

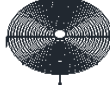
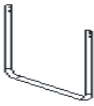
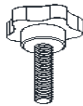

DUH & DUH-A

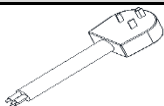

BLADE	RELAY		TRANSFORMER	
				
490020000	5018-0005-006		5018-0006-002	
H2520	H1020A	H1048A	H2520	490015018
H2524	H1024A	H1555A	H2524	H1034A
H2548	H1027A	H1560A	H2548	H1534A
H2555	H1034A	H2020	H2555	490015019
H2560	H1048A	H2024	H3020	H2034
H3020	H1055A	H2027	H3024	490015021
H3024	H1060A	H2034	H3048	H1060A
H3048	H1520A	H2048	H3055	H1560A
H3055	H1524A	H2055	H4020	490015005
H3060	H1527A	H2060	H4024	H2027
H4020	H1534A		H4048	490015008
H4024			H4055	H5048
H4048			H5020	H5055
H4055			H5024	490015012
H4060			H5060	H2060
				H2560
				H3060
				H4060
				490015015
				H5060
LIMIT	FAN DELAY	CAPACITOR		
				
410029000 ALL MODELS	410126000 ALL MODELS	1432-0002-003 ALL MODELS		

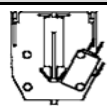
MEDH SERIES

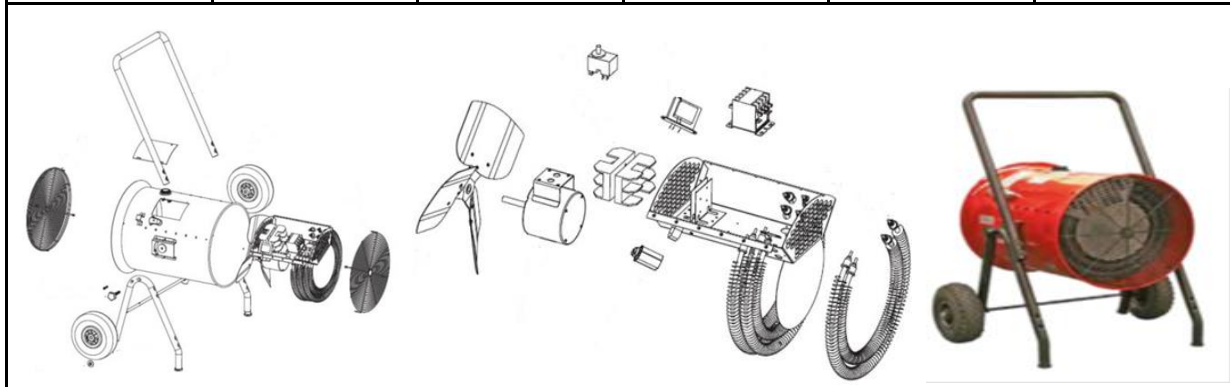
ELEMENT SMALL	ELEMENT LARGE	MOTOR	CONTACTOR		TRANSFORMER
					
1802-11001-000 DH1583A DH1583B DH1583C	1802-11001-001 DH1583A DH1583B DH1583C	3900-11002-000 DH1021A DH1021CKA DH1021CKB DH1021CKC	5018-0006-000 DH1543A DH1543B DH1543C DH3043A DH3043B DH3043C	5018-0006-004 DH1021A DH1021CKA DH1021CKB DH1521A DH1521B DH1521C DH1523A DH1523B DH1523C DH1583A DH1583B DH1583C	5814-0003-002 DH1543A DH1543B DH1543C DH3043A DH3043B DH3043C
1802-11001-002 DH1021A DH1021CKA DH1021CKB DH1021CKC DH1521A DH1521B DH1521C DH1523A DH1523B DH1523C DH1543A DH1543B DH1543C DH3043A DH3043B DH3043C	1802-11001-003 DH1021A DH1021CKA DH1021CKB DH1021CKC DH1521A DH1521B DH1521C DH1523A DH1523B DH1523C DH1543A DH1543B DH1543C DH3043A DH3043B DH3043C	DH1521A DH1521B DH1521C DH1523A DH1523B DH1523C DH1583A DH1583B DH1543C	5018-0006-002 DH1021CKC		
FAN BLADE	HI LIMIT	THERMOSTAT	CAPACITOR	GUARD REAR	GUARD FRONT
					
1210-0098-001 ALL MODELS	410029000 ALL MODELS	5813-2059-000 ALL MODELS	1432-0002-003 ALL MODELS	2504-11004-000 ALL MODELS	2504-11005-000 ALL MODELS
HANDLE	CART KNOB	THERMOSTAT KNOB	WHEEL	SHAFT CAP	AXEL SHAFT
					
2710-11001-000 ALL MODELS	3301-11003-000 ALL MODELS	3301-11018-002 ALL MODELS	6406-11001-000 ALL MODELS	1408-11002-000 ALL MODELS	5217-11001-000 ALL MODELS
CORD	FUSE	FUSE BLOCK	FAN RELAY	FAN DELAY	AUXILIARY SWITCH
					
1016-10593-000 DH1021CKA DH1021CKB SCS10063 DH1021CKC	2019-7008-077 DH1521A DH1521B DH1521C	480030007 DH1521A DH1521B DH1521C	5018-0007-000 DH1543A DH1543B DH1543C DH3043A DH3043B DH3043C	1414-2039-000 DH3043C	5216-10564-000 DH1521C DH1543A DH1543B DH1543C DH3043A DH3043B DH3043C



KD/KS			
UNIT SIZE	PART NUMBER		
	208V	240V	277V
ELEMENTS (AFTER 1993) (250 WATTS/FT. - SEE NOTE 1)			
24" CABINET	1802-2016-001	1802-2016-003	1802-2016-003
36" CABINET	1802-2016-009	1802-2016-010	1802-2016-011
48" CABINET	-	1802-2016-024	1802-2016-024
REPAIR PARTS (AFTER 1993)			
DISCRIPTION		PART NUMBER	
SPOT HIGH LIMIT		410027000	
OPT. THERMOSTAT, 1-POLE		410112000	
OPT. THERMOSTAT, 2-POLE		410113000	
OPTIONAL RELAY (PRIOR TO 1993) (SEE NOTE 2)			
IDENTIFICATION NUMBER ON RELAY		PART NUMBER	
134-60103-301 (24V)		5018-2006-000	
134-60203-301 (120V)		5018-2021-001	
134-60303-301 (208V/240V)		5018-2006-002	
134-62303-301 (277V)		5018-2006-003	
NOTE 1: 500W/FT. UNITS REQUIRE 2 ELEMENTS. 750W/FT. UNITS REQUIRE 3 ELEMENTS. 1000W/FT. UNITS REQUIRE 4 ELEMENTS.			
NOTE 2: WITH SUFFIX "R" ADDED TO CATALOG NUMBER.			

QDB SERIES				
				
DISCRIPTION	PART NUMBERS			
	120V	208V	240V	277V
*ELEMENT (100 WATTS/FT)				
38"	1802-2016-014	1802-2016-006	1802-2016-007	1802-2016-015
50"	1802-2016-016	1802-2016-017	1802-2016-018	1802-2016-019
62"	1802-2016-026	1802-2016-027	1802-2016-028	1802-2016-029
*ELEMENT (188 WATTS/FT)				
38"	1802-2016-012	1802-2016-010	1802-2016-011	1802-2016-013
50"	1802-2016-020	1802-2016-024	1802-2016-025	1802-2016-021
62"	1802-2016-030	1802-2016-034	1802-2016-035	1802-2016-031
				
LINEAR LIMIT		TERMINAL BOX COVER	ELEMENT HANGER CLIP	
38"	410122003	310527001	402020000	
50"	410122004			
62"	410122005			









ADB, APH, & ASH SERIES



DISCRPTION	PART NUMBERS					
	120V	208V	240V	277V	347V	600V
*ELEMENT (125 WATTS/FT)						
28" HEATER	1802-2001-085	1802-2001-086	1802-2001-048	1802-2001-049	NA	NA
3'	1802-2001-087	1802-2001-088	1802-2001-054	1802-2001-055	1802-2001-220	NA
4'	1802-2001-089	1802-2001-090	1802-2001-060	1802-2001-061	1802-2001-230	NA
5'	1802-2001-091	1802-2001-092	1802-2001-066	1802-2001-067	1802-2001-240	1802-2001-241
6'	1802-2001-093	1802-2001-094	1802-2001-072	1802-2001-073	1802-2001-250	1802-2001-251
8'	NA	1802-2001-095	1802-2001-077	1802-2001-078	1802-2001-260	1802-2001-261
10'	NA	1802-2001-096	1802-2001-081	1802-2001-082	1802-2001-270	1802-2001-271
*ELEMENT (188 WATTS/FT)						
28" HEATER	1802-2001-005	1802-2001-002	1802-2001-001	1802-2001-000	NA	NA
3'	1802-2001-011	1802-2001-008	1802-2001-007	1802-2001-006	1802-2001-216	NA
4'	1802-2001-017	1802-2001-014	1802-2001-013	1802-2001-012	1802-2001-226	1802-2001-227
5'	1802-2001-023	1802-2001-020	1802-2001-019	1802-2001-018	1802-2001-236	1802-2001-237
6'	1802-2001-029	1802-2001-026	1802-2001-025	1802-2001-024	1802-2001-246	1802-2001-247
8'	NA	1802-2001-032	1802-2001-031	1802-2001-030	1802-2001-256	1802-2001-257
10'	NA	1802-2001-036	1802-2001-035	1802-2001-034	1802-2001-266	1802-2001-267
*ELEMENT (250 WATTS/FT)						
28" HEATER	1802-2001-004	1802-2001-003	1802-2001-002	1802-2001-001	1802-2001-202	NA
3'	1802-2001-010	1802-2001-009	1802-2001-008	1802-2001-007	1802-2001-214	NA
4'	1802-2001-016	1802-2001-015	1802-2001-014	1802-2001-013	1802-2001-224	1802-2001-225
5'	1802-2001-022	1802-2001-021	1802-2001-020	1802-2001-019	1802-2001-234	1802-2001-235
6'	1802-2001-028	1802-2001-027	1802-2001-026	1802-2001-025	1802-2001-244	1802-2001-245
8'	NA	1802-2001-033	1802-2001-032	1802-2001-031	1802-2001-254	1802-2001-255
10'	NA	1802-2001-037	1802-2001-036	1802-2001-035	1802-2001-264	1802-2001-265

* 1, 2 OR 3 ELEMENTS MAY BE REQUIRED. VOLTAGE AND WATTAGE ARE STAMPED ON END OF ELEMENTS. DIVIDE THE WATTAGE BY THE HEATER LENGTH (FEET) TO DETERMINE WATTS/FOOT OF ELEMENT. THEN USE THIS DATA TO DETERMINE PART NUMBER OF HEATING ELEMENT.



DISCRPTION	PART NUMBERS					
	120V	208V	240V	277V	347V	600V
LINEAR LIMIT						
28" HEATER	4520-0007-007	4520-0007-007	4520-0007-007	4520-0007-007	4520-0007-007	4520-0007-007
3'	4520-0007-008	4520-0007-008	4520-0007-008	4520-0007-008	4520-0007-008	4520-0007-008
4'	4520-0007-009	4520-0007-009	4520-0007-009	4520-0007-009	4520-0007-009	4520-0007-009
5'	4520-0007-010	4520-0007-010	4520-0007-010	4520-0007-010	4520-0007-010	4520-0007-010
6'	4520-0007-011	4520-0007-011	4520-0007-011	4520-0007-011	4520-0007-011	4520-0007-011
8'	NA	4520-0007-012	4520-0007-012	4520-0007-012	4520-0007-012	4520-0007-012
10'	NA	4520-0007-013	4520-0007-013	4520-0007-013	4520-0007-013	4520-0007-013
DISCONNECT SW.	THERMOSTAT	TRANSFORMER RELAY		24V TRANSFORMER		
						
410170001	2-STAGE 5813-0023-000 SINGLE POLE 5813-0024-000	120V 5018-11003-000 208/240V 5018-11003-001	277V 5018-11003-002 347V 5018-11003-003	208/240V PRIMARY 490026001 277V PRIMARY 490026002		
CIRCUIT BREAKER	POWER RELAY					
						
2-POLE, 30A 1226-7009-013 2-POLE, 60A 1226-7009-010 3-POLE, 30A 1226-7009-005 3-POLE, 60A 1226-7009-002	24V 410171001 120V 410171002 208/240V 410171003	277V 410171003				

ARL SERIES (OBS)

ELEMENT

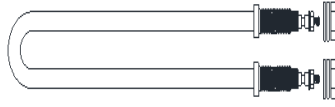
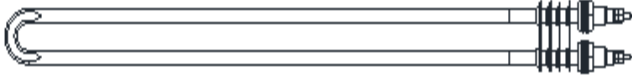

1802-7076-001

L1511B

1802-7076-008

L4521B

HE45240

L4521

1802-7076-003

L2021B

1802-7076-010

L4541B

HE45480

L4541

1802-7076-005

L2041B

1802-7076-011

L4561B

HE20240

L6023

1802-7076-006

L2061B

1802-7076-009

L4571B

HE20480

L6043

1802-7076-004

L2071B

1802-7076-007

L4581B

HE45480

L13543

1802-7076-002

L2081B

RELECTOR

891755004

L1511B

891755002

L4581B

L4541B

L4521B



1.5KW Portable



4.5KW Portable

CRN SERIES (OBS)

ELEMENT





1802-2115-001 N1011A	1802-2115-013 N2001A	1802-7077-001 N1011B	1802-7077-009 N2001B
1802-2115-004 N1021A	1802-2115-015 N2021A	1802-7077-003 N1021B	1802-7077-010 N2021B
1802-2115-006 N1031A	1802-2115-017 N2031A	1802-7077-002 N1081B	1802-7077-012 N2031B
1802-2115-005 N1071A	1802-2115-016 N2071A	1802-7077-004 N1511B	1802-7077-011 N2071B
1802-2115-008 N1501A	1802-2115-018 N2501A	1802-7077-006 N1521B	1802-7077-013 N2501B
1802-2115-007 N1511A	1802-2115-020 N2521A	1802-7077-008 N1531B	1802-7077-014 N2521B
1802-2115-010 N1521A	1802-2115-022 N2531A	1802-7077-007 N1571B	1802-7077-016 N2531B
1802-2115-012 N1531A	1802-2115-021 N2571A	1802-7077-005 N1581B	1802-7077-015 N2571B
1802-2115-011 N1571A			





FRR & CMRR SERIES (OBS)

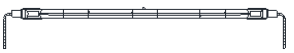

ELEMENT

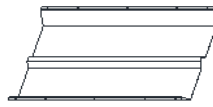
			
1802-0070-509 RR22012A	1802-2113-501 RR41512A	1802-2119-500 RR10512A	1802-2151-001 RR26164
1802-0070-550 RR35724A	1802-2113-516 RR53024A	RR11012A	1802-2151-000 RR26168

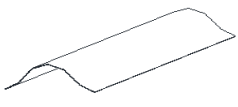
REFLECTOR



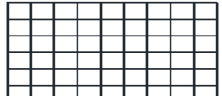

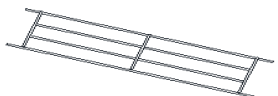
			
5007-2013-000 RR41512A	5007-2020-000 RR22012A	5007-2021-000 RR10512A	5007-2027-000 RR26164
5007-2013-001 RR53024A	5007-2020-001 RR35724A	RR11012A	RR26168

WIRE GUARD

			
2504-2014-000 RR35724A	2504-2015-000 RR22012A	2504-2016-000 RR41512A	2504-2017-000 RR10512A
		2504-2016-001 RR53024A	RR11012A
		2504-2016-002 RR26164	
		RR26168	

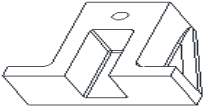
CERAMIC BLOCK

SWITCH





			
1224-0049-000 RR22012A	1224-2006-000 RR10512A	410024000 RR11012A	5216-11009-000 RR22012A
RR26164	RR11012A		RR35724A
RR26168			
RR35724A			

ELEMENT BUSHING

CORD

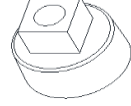
CHAIN 4'

"S" HOOKS

			
1213-0070-000 RR22012A	1420-2016-000 RR10512A	1404-2000-001 RR10512A	2706-2000-000 RR10512A
RR26164	RR41512A	RR11012A	RR11012A
RR26168	1420-2016-008 RR11012A	RR22012A	RR22012A
RR35724A	1420-2016-002 RR22012A	RR35724A	RR35724A
	1420-2031-000 RR35724A	RR41512A	RR41512A
	1420-2016-001 RR53024A	RR53024A	RR53024A

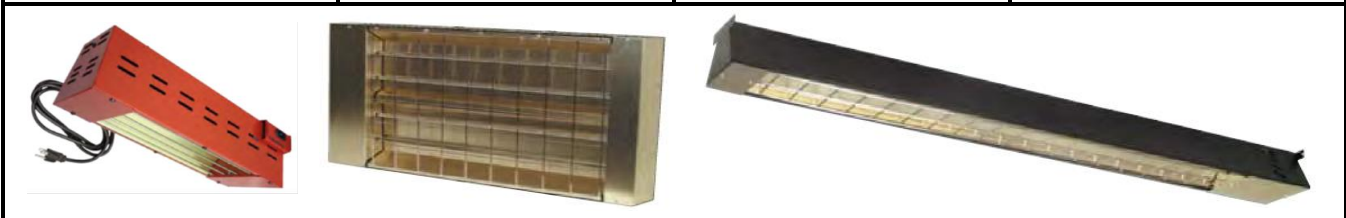

RDO SERIES				
KEY NUMBER	DESCRIPTION	PART NUMBER		
		RDO26	RDO35	RDO48
1	REFLECTOR: 60/90 SYM	-	-	-
	30 DEGREES SYM	-	-	-
	60/90 ASYM	-	-	-
	30 DEGREES ASYM	-	-	-
2	INSULATOR	-	-	-
3	TERMINAL BLOCK (4 REQ)	1224-0049-000	1224-0049-000	1224-0049-000
4	ELEMENT TERM. BUSH. (4 REQ)	1213-0070-000	1213-0070-000	1213-0070-000

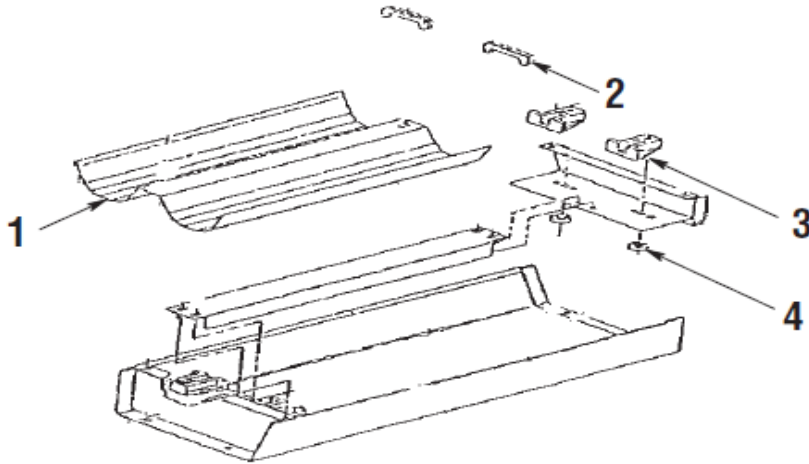

QRH SERIES		
ELEMENTS	RH16-91S-208	2QL16208
	RH16-91S-240	2QL16240
	RH16-91S-277	2QL16277

INDUSTRIAL CEILING FANS (FANS ARE PHASED OUT SOME PARTS MAY NOT BE AVAILABLE)

BLADE (SET)

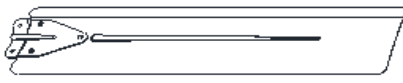

9B3620-1 36201	9B4820-3 48203	9B5600-1 56001	9B6000-1 60001	9B5630-1R 56301RDP
9B4820-1 48201 48207	9B5600-1LC 56001LC 56101	56002 56003 56007	9B6001-1 60011	
9B4820-1B 48201B	56111	9B5601-1 56011	9B6011-1 60101 60111	
		9B5600-1B 56001B	9B5620-1 56201	

DOWNROD 24"

DOWNROD 8"

MOTOR

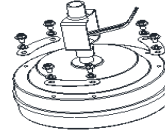

9D24BW 36201 48201 56001LC 56001 56002 56003 56007 56301RDP 48203 48207 60001 56201	9D24BBLK 48201B 56001B 9D24BB 56011 60011 9D12TW 56101 56111 60101 60111	9D08 36201 48201 56001LC 56003 48203 9D08BBLK 48201B	9M3620-1-A 36201 9M4820-1-A 48201 9M4820-1B-A 48201B 9M4820-3-A 48203 9M5600-7-A 48207 6011-1U 60111	9M5600-1LC-A 56001LC 9M5600-1-A 56001 9M5600-1B-A 56001B 9M5600-4-A 56002 9M5600-3-A 56003 9M5600-7-A 56007	9M5601-1-A 56011 5611-1U 56101 56111 9M5630-1R-A 56301RDP 9M6000-1-A 60001 9M6001-1-A 60011 9M5620-1-A 56201
--	---	---	---	--	--

RUBBER ROLLER

J HOOK KIT

BLADE SCREWS (6 REQ)

BLADE PADS (3 REQ)

REVERSIBLE TOGGLE

REVERSING SW. PLATE

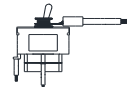
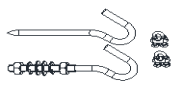
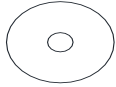

9F2900-04A ALL MODELS	9F2900-01 ALL MODELS	9F2900-20A ALL MODELS	9F2900-19A ALL MODELS	9F2GX54-73 56301RDP	9FP005 56301RDP
---------------------------------	--------------------------------	---------------------------------	---------------------------------	-------------------------------	---------------------------

CANOPY UPPER

CANOPY LOWER



9F2900-07A 36201 48201 56001LC 56001 56002 56003 56007 56301RDP 48203 48207 60001 56201	9F2900-07AB 48201B 56001B 9FP029 56011 60011 3100039A 56101 56111 60101 60111	9F2900-08A 36201 48201 56001LC 56001 56002 56003 56007	60001 60101 60111 56301RDP 48203 48207 56101 56111	9F2900-08AB 48201B 56001B 9FP030 56011 60011
--	--	--	---	---

3-SPEED PULL CHAIN SW.

PULL CHAIN STRING

OUTDOOR KIT

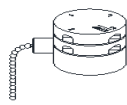

PICTURE NOT AVAILABLE

9F2900-26 48203 56003	3378 48203 56003	99992 56101 60101
------------------------------------	-------------------------------	--------------------------------

