

This catalog contains part numbers for the most common replacement parts for Berko heaters shown in the Table of Contents. Additional parts for these heaters may be available - consult factory for availability. Parts for Berko heaters not listed in the Table of Contents may be available - consult factory for availability.

TABLE OF CONTENTS

BASEBOARD	UNIT HEATERS	RADIANT
(2500 Series & BKOC)..... 2	CUH900 19	XRM 38
Baseboard Accessories 4	PHFP25 21	VRP & VRS 39
HBB 5	HUH 22	JRK 40
WALL HEATERS	BDH MODEL D..... 23	RCC 41
SSARWH 6	BSDH 24	PORTABLE
SSHOWH 7	BPH 25	QPH4A 29
HT 8	HUHA AFC..... 26	FBE 42
FRC (WH-FC) 9	HUH524TA & HUH724ST 28	LFP 42
FRA (WHB3000) 10	PH5 29	FHP 43
SRA (WHB1000) 11	BWD 30	INDUSTRIAL PRODUCTS
SRA ARCHITECTURAL SERIES 12	CONNECTORS	DOE CEILING FANS 44
VFK 13	UCJ 31	
GFR 14	ASL 32	
SED 15	BDBSL 33	
COS-E 16	ICST 34	
SPECIALTY HEATERS	CSL 35	
QTS 17	CPL 35	
FDI 17	ASLC 36	
WHT 17	THX 37	
CEILING HEATERS		
QCH 18		
QFF 18		
FFCH 18		

OBsolete PRODUCTS

SOME PARTS MAY NO LONGER BE AVAILABLE FOR OBSOLETE PRODUCTS

WALL HEATERS	CEILING HEATERS	RADIANT
MCSSAR 45	SCH 51	WRL 65
QFG 46	UNIT HEATERS	YRN 66
MFQ 47	TBX 58	FFR 67
ECP 48	CUH 59	PMRR 67
MFA 49	VUH 59	RH 68
CRA 50	VUH-A 59	INDUSTRIAL PRODUCTS
BVP 51	HUHAA 60	COMMERCIAL CEILING FANS 69
A2500 51	BDH 62	
1235 & 2435 52	CONNECTORS	
B2400 51	CC & DCC 63	
SR 53	DB 63	
SRA 54	SPECIALTY HEATERS	
FR 55	CFWF 17	
FRA 56	BASEBOARD	
FRC 57	OBD 5	
	PORTABLE	
	WPC 64	

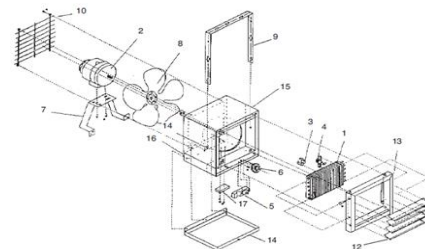

FOR SERVICE PARTS CONTACT CARROLL PARTS 800-654-3545

C2500 & 2500 SERIES

ELEMENTS



1802-11021-008	1802-11021-009	1802-11021-010	1802-11021-011	1802-2044-014	1802-2044-015
2573WCA	2543WCA	2503WCA	2513WCA	2574WCA	2544WCA
2573NWCA	2543NWCA	2503NWCA	2513NWCA	2574NWCA	2544NWCA
C2573WCA	C2543WCA	C2503WCA	C2513WCA	C2574WCA	C2544WCA
C2573NWCA	C2543NWCA	C2503NWCA	C2513NWCA	C2574NWCA	C2544NWCA
1802-2044-026	1802-2094-017	1802-2044-028	1802-2094-015	1802-2044-016	1802-2044-017
2576WCA	2546WCSA	2506WCA	2516WCSA	2504WCA	2514WCA
2576NWCA	2546NWCSA	2506NWCA	2516NWCSA	2504NWCA	2514NWCA
C2576WCA	C2546WCSA	C2506WCA	C2516WCSA	C2504WCA	C2514WCA
C2576NWCA	C2546NWCSA	C2506NWCA	C2516NWCSA	C2504NWCA	C2514NWCA
1802-2044-020	1802-2044-021	1802-2044-022	1802-2044-023	1802-2094-000	1802-2094-001
2575WCA	2545WCA	2505WCA	2515WCA	2508WCSA	2548WCSA
2575NWCA	2545NWCA	2505NWCA	2515NWCA	2508NWCSA	2548NWCSA
C2575WCA	C2545WCA	C2505WCA	C2515WCA	C2508WCSA	C2548WCSA
C2575NWCA	C2545NWCA	C2505NWCA	C2515NWCA	C2508NWCSA	C2548NWCSA
1802-11021-000	1802-11021-001	1802-11021-002	1802-11021-003	1802-2094-002	1802-2094-003
2572WCA	2542WCA	2502WCA	2512WCA	2578WCSA	25008WCSA
2572NWCA	2542NWCA	2502NWCA	2512NWCA	2578NWCSA	25008NWCSA
C2572WCA	C2542WCA	C2502WCA	C2512WCA	C2578WCSA	C25008WCSA
C2572NWCA	C2542NWCA	C2502NWCA	C2512NWCA	C2578NWCSA	C25008NWCSA
1802-11021-004	1802-11021-005	1802-11021-006	1802-11021-007	1802-2094-004	1802-2094-005
25726WCA	25426WCA	25026WCA	25126WCA	25408WCSA	25708WCSA
25726NWCA	25426NWCA	25026NWCA	25126NWCA	25408NWCSA	25708NWCSA
C25726WCA	C25426WCA	C25026WCA	C25126WCA	C25408WCSA	C25708WCSA
C25726NWCA	C25426NWCA	C25026NWCA	C25126NWCA	C25408NWCSA	C25708NWCSA

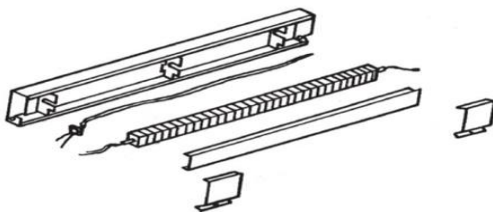

C2500 & 2500 SERIES CONTINUED

THERMAL CUTOUT



4520-2018-000		4520-2018-001		4520-2018-002		4520-2018-003		4520-2018-004	
2512NWC	2512WC	25126NWC	25126WC	2513NWC	2513WC	2514NWC	2514WC	2515NWC	2515WC
2512NWC	2512WCA	25126NWC	25126WCA	2513NWC	2513WCA	2514NWC	2514WCA	2515NWC	2515WCA
2502NWC	2502WC	25026NWC	25026WC	2503NWC	2503WC	2504NWC	2504WC	2505NWC	2505WC
2502NWC	2502WCA	25026NWC	25026WCA	2503NWC	2503WCA	2504NWC	2504WCA	2505NWC	2505WCA
2542NWC	2542WC	25426NWC	25426WC	2543NWC	2543WC	2544NWC	2544WC	2545NWC	2545WC
2542NWC	2542WCA	25426NWC	25426WCA	2543NWC	2543WCA	2544NWC	2544WCA	2545NWC	2545WCA
2572NWC	2572WC	25726NWC	25726WC	2573NWC	2573WC	2574NWC	2574WC	2575NWC	2575WC
2572NWC	2572WCA	25726NWC	25726WCA	2573NWC	2573WCA	2574NWC	2574WCA	2575NWC	2575WCA
C2512NWC	C2512WC	C25126NWC	C25126WC	C2513NWC	C2513WC	C2514NWC	C2514WC	C2515NWC	C2515WC
C2502NWC	C2512WCA	C25026NWC	C25126WCA	C2503NWC	C2513WCA	C2504NWC	C2514WCA	C2505NWC	C2515WCA
C2542NWC	C2502WC	C25426NWC	C25026WC	C2543NWC	C2503WC	C2544NWC	C2504WC	C2545NWC	C2505WC
C2572NWC	C2502WCA	C25726NWC	C25026WCA	C2573NWC	C2503WCA	C2574NWC	C2504WCA	C2575NWC	C2505WCA
	C2542WC		C25426WC		C2543WC		C2544WC		C2545WC
	C2542WCA		C25426WCA		C2543WCA		C2544WCA		C2545WCA
	C2572WC		C25726WC		C2573WC		C2574WC		C2575WC
	C2572WCA		C25726WCA		C2573WCA		C2574WCA		C2575WCA
4520-2018-005		4520-2018-006		4520-2019-000		4520-2019-001		4520-2019-002	
2516NWC	2516WC	2508NWC	2508WC	2512HNWC	2512HWC	25126HNWC	25126HWC	2513HNWC	2513HWC
2516NWC	2516WCA	2508NWC	2508WCA	2512HNWC	2512HWCA	25126HNWC	25126HWCA	2513HNWC	2513HWCA
2506NWC	2506WC	25008NWC	25008WC	2502HNWC	2502HWC	25026HNWC	25026HWC	2503HNWC	2503HWC
2506NWC	2506WCA	25008NWC	25008WCA	2502HNWC	2502HWCA	25026HNWC	25026HWCA	2503HNWC	2503HWCA
2546NWC	2546WC	2548NWC	2548WC	2542HNWC	2542HWC	25426HNWC	25426HWC	2543HNWC	2543HWC
2546NWC	2546WCA	2548NWC	2548WCA	2542HNWC	2542HWCA	25426HNWC	25426HWCA	2543HNWC	2543HWCA
2546NWC	2546WCS	2548NWC	2548WCS	2572HNWC	2572HWC	25726HNWC	25726HWC	2573HNWC	2573HWC
2546NWC	2546WCSA	2548NWC	2548WCSA	2572HNWC	2572HWCA	25726HNWC	25726HWCA	2573HNWC	2573HWCA
2576NWC	2576WC	25408NWC	25408WC						
2576NWC	2576WCA	25408NWC	25408WCA						
2576NWC	2576WCS	25408NWC	25408WCS						
2576NWC	2576WCSA	25408NWC	25408WCSA						
C2516NWC	C2516WC	25408NWC	25408WC						
C2506NWC	C2516WCA	25408NWC	25408WCA						
C2546NWC	C2506WC	2578NWC	2578WC						
C2576NWC	C2506WCA	2578NWC	2578WCA						
	C2546WC	25708NWC	25708WC						
	C2546WCA	25708NWC	25708WCA						
	C2576WC	C2508NWC	C2508WC						
	C2576WCA	C25008NWC	C2508WCA						
		C2548NWC	C25008WC						
		C2548NWC	C25008WCA						
		C2578NWC	C2548WC						
		C2578NWC	C2548WCA						
			C25408WC						
			C25408WCA						
			C2578WC						
			C2578WCA						
			C25708WC						
			C25708WCA						
4520-2019-005		4520-2019-006		4520-2019-003		4520-2019-004			
2516HNWC	2516HWC	2508HNWC	2508HWC	2514HNWC	2514HWC	2515HNWC	2515HWC		
2516HNWC	2516HWCA	2508HNWC	2508HWCA	2514HNWC	2514HWCA	2515HNWC	2515HWCA		
2506HNWC	2506HWC	25008HNWC	25008HWC	2504HNWC	2504HWC	2505HNWC	2505HWC		
2506HNWC	2506HWCA	25008HNWC	25008HWCA	2504HNWC	2504HWCA	2505HNWC	2505HWCA		
2546HNWC	2546HWC	2548HNWC	2548HWC	2544HNWC	2544HWC	2545HNWC	2545HWC		
2546HNWC	2546HWCA	2548HNWC	2548HWCA	2544HNWC	2544HWCA	2545HNWC	2545HWCA		
2576HNWC	2576HWC	25408HNWC	25408HWC	2574HNWC	2574HWC	2575HNWC	2575HWC		
2576HNWC	2576HWCA	25408HNWC	25408HWCA	2574HNWC	2574HWCA	2575HNWC	2575HWCA		
	C2516HWC	2578HNWC	2578HWC						
	C2516HWCA	2578HNWC	2578HWCA						
	C2506HWC	25708HNWC	25708HWC						
	C2506HWCA	25708HNWC	25708HWCA						
	C2546HWC		C2508HWC						
	C2546HWCA		C2508HWCA						
	C2576HWC		C25008HWC						
	C2576HWCA		C25008HWCA						
			C2548HWC						
			C2548HWCA						
			C25408HWC						
			C25408HWCA						
			C2578HWC						
			C2578HWCA						
			C25708HWC						
			C25708HWCA						

C2500 & 2500 SERIES CONTINUED

FACE PLATE



COLOR	FEET	GA.	PART NUMBER	COLOR	FEET	GA.	PART NUMBER
NAVAJO	2.5	18	1402-2122-040	NORTHERN WHITE	2.5	18	1402-2122-061
NAVAJO	3	18	1402-2122-041	NORTHERN WHITE	3	18	1402-2122-062
NAVAJO	4	18	1402-2122-042	NORTHERN WHITE	4	18	1402-2122-063
NAVAJO	5	18	1402-2122-043	NORTHERN WHITE	5	18	1402-2122-064
NAVAJO	6	18	1402-2122-044	NORTHERN WHITE	6	18	1402-2122-065
NAVAJO	8	18	1402-2122-045	NORTHERN WHITE	8	18	1402-2122-066
NAVAJO	2	22	1402-2122-635	NORTHERN WHITE	2	22	1402-2122-623
NAVAJO	2.5	22	1402-2122-628	NORTHERN WHITE	2.5	22	1402-2122-616
NAVAJO	3	22	1402-2122-629	NORTHERN WHITE	3	22	1402-2122-617
NAVAJO	4	22	1402-2122-630	NORTHERN WHITE	4	22	1402-2122-618
NAVAJO	5	22	1402-2122-631	NORTHERN WHITE	5	22	1402-2122-619
NAVAJO	6	22	1402-2122-632	NORTHERN WHITE	6	22	1402-2122-620
NAVAJO	8	22	1402-2122-633	NORTHERN WHITE	8	22	1402-2122-621

NOTE: 18GA IS FOR COMERCIAL MODELS

CONTROL BOX COVER











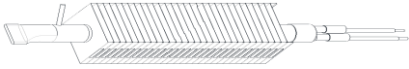

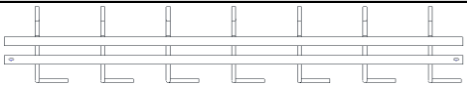
COLOR	GA.	PART NUMBER	COLOR	GA.	PART NUMBER
NAVAJO	24	1402-2261-601	NORTHERN WHITE	24	1402-2261-600
NAVAJO	20	1402-2261-603	NORTHERN WHITE	20	1402-2261-604







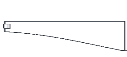

NOTE: 20 GA IS FOR COMERCIAL MODELS

ACCESSORIES

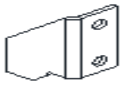
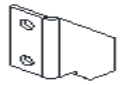

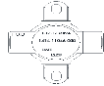
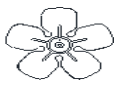
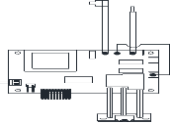

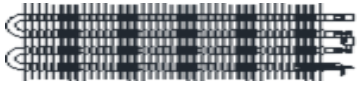
MODEL	KNOBS	THERMOSTATS
T1	3301-2011-000	5813-2014-000
T2	3301-2011-000	5813-2015-000
T1A	3301-2014-006	410127001
T2A	3301-2020-004	410128001
T4		410129001
T4A	3301-2014-006	410129001
T5A	3301-2020-004	410130001
TA1AW	42521-032-10	5813-2009-000
TA2AW	42521-032-08	5813-2010-000
TA1ANW	42521-032-11	5813-2009-000
TA2ANW	42521-032-09	5813-2010-000
TA1AWCA	42521-032-10	5813-2009-000
TA2AWCA	42521-032-08	5813-2010-000
TA1ANWCA	42521-032-11	5813-2009-000
TA2ANWCA	42521-032-09	5813-2010-000

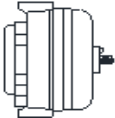
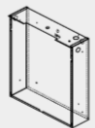
HBB SERIES BASEBOARD											
ELEMENT						LIMIT					
											
1802-2068-000	1802-2068-001	1802-2068-002	1802-2068-003	1802-2068-004	1802-2068-016	410122002	410122003	410122004	410122005	410122006	410122008
500D	7500D	1000D	1250D	1500D	2004D	500D	7500D	1000D	1250D	1500D	2004D
500DA	7500DA	1000DA	1250DA	1500DA	2004DA	500DA	7500DA	1000DA	1250DA	1500DA	2004DA
500DB	7500DB	1000DB	1250DB	1500DB	2004DB	500DB	7500DB	1000DB	1250DB	1500DB	2004DB
1802-2068-011	1802-2068-012	1802-2068-013	1802-2068-014	1802-2068-015	1802-2067-010	504D	7504D	1004D	1254D	1504D	2007D
504D	7504D	1004D	1254D	1504D	2008D	504DA	7504DA	1004DA	1254DA	1504DA	2008D
504DA	7504DA	1004DA	1254DA	1504DA	2008DA	504DB	7504DB	1004DB	1254DB	1504DB	2008DA
504DB	7504DB	1004DB	1254DB	1504DB		508D	7507D	1007D	1257D	1507D	2008DB
1802-2068-005	1802-2068-006	1802-2068-007	1802-2068-008	1802-2068-009		508DA	7508D	1008D	1258D	1508D	
508D	7508D	1008D	1258D	1508D		508DA	7508DA	1008DA	1258DA	1508DA	
508DA	7508DA	1008DA	1258DA	1508DA		508DB	7508DB	1008DB	1258DB	1508DB	
508DB	7508DB	1008DB	1258DB	1508DB							
FRONT COVER						GRILLE					
											
1402-2066-000	1402-2066-001	1402-2066-002	1402-2066-003	1402-2066-004	1402-2066-005	2501-2012-012	2501-2012-013	2501-2012-014	2501-2012-015	2501-2012-010	2501-2012-011
500D	7500D	1000D	1250D	1500D	2004D	500D	7500D	1000D	1250D	1500D	2004D
500DA	7500DA	1000DA	1250DA	1500DA	2004DA	500DA	7500DA	1000DA	1250DA	1500DA	2004DA
500DB	7500DB	1000DB	1250DB	1500DB	2004DB	500DB	7500DB	1000DB	1250DB	1500DB	2004DB
504D	7504D	1004D	1254D	1504D	2007D	504D	7504D	1004D	1254D	1504D	2008D
504DA	7504DA	1004DA	1254DA	1504DA	2008D	504DA	7504DA	1004DA	1254DA	1504DA	2008DA
504DB	7504DB	1004DB	1254DB	1504DB	2008DA	504DB	7504DB	1004DB	1254DB	1504DB	2008DA
508D	7507D	1007D	1257D	1507D	2008DB	508D	7507D	1007D	1257D	1507D	2008DB
508DA	7508D	1008D	1258D	1508D		508DA	7508D	1008D	1258D	1508D	
508DB	7508DA	1008DA	1258DA	1508DA		508DB	7508DA	1008DA	1258DA	1508DB	
508DB	7508DB	1008DB	1258DB	1508DB							
JUNCTION BOX COVER ALL MODELS 1800-2022-000											
											
OBD SERIES BASEBOARD (OBSOLETE)											
ELEMENT						LIMIT					
											
1802-2056-007	1802-2056-011	1802-2063-017	1802-2063-023	1802-2094-015	1802-2063-033	4520-2018-001	4520-2018-002	4520-2018-003	4520-2018-004	4520-2018-005	4520-2018-006
D500	D750	D1000	D1250	D1500	D2004	D500	D750	D1000	D1250	D1500	D2004
D500A	D750A	D1000A	D1250A	D1500A	D2004A	D500A	D750A	D1000A	D1250A	D1500A	D2004A
1802-2056-005	1802-2056-009	1802-2063-015	1802-2063-021	1802-2063-027	1802-2063-032	D504	D754	D1004	D1254	D1504	D2007
D504	D754	D1004	D1254	D1504	D2007	D504A	D754A	D1004A	D1254A	D1504A	D2007A
D504A	D754A	D1004A	D1254A	D1504A	D2007A	D507	D757	D1007	D1256	D1507	D2008
1802-2056-004	1802-2056-008	1802-2063-014	1802-2063-047	1802-2063-026	1802-2063-034	D507A	D757A	D1007A	D1256A	D1507A	D2008A
D507	D757	D1007	D1256	D1507	D2008	D507A	D757A	D1007A	D1256A	D1507A	D2008A
D507A	D757A	D1007A	D1256A	D1507A	D2008A	D508	D758	D1008	D1257	D1508	
1802-2056-006	1802-2056-010	1802-2063-016	1802-2063-020	1802-2063-028		D508A	D758A	D1008A	D1257A	D1508A	
D508	D758	D1008	D1257	D1508		D508A	D758A	D1008A	D1257A	D1508A	
D508A	D758A	D1008A	D1257A	D1508A							
			1802-2063-022								
			D1258								
			D1258A								
FRONT COVER						GRILLE					
											
1402-2066-010	1402-2066-011	1402-2066-012	1402-2066-013	1402-2066-014	1402-2066-015	2501-2012-012	2501-2012-013	2501-2012-014	2501-2012-015	2501-2012-010	2501-2012-011
D500	D750	D1000	D1250	D1500	D2004	D500	D750	D1000	D1250	D1500	D2004
D500A	D750A	D1000A	D1250A	D1500A	D2004A	D500A	D750A	D1000A	D1250A	D1500A	D2004A
D504	D754	D1004	D1254	D1504	D2007	D504	D754	D1004	D1254	D1504	D2007
D504A	D754A	D1004A	D1254A	D1504A	D2007A	D504A	D754A	D1004A	D1254A	D1504A	D2007A
D507	D757	D1007	D1256	D1507	D2008	D507A	D757A	D1007A	D1256A	D1507A	D2008A
D507A	D757A	D1007A	D1256A	D1507A	D2008A	D508	D758	D1008	D1257	D1508	
D508	D758	D1008	D1257	D1508		D508A	D758A	D1008A	D1257A	D1508A	
D508A	D758A	D1008A	D1257A	D1508A							
			D1258								
			D1258A								
JUNCTION BOX COVER ALL MODELS 1800-2022-000											
											
SEE ACCESSORIES ON 2500 SERIES PAGE FOR T1 & T2 THERMOSTAT PARTS											

ARWH SERIES

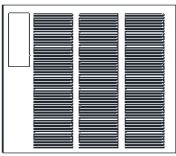
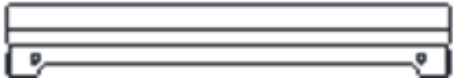

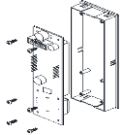
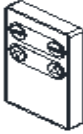
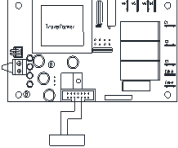
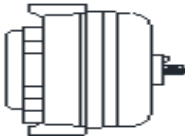

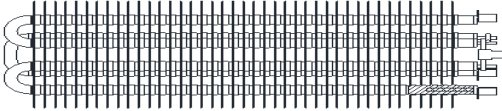
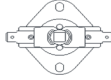
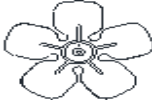
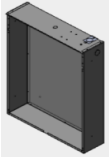

RIGHT BEZEL	LEFT BEZEL	DISPLAY ASSM.	BOTTOM BRACKET LT.	BOTTOM BRACKET RT.	REMOTE	EOL LIMIT	FAN BLADE
							
1219-11009-001 ALL MODELS	1219-11009-000 ALL MODELS	1016-11188-000 ALL MODELS	1215-11070-000 ALL MODELS	1215-11070-001 ALL MODELS	1414-11037-001 ALL MODELS	1414-11046-000 ALL MODELS	490030103 ALL MODELS
PWR CONTROL BOARD			DISCONNECT SWITCH	ELEMENT			
							
1414-11033-002 ARWH1802 ARWH1802AL ARWH1802BZ ARWH1802W	1414-11033-001 ARWH4807 ARWH4807AL ARWH4807BZ ARWH4807W	1414-11033-000 ARWH4808 ARWH4804 ARWH4808AL ARWH4804AL ARWH4808BZ ARWH4804BZ ARWH4808W ARWH4804W	410170001 ARWH1802 ARWH1802AL ARWH1802BZ ARWH1802W ARWH4804 ARWH4804AL ARWH4804BZ ARWH4804W ARWH4807 ARWH4807AL ARWH4807BZ ARWH4807W	302012828 ARWH1802 ARWH1802AL ARWH1802BZ ARWH1802W	1802-2075-801 ARWH4808 ARWH4808AL ARWH4808BZ ARWH4808W	302012810 ARWH4804 ARWH4804AL ARWH4804BZ ARWH4804W	302012811 ARWH4807 ARWH4807AL ARWH4807BZ ARWH4807W
MOTOR			BACK BOX	PARTS KIT			
							
3900-11026-002 ARWH1802 ARWH1802AL ARWH1802BZ ARWH1802W	3900-11026-001 ARWH4807 ARWH4807AL ARWH4807BZ ARWH4807W	3900-11026-000 ARWH4808 ARWH4804 ARWH4808AL ARWH4804AL ARWH4808BZ ARWH4804BZ ARWH4808W ARWH4804W	1203-11011-000 ALL MODELS	1205-11023-000 ALL MODELS			



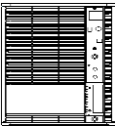

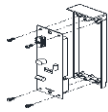
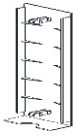

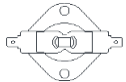
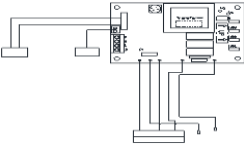
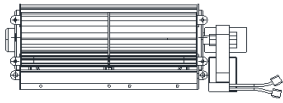
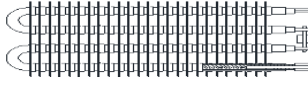







SSHO SERIES

GRILLE			GRILLE TABS (2 REQ)			LIGHT
						
2501-11022-000 HOSS4004 HOSS4007 HOSS4008	2501-11022-001 HOSS4004SB HOSS4007SB HOSS4008SB	2501-11022-002 HOSS4004NV HOSS4007NV HOSS408NV	1402-2120-002 HOSS4004 HOSS4007 HOSS4008	1402-2120-001 HOSS4004SB HOSS4007SB HOSS4008SB	1402-2120-000 HOSS4004NV HOSS4007NV HOSS408NV	3510-2017-005 ALL MODELS
DISPLAY ASSM.	REMOTE	CTRL PWR BOARD		MOTOR		DISCONNECT SWITCH
						
1016-11199-000 ALL MODELS	1414-11037-001 ALL MODELS	1414-11043-000 HOSS4004 HOSS4004NV HOSS4004SB HOSS4008 HOSS408NV HOSS4008SB	1414-11043-001 HOSS4007 HOSS4007NV HOSS4007SB	3900-2002-522 HOSS4004 HOSS4004NV HOSS4004SB HOSS4008 HOSS408NV HOSS4008SB	3900-2002-523 HOSS4007 HOSS4007NV HOSS4007SB	410170001 ALL MODELS
ELEMENT			MANUAL LIMIT	FAN BLADE	BACK BOX	PARTS KIT
						
1802-11005-000 HOSS4008 HOSS408NV HOSS4008SB	1802-11005-001 HOSS4004 HOSS4004NV HOSS4004SB	1802-11005-002 HOSS4007 HOSS4007NV HOSS4007SB	4520-2027-000 ALL MODELS	490030103 ALL MODELS	1016-11242-000 ALL MODELS	1205-2020-002 ALL MODELS



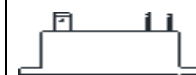







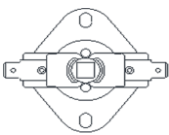

HT SMART SERIES

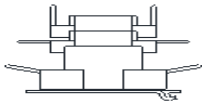

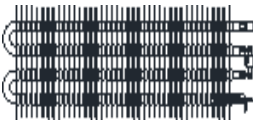

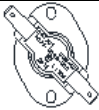

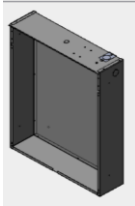



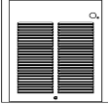

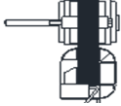
GRILLE PANEL		GRILLE ASSY INSERT		DISPLAY BEZEL	BOTTOM BEZEL	REMOTE	MANUAL LIMIT
							
2501-11003-003 HT1502SS HT2024SS	2501-11003-004 HT1502SSNW HT2024SSNW	1016-11063-000 HT1502SS HT2024SS	1016-11063-001 HT1502SSNW HT2024SSNW	1016-11035-003 HT1502SS HT2024SS HT1502SSNW HT2024SSNW	1219-11004-000 ALL MODELS	1414-11017-001 ALL MODELS	4520-11005-000 ALL MODELS
CNTRL PWR BOARD		BLOWER MOTOR		ELEMENT		LIGHT	
							
1414-11007-002 HT1502SS HT1502SSNW	1414-11007-003 HT2024SS HT2024SSNW	1225-11001-000 HT1502SS HT1502SSNW	1225-11001-001 HT2024SS HT2024SSNW	302023802 HT1502SS HT1502SSNW	302023805 HT2024SS HT2024SSNW	3510-2010-000 HT1502SS HT1502SSNW	3510-2010-001 HT2024SS HT2024SSNW
BACK BOX	PARTS KIT						
1016-11032-000 ALL MODELS	1205-11010-000 ALL MODELS						

WH-FC SERIES (FRC)											
GRILLE			ELEMENTS				DISCONNECT SWITCH				
											
1016-11225-000 WH3150FC WH44083FC WH3180FC WH4503FC WH4303FC WH4504FC WH4306FC WH45043FC WH4307FC WH4506FC WH4404FC WH4507FC WH44043FC WH4508FC WH4407FC WH45083FC WH4408FC		1016-11225-001 WH3150FCNW WH44083FCNW WH3180FCNW WH4503FCNW WH4303FCNW WH4504FCNW WH4306FCNW WH45043FCNW WH4307FCNW WH4506FCNW WH4404FCNW WH4507FCNW WH44043FCNW WH4508FCNW WH4407FCNW WH45083FCNW WH4408FCNW		302012806 WH4307FC WH4307FCNW 302012824 WH4506FC WH4506FCNW 302012808 WH4404FC WH4404FCNW 302012827 WH3150FC WH3150FCNW	302012809 WH4407FC WH4407FCNW 302012829 WH3180FC WH3180FCNW 302012807 WH4408FC WH4408FCNW 302012820 WH4306FC WH4306FCNW	302012810 WH4504FC WH4504FCNW 302012811 WH4507FC WH4507FCNW 302012819 WH4303FC WH4303FCNW 302012823 WH4503FC WH4503FCNW	1802-2075-802 WH44043FC WH44043FCNW WH44083FC WH44083FCNW 1802-2075-803 WH45043FC WH45043FCNW 1802-2075-801 WH4508FC WH4508FCNW WH45083FC WH45083FCNW	410170001 WH3150FC WH4407FC WH3150FCNW WH4407FCNW WH3180FC WH4408FC WH3180FCNW WH4408FCNW WH4307FC WH4504FC WH4307FCNW WH4504FCNW WH4404FC WH4507FC WH4404FCNW WH4507FCNW		5216-2019-000 WH4303FC WH4503FCNW WH4303FCNW WH45043FC WH306FC WH45043FCNW WH4306FCNW WH4506FC WH44043FC WH4506FCNW WH44043FCNW WH4508FC WH44083FC WH4508FCNW WH4503FC WH45083FCNW	
MOTOR			FAN DELAY				RELAY			TRANSFORMER	
											
3900-2010-000 WH4303FC WH4408FCNW WH4303FCNW WH4503FC WH4306FC WH4503FCNW WH4306FCNW WH4504FC WH4404FC WH4504FCNW WH4404FCNW WH4506FC WH4408FC WH4506FCNW		3900-2010-001 WH4507NW WH4307FC WH4407FC WH4407FCNW WH4507FC WH4507FCNW	3900-2010-003 WH3150FC WH3150FCNW WH3180FC WH3180FCNW	3900-2002-518 WH44043FC WH44043FCNW WH44083FC WH44083FCNW WH45043FC WH45043FCNW WH4508FC WH4508FCNW WH45083FC WH45083FCNW	410074000 WH3150FC WH4407FC WH3150FCNW WH4407FCNW WH3180FC WH4408FC WH3180FCNW WH4408FCNW WH4303FC WH4503FC WH4303FCNW WH4503FCNW WH4306FC WH4504FC WH4306FCNW WH4504FCNW WH4307FC WH4506FC WH4307FCNW WH4506FCNW WH4404FC WH4507FC WH4404FCNW WH4507FCNW	4520-2024-000 WH44043FC WH44043FCNW WH44083FC WH44083FCNW WH45043FC WH45043FCNW WH4508FC WH4508FCNW WH45083FC WH45083FCNW	410101002 WH44043FC WH44083FC WH44043FCNW WH44083FCNW WH45043FC WH4508FC WH45043FCNW WH4508FCNW WH45083FC WH45083FCNW		490015017 WH4303FC WH4303FCNW WH4503FC WH4503FCNW	490015013 WH4306FC WH4306FCNW WH4506FC WH4506FCNW	
THERMOSTAT	MANUAL LIMIT	FAN BLADE	RELAY FOR MODELS OLDER THAN MARCH 2020				AUTO LIMIT	BACK BOX			
											
410168002 1 PHASE MODELS	4520-2027-000 ALL MODELS	490030103 ALL MODELS	5018-2017-000 WH44043FC WH44043FCNW WH45043FC WH45043FCNW 5018-2017-004 WH44083FC WH44083FCNW WH4508FC WH4508FCNW WH45083FC WH45083FCNW				4520-2048-000 WH44043FC WH44043FCNW WH44083FC WH44083FCNW WH45043FC WH45043FCNW WH4508FC WH4508FCNW	1016-11243-500 ALL MODELS			
THERMOSTAT 5813-2027-001 3 PHASE MODELS											





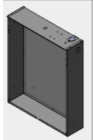







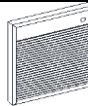

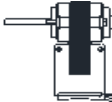
WHB (FRA-F)

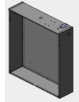
GRILLE	MANUAL LIMIT	FAN BLADE	THERMOSTAT	FAN DELAY	RELAY
					
1016-11226-000 WHB3150FC WHB3180C WHB3307FC WHB3404FC WHB34043FC WHB3407FC WHB3408FC WHB34083FC WHB3504FC WHB35043FC WHB3507FC WHB3508FC WHB35083FC	4520-2027-000 WHB3150FC WHB3180C WHB3307FC WHB3404FC WHB34043FC WHB3407FC WHB3408FC WHB34083FC WHB3504FC WHB35043FC WHB3507FC WHB3508FC WHB35083FC	490030103 WHB3150FC WHB3180C WHB3307FC WHB3404FC WHB34043FC WHB3407FC WHB3408FC WHB34083FC WHB3504FC WHB35043FC WHB3507FC WHB3508FC WHB35083FC	5813-2059-000 WHB3150FC WHB3180C WHB3307FC WHB3404FC WHB34043FC WHB3407FC WHB3408FC WHB34083FC WHB3504FC WHB35043FC WHB3507FC WHB3508FC WHB35083FC	410074000 WHB3150FC WHB3180C WHB3307FC WHB3404FC WHB34043FC WHB3407FC WHB3408FC WHB34083FC WHB3504FC WHB35043FC WHB3507FC WHB3508FC WHB35083FC	410101002 WHB34043FC WHB35043FC WHB34083FC WHB3508FC WHB35083FC
DISCONNECT SWITCH		ELEMENT		MOTOR	
					
410170001 WHB3150FC WHB3180C WHB3307FC WHB3404FC WHB3407FC WHB3408FC WHB3504FC WHB3507FC	5216-2019-000 WHB34043FC WHB34083FC WHB35043FC WHB3508FC WHB35083FC	302012827 WHB3150FC 302012807 WHB3408FC 302012828 WHB3180C 302012806 WHB3307FC 302012808 WHB3404FC 302012809 WHB3407FC 302012810 WHB3504FC	302012811 WHB3507FC 1802-2075-800 WHB34083FC 1802-2075-801 WHB3508FC WHB35083FC 1802-2075-802 WHB34043FC 1802-2075-803 WHB35043FC	3900-2010-003 WHB3150FC WHB3180C 3900-2010-001 WHB3307FC WHB3507FC WHB3407FC 3900-2010-000 WHB3404FC WHB3408FC WHB3504FC	3900-2002-518 WHB34043FC WHB34083FC WHB35043FC WHB3508FC WHB35083FC 
AUTO LIMIT	RELAY MODELS BEFORE 2020		BACK BOX		
					
4520-2048-000 WHB34043FC WHB35043FC WHB34083FC WHB3508FC WHB35083FC	5018-2017-000 WHB34043FC WHB35043FC	5018-2017-004 WHB34083FC WHB3508FC WHB35083FC	1016-11243-500 ALL MODELS		
PARTS KIT P/N 1205-11031-001 (KNOB, GRILLE SCREWS, AND PLUG BUTTONS)					

WHB SERIES (SRA)

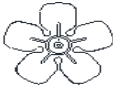











GRILLE		KNOB		ELEMENT		MOTOR	
							
1016-11228-000 WHB1101FC WHB1151FC WHB1157FC WHB1201FC WHB1202FC WHB1207FC WHB1208FC		3301-11015-001 WHB1101FC WHB1151FC WHB1157FC WHB1201FC WHB1202FC WHB1207FC WHB1208FC		302023801 WHB1101FC	302023805 WHB1202FC	490062001 WHB1101FC WHB1151FC WHB1201FC	490062004 WHB1157FC WHB1207FC
				302023802 WHB1151FC	302023806 WHB1207FC		
				302023803 WHB1157FC	302023808 WHB1201FC		
				302023804 WHB1208FC			
LIGHT		THERMAL FUSE		MANUAL LIMIT		THERMOSTAT	
							
3510-2017-007 WHB1101FC WHB1151FC WHB1201FC		3510-2017-006 WHB1157FC WHB1202FC WHB1207FC WHB1208FC		4520-2030-000 WHB1101FC WHB1151FC WHB1157FC WHB1201FC WHB1202FC WHB1207FC WHB1208FC		5813-2001-000 WHB1101FC WHB1151FC WHB1157FC WHB1202FC WHB1207FC WHB1208FC	
				4520-11016-000 WHB1101FC WHB1151FC WHB1157FC WHB1201FC WHB1202FC WHB1207FC WHB1208FC		5813-2022-000 WHB1201FC	
DISCONNECT SWITCH		FAN BLADE		FAN DELAY		BACK BOX	
							
410170001 ALL MODELS		490061001 ALL MODELS		410074000 ALL MODELS		1217-2027-507 ALL MODELS	
PARTS KIT							
1205-11032-000 ALL MODELS							

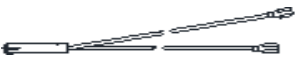

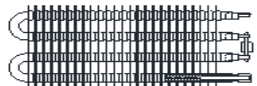
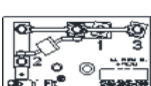
SRA ARCHITECTURAL SERIES (SWH)

KNOB		GRILLE		ELEMENT		
						
3301-11015-003 SWH1012FC SWH1512FC SWH1527FC SWH1812FC SWH2020FC SWH2024FC SWH2027FC	3301-2052-002 SWH1012AG SWH1512AG SWH1527AG SWH1812AG SWH2020AG SWH2024AG SWH2027AG SWH1012AGA SWH1512AGA SWH1527AGA SWH1812AGA SWH2020AGA SWH2024AGA SWH2027AGA	1016-11227-000 SWH1012FC SWH1512FC SWH1527FC SWH1812FC SWH2020FC SWH2024FC SWH2027FC	2501-2075-000 SWH1012AG SWH1512AG SWH1527AG SWH1812AG SWH2020AG SWH2024AG SWH2027AG SWH1012AGA SWH1512AGA SWH1527AGA SWH1812AGA SWH2020AGA SWH2024AGA SWH2027AGA	302023801 SWH1012AG SWH1012AGA SWH1012FC 302023804 SWH2020AG SWH2020AGA SWH2020FC 302023808 SWH1812AG SWH1812AGA SWH1812FC	302023802 SWH1512AG SWH1512AGA SWH1512FC 302023805 SWH2024AG SWH2024AGA SWH2024FC	302023803 SWH1527AG SWH1527AGA SWH1527FC 302023806 SWH2027AG SWH2027AGA SWH2027FC
LIGHT				MOTOR	DISCONNECT SWITCH	
						
3510-2008-002 SWH1527AG	3510-2008-003 SWH1012AG SWH1512AG SWH1812AG SWH2020AG SWH2024AG SWH2027AG	3510-2017-007 SWH1012AGA SWH1512AGA SWH1812AGA SWH1012FC SWH1512FC SWH1812FC	3510-2017-006 SWH1527AGA SWH2020AGA SWH2024AGA SWH2027AGA SWH1527FC SWH2020FC SWH2024FC SWH2027FC	490062001 SWH1012AG SWH1512AG SWH1812AG SWH1012AGA SWH1512AGA SWH1812AGA SWH1012FC SWH1512FC SWH1812FC 490062002 SWH2020AG SWH2020AGA SWH2020FC	490062003 SWH2024AG SWH2024AGA SWH2024FC 490062004 SWH1527AG SWH2027AG SWH1527AGA SWH2027AGA SWH1527FC SWH2027FC	410170001 ALL MODELS BACK BOX  1217-2027-507 ALL MODELS PARTS KIT 1205-11032-001 ALL MODELS
FAN DELAY	HI LIMIT	MANUAL LIMIT	FAN BLADE	THERMAL FUSE	THERMOSTAT	
						
410074000 ALL MODELS	410143000 SWH1012AG SWH1512AG SWH1527AG SWH1812AG SWH2020AG SWH2024AG SWH2027AG	4520-11016-000 SWH1012AGA SWH1512AGA SWH1527AGA SWH1812AGA SWH2020AGA SWH2024AGA SWH2027AGA SWH1012FC SWH1512FC SWH1527FC SWH1812FC SWH2020FC SWH2024FC SWH2027FC	490061001 ALL MODELS	4520-2030-000 SWH1012AGA SWH1512AGA SWH1527AGA SWH1812AGA SWH2020AGA SWH2024AGA SWH2027AGA SWH1012FC SWH1512FC SWH1527FC SWH1812FC SWH2020FC SWH2024FC SWH2027FC	5813-2022-000 SWH1812AG SWH1812AGA SWH1812FC	5813-2001-000 SWH1012AG SWH1512AG SWH1527AG SWH2020AG SWH2024AG SWH2027AG SWH1012AGA SWH1512AGA SWH1527AGA SWH2020AGA SWH2024AGA SWH2027AGA SWH1012FC SWH1512FC SWH1527FC SWH2020FC SWH2024FC SWH2027FC
						

VFK-SERIES



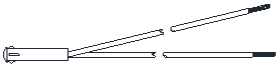
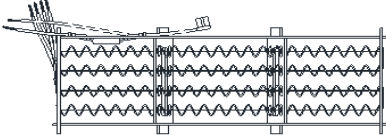
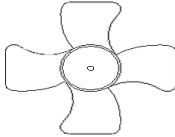
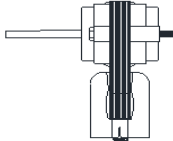
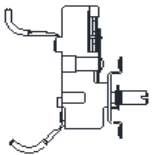
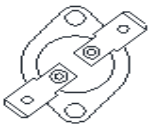
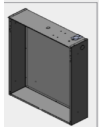

GRILLE			KNOB		FAN DELAY			MANUAL LIMIT
1402-2239-000	1402-2152-000	2501-11028-000	3301-2030-001		3301-11014-001	4520-2024-000	410074000	4520-2027-000
K151	K204	K151FC	K151	K204A	K151FC	K4043	K204	K406FC
K157A	K207	K204FC	K204	K207A	K204FC	K4043A	K204A	K408
K204A	K208	K303FC	K207	K208A	K303FC	K4083	K204FC	K408A
K207A	K303	K304FC	K208	K303A	K304FC	K4083A	K208	K408FC
K208A	K304	K306FC	K303	K304A	K306FC	K4083FC	K208A	K483
K303A	K306	K403FC	K304	K306A	K403FC	K4843	K303	K483A
K304A	K307	K404FC	K306	K307A	K404FC	K4843A	K303A	K483FC
K306A	K403	K406FC	K307	K403A	K406FC	K488	K303FC	K484
K307A	K404	K408FC	K403	K404A	K408FC	K4883	K304	K484A
K403A	K4043	K4083FC	K404	K4043A	K4083FC	K488A	K304A	K484FC
K404A	K406	K483FC	K4043	K406A	K483FC	K4883A	K304FC	K486
K4043A	K408	K484FC	K406	K407A	K484FC	K488FC	K306	K486A
K406A	K4083	K486FC	K408	K408A	K486FC	K4883FC	K306A	K486FC
K407A	K483	K487FC	K4083	K4083A	K487FC		K306FC	K207
K408A	K484	K488FC	K483	K483A	K488FC		K403	K207A
K4083A	K4843	K4883FC	K484	K484A	K4883FC		K403A	K307
K483A	K486		K4843	K4843A			K403FC	K307A
K484A	K487		K486	K486A			K404	K487
K4843A	K488		K487	K487A			K404A	K487A
K486A	K4883		K488	K488A			K404FC	K487FC
K487A			K4883	K4883A			K406	K157A
K488A			K157A				K406A	K407A
K4883A							K151FC	
ELEMENTS				MOTOR				FAN BLADE
302012827	302015802	302015803	302015801	3900-2010-003	3900-2010-000	3900-2010-001	3900-2002-518	490030103
K151	K204	K207	K208	K151	K204	K207	K4043	ALL MODELS
K151FC	K204A	K207A	K208A	K151FC	K204A	K207A	K4043A	BACK BOX
302012819	K204FC	302012809	302012806		K204FC	K406	K4083	
K303	302012820	K304	K307		K208	K406A	K4083A	1016-11243-500
K303A	K306	K304A	K307A		K208A	K406FC	K4083FC	ALL MODELS
K303FC	K306A	K304FC	302012808		K303	K408	K483	PARTS KIT
302012821	K306FC	K407A	K404		K303A	K487A	K483A	
K403	1802-2075-802	1802-2075-800	K404A		K408A	K487FC	K4843A	
K403A	K4043	K4083	K404FC		K303FC	K157A	K488	
K403FC	K4043A	K4083A	302012807		K304	K483	K4883	
302012822	302012823	302012810	K408		K304A	K483A	K488A	
K406	K483	K483FC	K408A		K304FC	K483FC	K4883A	
K406A	K483A	K484	K408FC		K306	K484	K488FC	
K406FC	K483FC	K484A	1802-2075-803		K306A	K484A	K4883FC	1205-11031-002
302012824	302012811	K484FC	K4843		K306FC	K484FC		ALL MODELS
K486	K487	1802-2075-801	K4843A		K403	K486		
K486A	K487A	K488			K403A	K486A		
K486FC	K487FC	K4883			K403FC	K486FC		
302015806		K488A			K404			
K157A		K4883A						
		K488FC						
		K4883FC						
THERMOSTAT		TRANSFORMER		RELAY		RELAY MODELS BEFORE 2020		
410168002	5813-2027-000		490015017	490015013	410101002		5018-2017-000	5018-2017-004
K4043	K204	K404FC	K303	K306	K4043	K4083	K4043	K4083
K4043A	K204A	K406	K403	K406	K4043A	K4083A	K4043A	K4083A
K4843	K204FC	K406A	K483	K486	K4843	K4083FC	K4843	K4083FC
K4843A	K208	K406FC	K303A	K306A	K4843A	K488	K4843A	K488
	K208A	K408	K403A	K406A		K4883		K4883
	K303	K408A	K483A	K486A		K488A		K488A
	K303A	K408FC	K303FC	K306FC		K4883A		K4883A
	K303FC	K483	K403FC	K406FC		K488FC		K488FC
	K304	K483A	K483FC	K486FC		K4883FC		K4883FC
	K304A	K483FC						
	K304FC	K484			VFK-F		VFK	
	K306	K484A						
	K306A	K484FC						
	K306FC	K486						
	K403	K486A						
	K403A	K486FC						
	K403FC	K207						
	K404	K151FC						
	K404A							





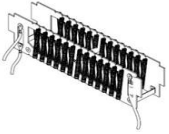
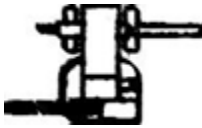

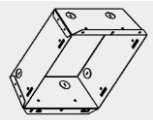

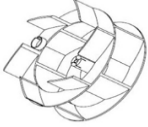

GFR SERIES								
KNOB		GRILLE			LIGHT			
								
3301-2014-004 R1500T2 R2004T2 R2404T2 R1500T2A R2004T2A R2404T2A R1500T2B R2004T2B R2404T2B	3301-11015-002 R1500T2FC R2004T2FC R2404T2FC	2501-11031-000 R1500FC R1500T2FC R2004FC R2004IFFC R2004T2FC R2404FC R2404IFFC R2404T2FC	2501-2026-000 R1500 R1500T2 R2004 R2004IF R2004T2 R2404 R2404IF R2404T2 R1500A R1500T2A R2004A R2004IFA		R2004T2A R2404A R2404IFA R2404T2A R1500B R1500T2B R2004B R2004IFB R2004T2B R2404B R2404IFB R2404T2B	3510-2010-000 R1500 R1500T2 R1500A R1500T2A R1500B R1500T2B R1500FC R1500T2FC	3510-2010-001 R2004 R2004IF R2004T2 R2004A R2004IFA R2004T2A R2004B R2004IFB R2004T2B R2004FC R2004IFFC R2004T2FC	R2404 R2404IF R2404T2 R2404A R2404IFA R2404T2A R2404B R2404IFB R2404T2B R2404FC R2404IFFC R2404T2FC
BLOWER ASM.				ELEMENT			CLIP N FIT BOARD	
								
1225-2002-000 R1500 R1500T2 R1500A R1500T2A R1500B R1500T2B R1500FC R1500T2FC	R2404A R2404IFA R2404T2A R2404B R2404IFB R2404T2B R2404FC R2404IFFC R2404T2FC	1225-2002-001 R2004 R2004IF R2004T2 R2404 R2404IF R2404T2 R2004A R2004IFA R2004T2A	R2004B R2004IFB R2004T2B R2004FC R2004IFFC R2004T2FC	302023802 R1500 R1500T2 R1500A R1500T2A R1500B R1500T2B R1500FC R1500T2FC	302023805 R2004 R2004IF R2004T2 R2004A R2004IFA R2004T2A R2004B R2004IFB R2004T2B R2004FC R2004IFFC R2004T2FC	302023814 R2404 R2404IF R2404T2 R2404A R2404IFA R2404T2A R2404B R2404IFB R2404T2B R2404FC R2404IFFC R2404T2FC	1249-2005-000 ALL MODELS BACK BOX  1217-2044-000 ALL MODELS PARTS KIT 1205-11033-000 ALL MODELS	
THERMOSTAT	TEMPERATURE REGULATOR			HI-LIMIT				
								
410130001 R1500T2 R2004T2 R2404T2 R1500T2A R2004T2A R2404T2A R1500T2B R2004T2B R2404T2B R1500T2FC R2004T2FC R2404T2FC	410143000 R1500 R1500T2 R2004 R2004IF R2004T2 R1500A R1500T2A R2004A R2004IFA R2004T2A		4520-2029-000 R2404 R2404IF R2404T2 R2404A R2404IFA R2404T2A R2404B R2404IFB R2404T2B R2404FC R2404IFFC R2404T2FC	4520-2025-000 R1500 R1500T2 R2004 R2004IF R2004T2 R1500A R1500T2A R2004A R2004IFA R2004T2A	4520-2025-001 R2404 R2404IF R2404T2 R2404A R2404IFA R2404T2A	4520-11010-000 R1500B R1500T2B R1500FC R1500T2FC	4520-11010-001 R2004B R2004IFB R2004T2B R2004FC R2004IFFC R2004T2FC R2404B R2404IFB R2404T2B R2404FC R2404IFFC R2404T2FC	
								





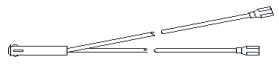
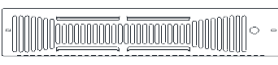
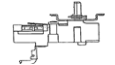

SED SERIES					
KNOB		GRILLE		LIGHT	
					
3301-2044-001 D1012C D1024C D1012CA D1024CA	3301-2039-002 D1012W D1512 D2024 D1012WA D1024WA D1512A D2024A	2501-2054-001 D1012C D1024C D1512CR D1012CA D1024CA D1512CRA	2501-2054-000 D1012W D1512 D2024 D1012WA D1024WA D1512A D2024A	3510-2017-002 D1012C D1012W D1512 D1512CR D1012CA D1012WA D1512A D1512CRA	3510-2017-003 D1024C D2024 D1024CA D1024WA D2024A
ELEMENT			FAN BLADE	MOTOR	
					
1802-2124-003 D1012C D1012W D1012CA D1012WA	1802-2124-005 D1024C D2024 D1024CA D1024WA D2024A	1802-2124-000 D1512 D1512CR D1512A D1512CRA	1210-2008-000 ALL MODELS	3900-2037-000 D1012C D1012W D1512 D1512CR D1012CA D1012WA D1512A D1512CRA	3900-2037-001 D1024C D2024 D1024CA D1024WA D2024A
THERMOSTAT		LIMIT			BACK BOX
					
410130001 D1012C D1012W D1512 D1012CA D1012WA D1512A D1024C D2024		4520-11009-000 D1012C D1012W D1512 D1512CR D1024C D2024		4520-11009-001 D1012CA D1012WA D1512A D1512CRA D1024CA D1024WA D2024A	1217-2062-000 ALL MODELS PARTS KIT 1205-2049-501 ALL MODELS



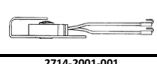
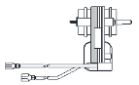

COZ-E WALL HEATER









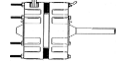

ELEMENT (INCLUDES LIMIT & ONE SHOT FUSE)		MOTOR		GRILLE
				
1802-11014-011 CZ1012TB	1802-11014-010 CZ1512TB	3900-11032-000 CZ1012IF CZ1012T CZ1512IF CZ1512T	3900-11032-001 CZ1048IF CZ1048T CZ1548IF CZ1548T CZ2048IF CZ2048T	2501-11024-000 ALL MODELS
1802-11014-014 CZ1048TB	1802-11014-013 CZ1548TB			BACK BOX
				
				1217-11030-000 ALL MODELS
THERMOSTAT	FAN IMPELLER	PARTS KIT		
		PICTURE NOT AVAILABLE		
5813-2090-000 CZ1012T CZ1048T CZ1512T CZ1548T CZ2048T	2002-11004-000 ALL MODELS	1205-11028-500 CZ1012T CZ1048T CZ1512T CZ1548T CZ2048T		

QTS SERIES									
ELEMENTS		MOTOR ASSEMBLY		HI-LIMIT	SELF HOLD LIMIT	FAN DELAY			
									
302023811 S1100 S1100A S1100B S1100C S1100CNW	302023803 S1104 S1104A S1104B S1104C S1104CNW	1225-2002-000 S1100 S1100A S1100B S1100C S1100CNW	1225-2002-001 S1104 S1104A S1104B S1104C S1104CNW	4520-2031-000 S1100 S1100A S1100B S1104 S1104A S1104B S1500 S1500A S1500B S1500C S1500T S1500TA S1500TB S1500TC S1500TCNW	4520-11011-000 S1100C S1100CNW S1500C S1500TC S1500TCNW	1414-2020-000 S1100 S1100A S1104 S1104A S1500 S1500A S1500T S1500TA S1504 S1504A S1504T S1504TA	410074000 S1100B S1100C S1100CNW S1104B S1104C S1104CNW S1500B S1500C S1500TB S1500TC S1500TCNW S1504B S1504C S1504TB S1504TCNW		
302023802 S1500 S1500A S1500B S1500C S1500T S1500TA S1500TB S1500TC S1500TCNW		302023806 S1504 S1504A S1504B S1504C S1504T S1504TA S1504TB S1504TC S1504TCNW		2501-2039-000 S1500 S1500A S1500B S1500C S1500T S1500TA S1500TB S1500TC S1500TCNW		2501-2039-001 S1500C S1504 S1504A S1504B S1504C S1504T S1504TA S1504TB S1504TC			
PILOT LIGHT 		GRILLE 		THERMOSTAT 		KNOB 		THERMAL CUTOFF 	
3510-2010-000 S1100A S1100B S1100C S1100CNW S1500A S1500B S1500C S1500TA S1500TB S1500TC S1500TCNW	3510-2010-001 S1104 S1104A S1104B S1104C S1104CNW S1504 S1504A S1504B S1504C S1504T S1504TA S1504TB S1504TC S1504TCNW	2501-2039-000 S1100 S1100A S1100B S1100C S1104 S1104A S1104B S1104C S1500 S1500A S1500B S1500C S1500T S1500TA S1500TB S1500TC S1500TCNW		2501-2039-001 S1100CNW S1104CNW S1500CNW S1504CNW		410129001 S1500T S1500TA S1500TB S1500TC S1500TCNW S1504T S1504TA S1504TB S1504TC S1504TCNW	3301-2020-006 S1500T S1500TA S1500TB S1500TC S1500TCNW S1504T S1504TA S1504TB S1504TC S1504TCNW	4520-2030-000 ALL MODELS 	











FDI SERIES				
BLADE	ELEMENT		GRILLE	BUZZER
				
1210-0046-000 I1500 I1504	1802-5032-000 I1500	1802-5032-004 I1504	2501-5016-001 I1500 I1504	2714-2001-001 I1500 I1504
MOTOR 		ONE SHOT FUSE BLUE DOT 	HI LIMIT WHITE DOT 	
3900-2025-000 I1500	3900-2025-001 I1504	4520-2041-000 I1500 I1504	4520-5015-001 I1500 I1504	









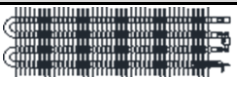

HT SERIES PUMP HOUSE HEATER		
ELEMENT	KNOB	THERMOSTAT
		
1802-2091-000	3301-2020-006	5813-2062-000

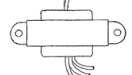





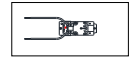



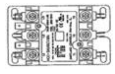

* Neutral grey finish.

CFWF (OBSOLETE)					
TOP FRONT PANEL	BOTTOM FRONT PANEL	TOP TRIM PANEL	MOTOR	RELAY	TRANSFORMER
					
1402-2312-000 CFWF920 CFWF920A	1402-2313-000 CFWF920 CFWF920A	5806-2004-000 CFWF920 CFWF920A	3900-2036-000 CFWF920 CFWF920A	5018-2017-001 CFWF920 CFWF920A	5814-0003-000 CFWF920 CFWF920A
HI-LIMIT 	MANUAL RESET LIMIT 	ELEMENT 	FAN BLADE 	PILOT LIGHT 	CERAMIC LIMITS 
4520-2053-000 CFWF920	4520-2027-000 CFWF920A	1802-2117-101 CFWF920 CFWF920A	1210-2009-001 CFWF920 CFWF920A	3510-2018-000 CFWF920 CFWF920A	4520-2052-000 CFWF920 CFWF920A



QCH (U SERIES)						
GRILLE		PLASTIC COVER (2 REQ)	ELEMENTS		MOTOR	
						
1402-2121-000 U1000 U1000A U1500 U1500A U1507 U1800 U2004 U2004A U2007 U2007A U2008	1016-11228-002 U1000FA U1500FA U2004FA U2007FA	1402-2119-000 U1000 U1000A U1500 U1500A U1507 U1800 U2004 U2004A U2007 U2007A U2008	302023812 U1000 U1000A U1000FA	302023803 U1507 302023808 U1800	490062001 U1000 U1000A U1000FA U1500 U1500A U1500FA U1800	490062003 U2004 U2004A U2004FA
			302023802 U1500 U1500A U1500FA	302023806 U2007 U2007A U2007FA	490062004 U1500	490062004 U2007 U2007A U2007FA
			302023805 U2004 U2004A U2004FA	302023804 U2008	490062004 U1507	490062002 U2008
LIGHT	FAND DELAY	HI-LIMIT	FAND BLADE	DISCONNECT SW	SOCKET ASSEMBLY	
						
3510-2008-003 U1000A U1000FA U1500A U1500FA	3510-2008-002 U2004A U2004FA U2007A U2007FA	410074000 ALL MODELS	410143000 ALL MODELS	490061001 ALL MODELS	410170001 ALL MODELS	480108903 ALL MODELS

QFF (F SERIES)						
MOTOR	ELEMENT			DISCONNECT		
						
3900-2002-520 F1500	3900-2002-500 F2004	302012827 F1500	302012821 F4003	302012811 F4807	410170001 F1500	5216-2019-000 F3003
3900-2002-501 F1507 F2007 F3007 F4007 F4807	F2008 F3003 F3006 F4003 F4004 F4006 F4008	302015806 F1507	302012808 F4004	1802-2075-802 F40043	F1507 F2004 F2007 F2008 F3007 F4004 F4007 F4008 F4804 F4807	F3006 F4003 F40043 F4006 F40083 F4803 F48043 F4806 F4808 F48083 F48483LV
3900-2002-518 F40043 F40083 F48043 F4808 F48083	F4008 F4803 F4804 F4806	302015801 F2008	302012807 F4008	1802-2075-801 F4808 F48083		
	3900-2010-000 F48483 F48483LV	302012819 F3003	302012823 F4803	1802-2075-804 F48483 F48483LV		
3900-2010-000 F48483 F48483LV		302012820 F3006	302012810 F4804			
		302012806 F3007	302012824 F4806			
POWER TR.	SECONDARY TR.	RELAY MODELS BEFORE 2020	RELAY	AUTO LIMIT	HI-LIMIT	FAN DELAY
						
490015017 F3003 F4003 F4803	490065002 F48483LV UNIT MOUNTED T'STAT	5018-2017-000 F40043 F48043 F48483	410101002 F40043 F48043 F48483 F4808 F48083	4520-2048-000 F40043 F48043 F48483 F4808 F48083	410169001 ALL MODELS	410074000 ALL MODELS
490015013 F3006 F4006 F4806		5018-2017-004 F40083 F4808 F48083	410101001 F48483LV			
490015022 F48483 F48483LV	FT1 ASSEMBLY 5813-2028-000 FFT2 ASSEMBLY 5813-2029-000	5018-2017-001 F48483LV			1402-2139-001 ALL MODELS	490030103 ALL MODELS

FFCH (500 SERIES)						
ELEMENT	MOTOR	RELAY	OUTLET GRILLE (2 REQ'D)	LOUVER GUIDES NAV W.	LOUVER GUIDES NOR W.	
						
302012802 542	302012813 552	5018-11006-000 542	2501-2020-001 NAVAJO WHITE	1215-2059-000 REA (2 REQ'D)	1215-2059-002 REA (2 REQ'D)	
302012803 547	302012814 557	5018-11006-000 548	2501-2020-002 NORTHERN WHITE	1215-2059-001 SEA (2 REQ'D)	1215-2059-003 SEA (2 REQ'D)	
302012801 548	302012812 558	5018-11006-001 547	GRILLE PANEL	GRILLE PANEL	THERMOSTAT	
		3900-2011-001 547				
		3900-2011-001 557	NAVAJO SEB 2016-11147-000 NORTHERN SEBNW 4513-11057-001	NAVAJO REB 4513-11057-001 NORTHERN REBNW 4513-11057-000	500T ALL MODELS	
FAN DELAY	FAN BLADE	HI-LIMIT	POWER BLOCK			
						
1414-2039-000 ALL MODELS	1210-2000-000 ALL MODELS	4520-0011-000 ALL MODELS	5823-0004-000 MODELS NOT ENDING IN A			

* MODELS ENDING IN (A) USE SAME PARTS BUT DO NOT HAVE POWER BLOCKS

CUH900 SERIES



ELEMENTS













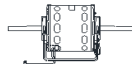













MODEL	NO. REQ.	208V	NO. REQ.	240V	NO. REQ.	277V	NO. REQ.	347V	NO. REQ.	380V	NO. REQ.	480V	NO. REQ.	600V
935														
2KW	1	1802-2083-100	1	1802-2083-101	1	1802-2083-114	1	1802-2083-103	1	1802-2083-101	1	1802-2083-114	1	1802-2083-103
3KW	1	1802-2083-107	1	1802-2083-108	1	1802-2083-116	1	1802-2083-105	1	1802-2083-108	1	1802-2083-116	1	1802-2083-105
4KW	1	1802-2083-106	1	1802-2083-107	1	1802-2083-108	1	1802-2083-109	1	1802-2083-107	1	1802-2083-118	1	1802-2083-109
5KW	1	1802-2083-110	1	1802-2083-111	1	1802-2083-120	1	1802-2083-113	1	1802-2083-111	1	1802-2083-120	1	1802-2083-113
6KW	2	1802-2083-107	2	1802-2083-108	2	1802-2083-116	2	1802-2083-105	2	1802-2083-108	2	1802-2083-116	2	1802-2083-105
7KW	1	1802-2083-106	1	1802-2083-107	1	1802-2083-116	1	1802-2083-109	1	1802-2083-107	1	1802-2083-116	1	1802-2083-109
	1	1802-2083-107	1	1802-2083-108	1	1802-2083-118	1	1802-2083-109	1	1802-2083-108	1	1802-2083-118	1	1802-2083-109
8KW	1	1802-2083-107	1	1802-2083-108	1	1802-2083-116	1	1802-2083-105	1	1802-2083-108	1	1802-2083-116	1	1802-2083-105
	1	1802-2083-110	1	1802-2083-111	1	1802-2083-120	1	1802-2083-113	1	1802-2083-111	1	1802-2083-120	1	1802-2083-113
945														
4KW	2	1802-2083-100	2	1802-2083-101	2	1802-2083-114	2	1802-2083-103	2	1802-2083-101	2	1802-2083-114	2	1802-2083-103
6KW	2	1802-2083-107	2	1802-2083-108	2	1802-2083-116	2	1802-2083-105	2	1802-2083-108	2	1802-2083-116	2	1802-2083-105
8KW	2	1802-2083-106	2	1802-2083-107	2	1802-2083-108	2	1802-2083-109	2	1802-2083-107	2	1802-2083-118	2	1802-2083-109
10KW	2	1802-2083-110	2	1802-2083-111	2	1802-2083-120	2	1802-2083-113	2	1802-2083-111	2	1802-2083-120	2	1802-2083-113
12KW	4	1802-2083-107	4	1802-2083-108	4	1802-2083-116	4	1802-2083-105	4	1802-2083-108	4	1802-2083-116	4	1802-2083-105
14KW	2	1802-2083-106	2	1802-2083-107	2	1802-2083-116	2	1802-2083-105	2	1802-2083-107	2	1802-2083-116	2	1802-2083-105
	2	1802-2083-107	2	1802-2083-108	2	1802-2083-118	2	1802-2083-109	2	1802-2083-108	2	1802-2083-118	2	1802-2083-109
16KW	2	1802-2083-107	2	1802-2083-108	2	1802-2083-116	2	1802-2083-105	2	1802-2083-108	2	1802-2083-116	2	1802-2083-105
	2	1802-2083-110	2	1802-2083-111	2	1802-2083-120	2	1802-2083-113	2	1802-2083-111	2	1802-2083-120	2	1802-2083-113
58" AND LARGER HEATERS CONTACT FACTORY WITH CFID# ON UNIT'S NAMEPLATE														

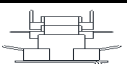
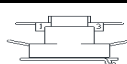

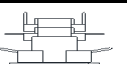
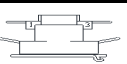
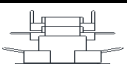



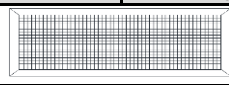
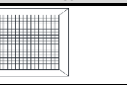



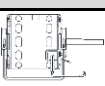
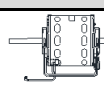
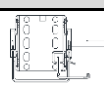
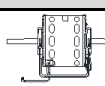
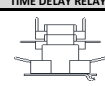
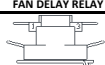
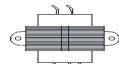

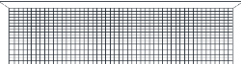
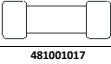
LOUVERED PANELS

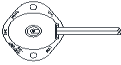
DESERT TAN	35"	4513-2114-T35	NAVAJO WHITE	35"	4513-2114-P35	NORTHERN WHITE	35"	4513-2114-W35	STAT BRONZE	35"	4513-2114-S35	
	45"	4513-2114-T45		45"	4513-2114-P45		45"	4513-2114-W45		45"	4513-2114-S45	
	58"	4513-2114-T58		58"	4513-2114-P58		58"	4513-2114-W58		58"	4513-2114-S58	
	78"	4513-2114-T78		78"	4513-2114-P78		78"	4513-2114-W78		78"	4513-2114-S78	
ALUMINUM	35"	4513-2114-A35	BLACK	35"	4513-2114-B35	CHARCOL GREY	35"	4513-2114-G35	NEUTRAL GREY	35"	4513-2114-N35	
	45"	4513-2114-A45		45"	4513-2114-B45		AR. NEUTRAL GREY	45"		4513-2114-NA45	45"	4513-2114-N45
	58"	4513-2114-A58		58"	4513-2114-B58		78"	4513-2114-N78		58"	4513-2114-N58	
			78"	4513-2114-B78			78"	4513-2114-N78				

PANEL GRILLES NEW MODELS







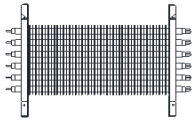
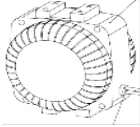

NORTHERN WHITE	35"	2501-11040-000W	BEIGE	35"	2501-11040-000N	BLACK	35"	2501-11040-000B	ALUMINUM	35"	2501-11040-000A
	45"	2501-11040-001W		45"	2501-11040-001N		45"	2501-11040-001B		45"	2501-11040-001A
	58"	2501-11040-003W		58"	2501-11040-003N		58"	2501-11040-003B		58"	2501-11040-003A
	78"	2501-11040-004W		78"	2501-11040-004N		78"	2501-11040-004B		78"	2501-11040-004A
STAT BRONZE	35"	2501-11040-000S									
	45"	2501-11040-001S									
	58"	2501-11040-003S									
	78"	2501-11040-004S									

CUH900 CONTINUED						
PRIMARY TRANSFORMER		SEC. TRANSFORMER		MOTORS		BLOWER WHEEL
						
CONTACT FACTORY WITH CFID# ON UNIT'S NAMEPLATE OR TRANSFORMER LABEL, PART NUMBERS ARE GENERALLY ON THE PARTS LABEL		490026910 MODELS WITH 24V CONTR.		2408/240V 3900-2032-000 277V 3900-2032-001 480V 3900-2032-002 SEE MOTOR LABEL SINGLE SHAFT	2408/240V 3900-2033-000 277V 3900-2033-001 480V 3900-2033-002 SEE MOTOR LABEL DOUBLE SHAFT	490047001 ALL MODELS
DAMPER MOTOR	DAMPER RHEOSTAT	DAMPER RHEOSTAT KNOB	THERMOSTAT SPST	THERMOSTAT 2STG	THERMOSTAT KNOB	PLUG BUTTON
						
3900-2023-000 MODELS WITH AIR DAMPER	410104001 MODELS WITH AIR DAMPER	482084001 MODELS WITH AIR DAMPER	410127001 SINGLE STAGE MODELS	5813-2008-000 TWO STAGE MODELS	3301-2020-001 ALL MODELS	4506-2012-000 ALL MODELS
DAMPER ROCKER SW	FAN AUTO/ON SW	ON/OFF SW	HIGH/LOW SW	DOOR SAFETY SW	AUTO HIGH LIMIT	MANUAL LIMIT
						
410131001 MODELS WITH AIR DAMPER	5216-2029-001 ALL MODELS	5216-2029-001 ALL MODELS	5216-2029-000 SINGLE STAGE MODELS	5216-2028-000 ALL MODELS	4520-2048-000 ALL MODELS	4520-2017-000 ALL MODELS
FAN AUTO RELAY (120V)	FAN DELAY RELAY(120V)	POWER RELAY (120)	FAN AUTO RELAY (24V)	FAN DELAY RELAY (24V)	POWER RELAY (24)	NIGHT SETBACK RELAY
						
410101003 MODELS WITH 120V CONTROL	410171002 MODELS WITH 120V CONTROL	410101003 MODELS WITH 120V CONTROL	410101001 MODELS WITH 24V CONTROL	410171001 MODELS WITH 24V CONTROL	410101001 MODELS WITH 24V CONTROL	410101001 MODELS WITH N.S. RELAY
FUSE	FILTER	FILTER REUSABLE	DISCONNECT SW		NOTES: * TAKES TWO MOTORS ** TAKES ONE OF EACH TYPE MOTOR  <i>Optional model with architectural styled grille shown</i>	
						
481001017 ALL MODELS	2010-7008-006 CU935	2010-7009-006 CU935	30 AMP 60 AMP 100 AMP			
FUSE HOLDER 	2010-7008-007 CU945	2010-7009-007 CU945	5216-2033-000 5216-2033-001 5216-2033-002			
480087001 ALL MODELS	2010-7008-008 CU958	2010-7009-008 CU958				
	2010-7008-009 CU968	2010-7009-009 CU968				
	2010-7008-010 CU978	2010-7009-010 CU978				

CUH 900 SERIES STOCK MODELS						
ELEMENT		MOTOR				TIME DELAY RELAY
						
1802-2083-110 S93505203FFB S94510203FFB	1802-2083-120 S93505483FFB S94510483FFB	3900-2032-000 S93505203FFB S93505243FFB S93505483FFB S93505603FFB	3900-2033-000 S94510203FFB S94510243FFB S94510483FFB S94510603FFB	3900-2032-001 S93505271FFNC	3900-2033-001 S94510271FFNC	410101001 ALL MODELS
1802-2083-111 S93505243FFB S94510243FFB	S93505271FFNC S93505483FFB S94510271FFNC	S93505483FFB S93505603FFB	S94510483FFB S94510603FFB	3900-2032-001 S93505483FFNC	3900-2033-002 S94510483FFNC	FAN DELAY RELAY 
1802-2083-121 S93505603FFB S94510603FFB	S94510483FFNC					410171001 ALL MODELS
PRI. TRANSFORMER	CAPACITOR		FILTER		FUSE	
						
490015025 S93505483FFB S94510483FFB	490015026 S93505603FFB S94510603FFB	1432-0002-003 S93505203FFB S93505243FFB S93505483FFB S93505603FFB S94510243FFB S94510483FFB S94510603FFB	1432-0002-001 S94510203FFB	2010-7008-006 S93505203FFB S93505243FFB S93505483FFB S93505603FFB	2010-7008-007 S94510203FFB S94510243FFB S94510483FFB S94510603FFB	481001017 ALL MODELS
490026002 S93505271FFNC S94510271FFNC	5814-0003-002 S93505483FFNC S94510483FFNC					FUSE HOLDER 
						480087001 ALL MODELS
SEC. TR (240/24V)	MANUAL RESET	LIMIT	HIGH/LOW SW.	DOOR SW.	FAN AUTO/ON SW.	BLOWER WHEEL
						
490026910 ALL MODELS	4520-2017-000 ALL MODELS	4520-2048-000 ALL MODELS	5216-2029-000 ALL MODELS	5216-2028-000 ALL MODELS	5216-2029-001 ALL MODELS	490047001 ALL MODELS
THERMOSTAT	T'STAT KNOB	PLUG BUTTON				
						
410127001 ALL MODELS	3301-2020-001 ALL MODELS	4506-2012-000 ALL MODELS				



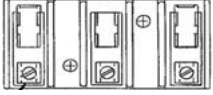



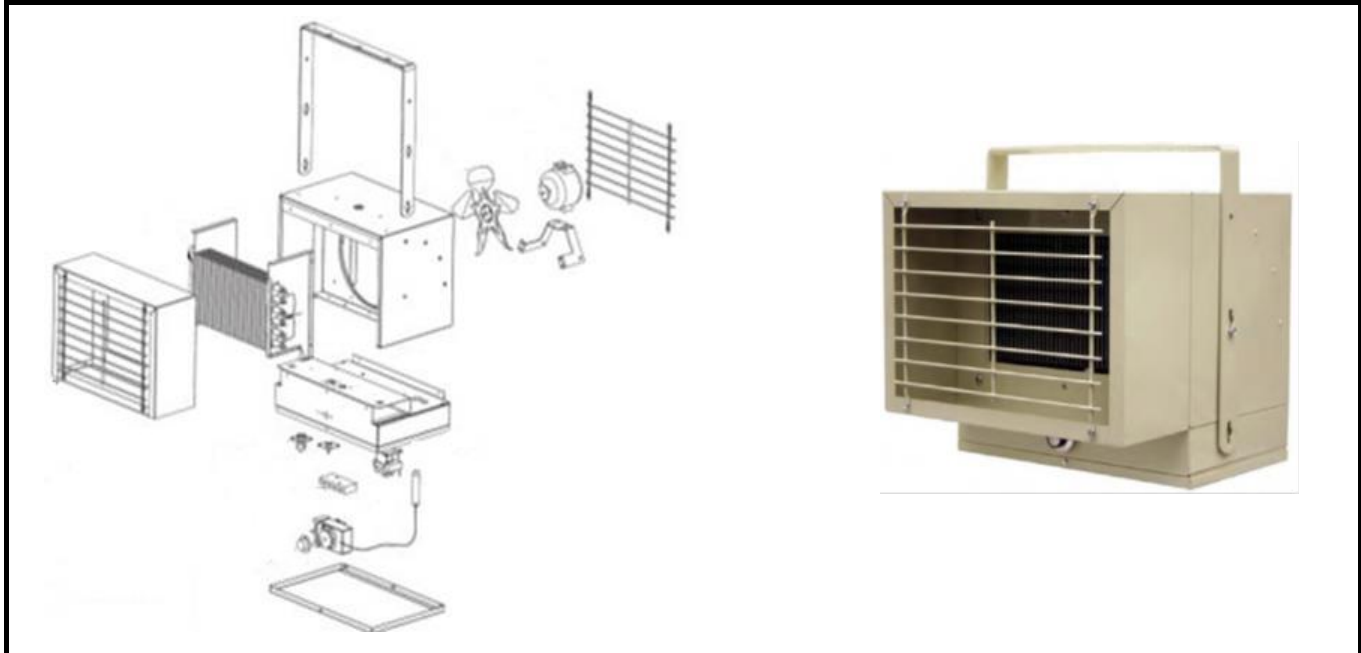





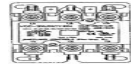



COMPACT FREEZE PROTECTION HEATERS PHFP25











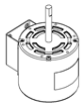
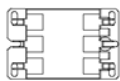
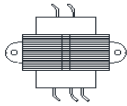

ELEMENT	MOTOR	FAN BLADE	FAN RELAY	RELAY
				
1802-11002-000 PHFP25	3900-11007-001 PHFP25	1210-2017-000 PHFP25	410171003 PHFP25	1414-2038-000 PHFP25
THERMOSTAT	KNOB	HI LIMIT	POWER BLOCK	MT. BRACKET
				
5813-2091-000 PHFP25	3301-2053-000 PHFP25	1414-2037-000 PHFP25	5823-0004-005 PHFP25	310876001 PHFP25

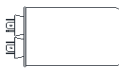
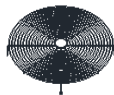
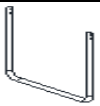
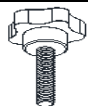

HUH SERIES

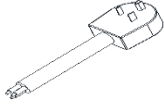
ELEMENT			FAN BLADE		MOTOR		RELAY			
										
302006804 UH520 UH520A	302006811 UH727 UH727A	302006842 UH1534 UH1560	1210-2017-000 UH520 UH520A UH524 UH524A	490011001 UH1020 UH1024 UH1027 UH1034 UH1048 UH1060 UH1520 UH1524 UH1527 UH1534 UH1548 UH1560A UH720 UH720A UH724 UH724A UH727 UH727A UH734 UH734A UH748 UH1060 UH2034 UH2060	3900-2008-000 UH520 UH520A UH524 UH534 UH534A UH538 UH538A UH548 UH548A UH560 UH560A UH720 UH720A UH724 UH724A UH748 UH748A	490059004 UH1020 UH1024 UH1027 UH1034 UH1048 UH1060 UH1520 UH1524 UH1527 UH1534 UH1548 UH1560 UH1560A UH720 UH720A UH724 UH724A UH748 UH748A	5018-0004-102 UH520A UH524A UH538 UH538A UH548 UH548A UH560 UH560A UH720 UH724 UH748 UH748A UH760 UH760A UH1034	5018-0003-002 UH534 UH534A UH734 UH734A UH1534	5018-0005-006 UH1020 UH1024 UH1027 UH1048 UH1060 UH1520 UH1524 UH1527 UH1548 UH1560 UH2034 UH2048 UH2060 UH2548 UH2560 UH3048 UH3060	
302006807 UH524 UH524A UH548 UH548A	302006840 UH734 UH734A UH760 UH760A	302006829 UH2548 302006843 UH2560 302006822 UH3048 302006844 UH3060	UH534 UH534A UH538 UH538A UH548 UH548A UH560 UH560A UH720 UH720A UH724 UH724A UH727 UH727A UH734 UH734A UH748 UH748A UH760 UH760A	UH1020 UH1024 UH1027 UH1034 UH1048 UH1060 UH1520 UH1524 UH1527 UH1534 UH1548 UH1560 UH1560A UH720 UH720A UH724 UH724A UH748 UH748A UH760 UH760A	UH520 UH520A UH524 UH534 UH534A UH538 UH538A UH548 UH548A UH560 UH560A UH720 UH720A UH724 UH724A UH748 UH748A	UH1020 UH1024 UH1027 UH1034 UH1048 UH1060 UH1520 UH1524 UH1527 UH1534 UH1548 UH1560 UH1560A UH720 UH720A UH724 UH724A UH748 UH748A	UH520A UH524A UH538 UH538A UH548 UH548A UH560 UH560A UH720 UH724 UH748 UH748A UH760 UH760A UH1034	UH534 UH534A UH734 UH734A UH1534	UH1020 UH1024 UH1027 UH1048 UH1060 UH1520 UH1524 UH1527 UH1548 UH1560 UH2034 UH2048 UH2060 UH2548 UH2560 UH3048 UH3060	
302006839 UH534 UH534A UH560 UH560A	302006812 UH1020 UH1527 302006813 UH1024 UH1048 UH1520 UH2048	UH3048 UH3060	UH538 UH538A UH548 UH548A UH560 UH560A UH720 UH720A UH724 UH724A UH727 UH727A UH734 UH734A UH748 UH748A UH760 UH760A	UH1020 UH1024 UH1027 UH1034 UH1048 UH1060 UH1520 UH1524 UH1527 UH1534 UH1548 UH1560 UH1560A UH720 UH720A UH724 UH724A UH748 UH748A UH760 UH760A	UH520 UH520A UH524 UH534 UH534A UH538 UH538A UH548 UH548A UH560 UH560A UH720 UH720A UH724 UH724A UH748 UH748A	UH1020 UH1024 UH1027 UH1034 UH1048 UH1060 UH1520 UH1524 UH1527 UH1534 UH1548 UH1560 UH1560A UH720 UH720A UH724 UH724A UH748 UH748A	UH520A UH524A UH538 UH538A UH548 UH548A UH560 UH560A UH720 UH724 UH748 UH748A UH760 UH760A UH1034	UH534 UH534A UH734 UH734A UH1534	UH1020 UH1024 UH1027 UH1048 UH1060 UH1520 UH1524 UH1527 UH1548 UH1560 UH2034 UH2048 UH2060 UH2548 UH2560 UH3048 UH3060	
302006848 UH538 UH538A	UH1048 UH1520 UH2048		UH724 UH727 UH727A UH734 UH734A UH748 UH748A UH760 UH760A	UH1020 UH1024 UH1027 UH1034 UH1048 UH1060 UH1520 UH1524 UH1527 UH1534 UH1548 UH1560 UH1560A UH720 UH720A UH724 UH724A UH748 UH748A UH760 UH760A	UH520 UH520A UH524 UH534 UH534A UH538 UH538A UH548 UH548A UH560 UH560A UH720 UH720A UH724 UH724A UH748 UH748A	UH1020 UH1024 UH1027 UH1034 UH1048 UH1060 UH1520 UH1524 UH1527 UH1534 UH1548 UH1560 UH1560A UH720 UH720A UH724 UH724A UH748 UH748A	UH520A UH524A UH538 UH538A UH548 UH548A UH560 UH560A UH720 UH724 UH748 UH748A UH760 UH760A UH1034	UH534 UH534A UH734 UH734A UH1534	UH1020 UH1024 UH1027 UH1048 UH1060 UH1520 UH1524 UH1527 UH1548 UH1560 UH2034 UH2048 UH2060 UH2548 UH2560 UH3048 UH3060	
302006809 UH720 UH720A	302006814 UH1027 UH1524 UH1548		UH724 UH727 UH727A UH734 UH734A UH748 UH748A UH760 UH760A	UH1020 UH1024 UH1027 UH1034 UH1048 UH1060 UH1520 UH1524 UH1527 UH1534 UH1548 UH1560 UH1560A UH720 UH720A UH724 UH724A UH748 UH748A UH760 UH760A	UH520 UH520A UH524 UH534 UH534A UH538 UH538A UH548 UH548A UH560 UH560A UH720 UH720A UH724 UH724A UH748 UH748A	UH1020 UH1024 UH1027 UH1034 UH1048 UH1060 UH1520 UH1524 UH1527 UH1534 UH1548 UH1560 UH1560A UH720 UH720A UH724 UH724A UH748 UH748A	UH520A UH524A UH538 UH538A UH548 UH548A UH560 UH560A UH720 UH724 UH748 UH748A UH760 UH760A UH1034	UH534 UH534A UH734 UH734A UH1534	UH1020 UH1024 UH1027 UH1048 UH1060 UH1520 UH1524 UH1527 UH1548 UH1560 UH2034 UH2048 UH2060 UH2548 UH2560 UH3048 UH3060	
302006810 UH724 UH724A UH748 UH748A	302006841 UH1034 UH1060 UH2034 UH2060		UH724 UH727 UH727A UH734 UH734A UH748 UH748A UH760 UH760A	UH1020 UH1024 UH1027 UH1034 UH1048 UH1060 UH1520 UH1524 UH1527 UH1534 UH1548 UH1560 UH1560A UH720 UH720A UH724 UH724A UH748 UH748A UH760 UH760A	UH520 UH520A UH524 UH534 UH534A UH538 UH538A UH548 UH548A UH560 UH560A UH720 UH720A UH724 UH724A UH748 UH748A	UH1020 UH1024 UH1027 UH1034 UH1048 UH1060 UH1520 UH1524 UH1527 UH1534 UH1548 UH1560 UH1560A UH720 UH720A UH724 UH724A UH748 UH748A	UH520A UH524A UH538 UH538A UH548 UH548A UH560 UH560A UH720 UH724 UH748 UH748A UH760 UH760A UH1034	UH534 UH534A UH734 UH734A UH1534	UH1020 UH1024 UH1027 UH1048 UH1060 UH1520 UH1524 UH1527 UH1548 UH1560 UH2034 UH2048 UH2060 UH2548 UH2560 UH3048 UH3060	
LIGHT	FUSE BLOCK	FUSE	CAPACITOR	HI LIMIT	FAN DELAY	TRANSFORMER				
										
3510-2017-003 UH524A UH724A	480099002 UH1020 UH1024 UH1520 480099003 UH1520 UH1524 480096000 UH1527 480099001 UH1534 UH2034 2025-0001-000 UH2034	481001003 UH1020 UH1024 UH1520 UH1534 UH2034 481001006 UH1520 UH1524 481001023 UH1527 2019-7002-007 UH2034	1432-0002-003 UH2548 UH2560 UH3048 UH3060	410027000 ALL MODELS	410148000 ALL MODELS	490015017 UH534 UH534A UH734 UH734A 490015014 UH538 UH538A 490056001 UH548 UH548A UH748 UH748A	490015013 UH560 UH560A UH760 UH760A 490015009 UH1027 UH1527 490015019 UH1034 UH1534 UH2034	490015010 UH1048 UH1548 UH2048 490015012 UH1060 UH1560 UH2060 490015008 UH2548 UH3048 490015015 UH2560 UH3060		
QUANTITY 5 & 7.5KW (4) 10 THRU 20KW (6) 25 & 30KW (9)		LOUVER SPRING			POWER BLOCK		THERMOSTAT (ASSEMBLY 1-POLE)			
3503-2004-109 UH520 UH520A UH524 UH524A UH534 UH534A UH538 UH538A UH548 UH548A UH560 UH560A UH720 UH720A UH724 UH724A UH727 UH727A UH734 UH734A UH748 UH748A UH760 UH760A	3503-2004-111 UH1020 UH1024 UH1027 UH1034 UH1048 UH1060 UH1520 UH1524 UH1527 UH1534 UH1548 UH1560 UH1560A UH2034 UH2048 UH2060	3503-2004-112 UH2548 UH2560 UH3048 UH3060	5208-7005-001 ALL MODELS	29214-11621 UH520 UH520A UH524 UH524A UH534 UH534A UH538 UH538A UH548 UH548A UH560 UH560A UH720 UH720A UH724 UH724A UH727 UH727A UH734 UH734A UH748 UH748A UH760 UH760A	310876001 UH520 UH520A UH524 UH524A UH534 UH534A UH538 UH538A UH548 UH548A UH560 UH560A UH720 UH720A UH724 UH724A UH727 UH727A UH734 UH734A UH748 UH748A UH760 UH760A	5823-0004-000 UH520 UH520A UH524 UH524A UH534 UH534A UH538 UH538A UH548 UH548A UH560 UH560A UH720 UH720A UH724 UH724A UH727 UH727A UH734 UH734A UH748 UH748A UH760 UH760A 5823-0004-005 UH734 UH734A	480100001 UH1020 UH1024 UH1027 UH1034 UH1048 UH1060 UH1520 UH1524 UH1527 UH1534 UH1548 UH1560 UH1560A UH2034 UH2048 UH2060 480034002 UH2548 UH2560 UH3048 UH3060	410112000 THERMOSTAT 3301-2020-003 KNOB UHTA2 (ASSEMBLY 2-STAGE) 5813-2087-000 THERMOSTAT 3301-2053-000 KNOB		

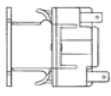
MEDH SERIES

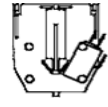
ELEMENT SMALL	ELEMENT LARGE	MOTOR	CONTACTOR	TRANSFORMER	
					
1802-11001-000 DH1583CKD 1802-11001-002 DH1021CKD DH1021D DH1521D DH1523D DH1543CKD DH3043D	1802-11001-001 DH1583CKD 1802-11001-003 DH1021CKD DH1021D DH1521D DH1523D DH1543CKD DH3043D	3900-11002-000 DH1583CKD DH1021CKD DH1021D DH1521D DH1523D 3900-11002-001 DH1543CKD DH3043D	5018-0006-007 DH1583CKD DH1521D DH1523D	5018-0006-009 DH1543CKD DH3043D 5018-0006-010 DH1021CKD	5814-0003-002 DH1543CKD DH3043D
FAN BLADE	HI LIMIT	THERMOSTAT	CAPACITOR	GUARDS QTY.2 NEEDED	
					
1210-0098-001 ALL MODELS	410029000 ALL MODELS	5813-2059-000 ALL MODELS	1432-0002-003 ALL MODELS	2504-11005-000 ALL MODELS	
HANDLE	CART KNOB	THERMOSTAT KNOB	WHEEL	SHAFT CAP	AXEL SHAFT
					
2710-11001-000 ALL MODELS	3301-11003-000 ALL MODELS	3301-11018-002 ALL MODELS	6406-0002-000 ALL MODELS	1408-11002-000 ALL MODELS	5217-11001-000 ALL MODELS
CORD	FUSE	FUSE BLOCK	FAN RELAY	FAN DELAY	AUXILIARY SWITCH
					
SCS25064 DH1583CKD SCS10063 DH1021CKD SCS25124 DH1543CKD	2019-7008-077 DH1521D	480030007 DH1521D	5018-0007-000 DH1543CKD DH3043D	1414-2039-000 DH3043D	5216-10564-000 DH1521D

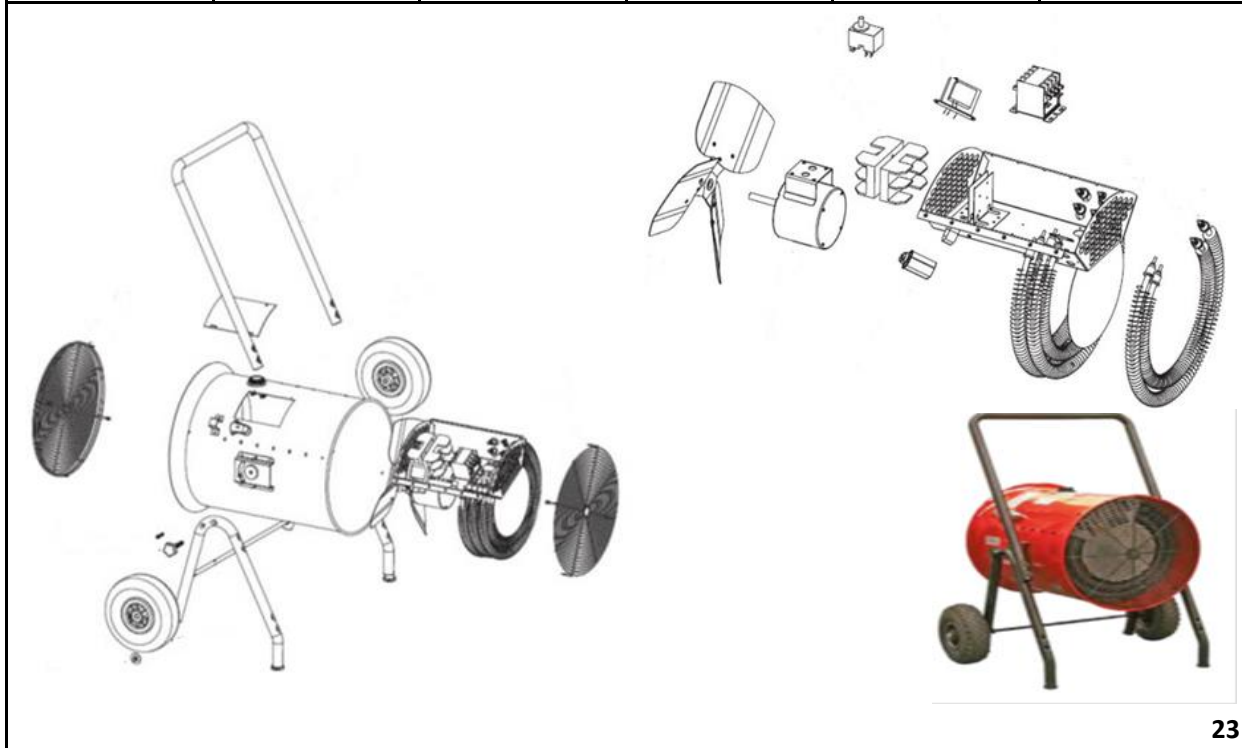

BSDH

MODEL	ELEMENT (11)	ELEMENT (12)	MOTOR (16)	CONTACTOR (20)
SDH3043	118-304793-011 (3)	118-304793-013 (3)	193-121843-232	072-304551-008
SDH3093	118-304793-012 (3)	118-304793-014 (3)	193-121843-233	072-304551-008
SDH4843	118-304793-011 (3)	118-304793-013 (6)	193-121843-232	072-304551-008 (2)
SDH4893	118-304793-012 (3)	118-304793-014 (6)	193-121843-233	072-304551-008 (2)
SDH6043	118-304793-011 (6)	118-304793-013 (6)	193-121843-232	072-304551-008 (2)
SDH6093	118-304793-012 (6)	118-304793-014 (6)	193-121843-233	072-304551-008 (2)
MODEL	TRANSFORMER (21)	FUSE BLOCK (80)	FUSE (81)	TERM. BLOCK (84)
SDH3043	315-304252-001	NA	NA	NA*
SDH3093	315-304252-003	NA	NA	NA*
SDH4843	315-304252-001	129-025643-001	128-026510-005 (3)	303-047468-004
SDH4893	315-304252-003	129-025643-001	128-026510-005 (3)	303-047468-004
SDH6043	315-304252-001	129-025643-001 (2)	128-026510-006 (6)	303-047468-004
SDH6093	315-304252-003	129-025643-001 (2)	128-026510-006 (6)	303-047468-004

PARTS COMMON TO ALL UNITS



TEMPERATURE CONTROL (18)	300-019560-002
HI-LIMIT (19)	300-049200-004
TOGGLE SWITCH (23)	292-046123-001
BLOWER ASSEMBLY (32)	021-304823-009
INLET & OUTLET GRILLE (33)	134-304780-002 (2)
CASTER/LOCKING (36)	375-122535-007
HANDLE-RIGHT SIDE (37)	139-304779-003
HANDLE-LEFT SIDE (38)	139-304479-004
SEMI-PNEUMATIC WHEEL (45)	333-557518-004 (2)
PULLEY VAR. PITCH 7/8" (77)	225-305091-004
PULLEY VAR. PITCH 5/8" (78)	225-305091-003
PULLEY BELT (79)	017-049702-009
PILOT LIGHT-GREEN (86)	213-122066-043
PILOT LIGHT-AMBER (87)	213-122066-042
THERMOSTAT KNOB (94)	169-017949-004

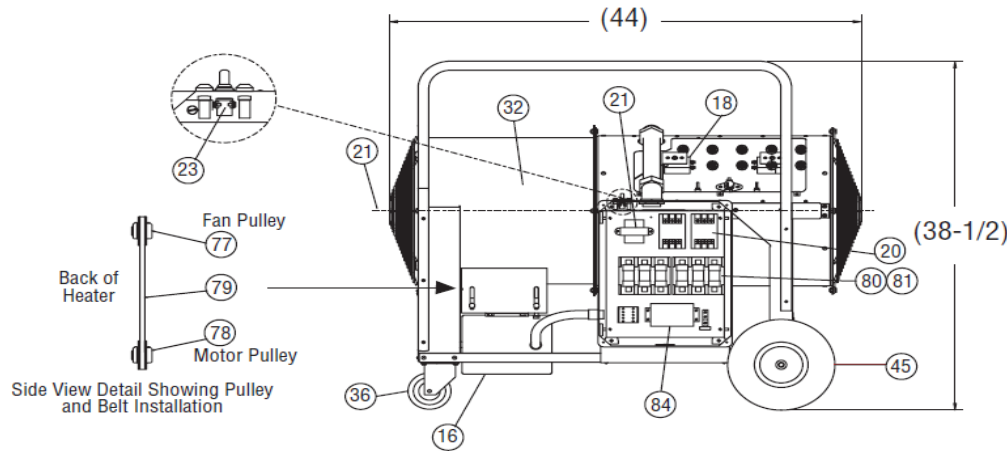
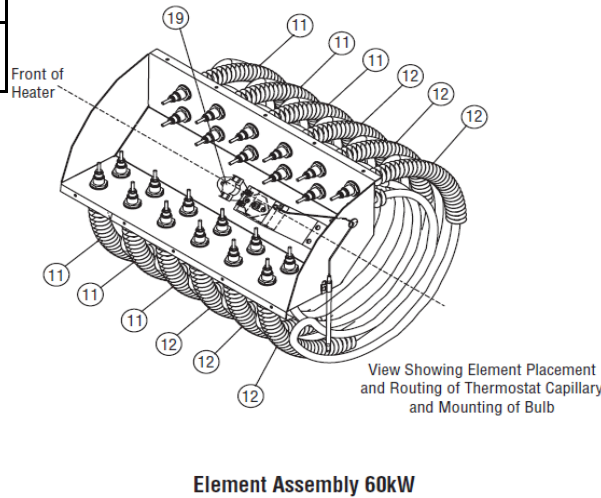
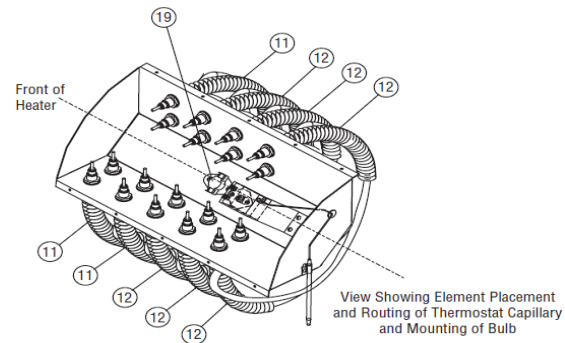
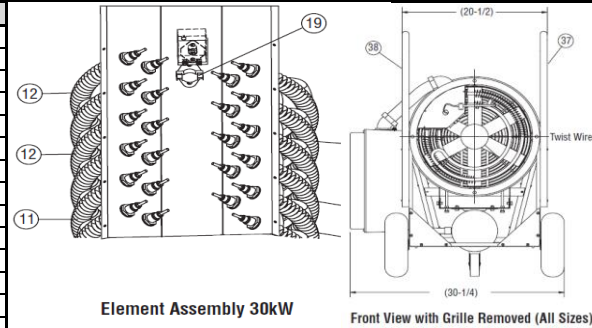



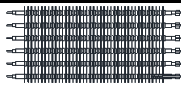
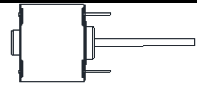
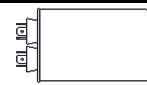

NOTES:
 (#) QUANTITY REQ.
 * WIRED DIRECTLY TO CONTACTOR



BPH PLENUM RATED UNIT HEATER

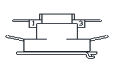
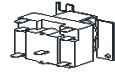

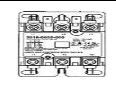

ELEMENT			MOTOR			CAPACITOR		
								
1802-10498-000 PRH1381240000 PRH1383240000	1802-10498-004 PRH11021240000 PRH11023240000 1802-10498-001 PRH152124L000 PRH1521240000 PRH1323240000	1802-10498-007 PRH1343240000 1802-10498-008 PRH11583240000 PRH17581240000 PRH17583240000	3900-10164-001 PRH11043240000 PRH11543240000 PRH1343240000 PRH1543240000	3900-10160-003 PRH11021240000 PRH11023240000 PRH11083240000 PRH11523240000 PRH1583240000	3900-2094-001 PRH1321240000 PRH1323240000 PRH1381240000 PRH1383240000 PRH1521240000 PRH1523240000 PRH1581240000 PRH1583240000	1432-0002-001 PRH11043240000 PRH11071240000 PRH11543240000 PRH1321240000 PRH1323240000 PRH1343240000 PRH1371240000 PRH1381240000 PRH1383240000 PRH1521240000 PRH1523240000		1432-0002-002 PRH1543240000 PRH157124L000 PRH1571240000 PRH1583240000 PRH1583240000 PRH17543240000 PRH17571240000 PRH21043240000 PRH21071240000 PRH21543240000
1802-10498-002 PRH1371240000 PRH21021240000 PRH21023240000	1802-10498-005 PRH11071240000 PRH157124L000 PRH1571240000 PRH21071240000 1802-10498-006 PRH11043240000 PRH154324L000 PRH1543240000 PRH21043240000	1802-10498-009 PRH17521240000 PRH17523240000 PRH17523240000 1802-10498-010 PRH17571240000 1802-10498-011 PRH11543240000 PRH17543240000 PRH21543240000	3900-10162-001 PRH11071240000 PRH157124L000 PRH17571240000 PRH21071240000	3900-2095-001 PRH17521240000 PRH17523240000 PRH17581240000 PRH17583240000 PRH21021240000 PRH21023240000 PRH21083240000 PRH21523240000	PRH11043240000 PRH11071240000 PRH11543240000 PRH1321240000 PRH1323240000 PRH1343240000 PRH1371240000 PRH1381240000 PRH1383240000 PRH1521240000 PRH1523240000 PRH1581240000 PRH1583240000	PRH1543240000 PRH157124L000 PRH1571240000 PRH1583240000 PRH1583240000 PRH17543240000 PRH17571240000 PRH21043240000 PRH21071240000 PRH21543240000	PRH11021240000 PRH11023240000 PRH11083240000 PRH11523240000 PRH11583240000 PRH152124L000 PRH152324L000 PRH158324L000 PRH157124L000 PRH158124L000 PRH158324L000	PRH11021240000 PRH11023240000 PRH11083240000 PRH11523240000 PRH11583240000 PRH152124L000 PRH1523240000 PRH1571240000 PRH1581240000 PRH1583240000

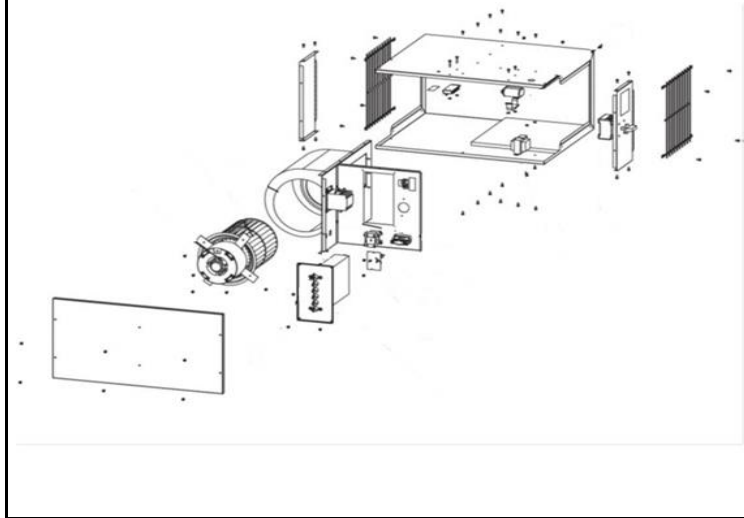
BLOWER ASSEMBLY		LIMIT		GRILLE	
					
1225-10158-000 PRH11021240000 PRH11023240000 PRH11043240000 PRH1071240000 PRH11083240000 PRH11523240000 PRH11543240000 PRH11583240000 PRH152124L000 PRH152324L000 PRH154324L000 PRH157124L000 PRH158124L000 PRH158324L000	1225-2022-000 PRH1321240000 PRH1323240000 PRH1343240000 PRH1071240000 PRH1381240000 PRH1383240000 PRH1521240000 PRH1523240000 PRH1543240000 PRH1571240000 PRH1581240000 PRH1583240000	1414-2040-001 PRH11021240000 PRH11023240000 PRH11043240000 PRH1071240000 PRH11083240000 PRH11523240000 PRH11543240000 PRH11583240000 PRH152124L000 PRH152324L000 PRH154324L000 PRH157124L000 PRH158124L000 PRH158324L000	1414-2040-000 PRH17521240000 PRH17523240000 PRH17543240000 PRH17571240000 PRH17581240000 PRH17583240000 PRH21021240000 PRH21023240000 PRH21043240000 PRH21071240000 PRH21083240000 PRH21523240000 PRH21543240000	2501-10156-800 PRH11021240000 PRH11023240000 PRH11043240000 PRH1071240000 PRH11083240000 PRH11523240000 PRH11543240000 PRH11583240000 PRH152124L000 PRH152324L000 PRH154324L000 PRH157124L000 PRH158124L000 PRH158324L000	312056803 PRH1321240000 PRH1323240000 PRH1343240000 PRH1371240000 PRH1381240000 PRH1383240000 PRH1521240000 PRH1523240000 PRH1543240000 PRH1571240000 PRH1581240000 PRH1583240000

TRANSFORMER		TERMINAL BLOCK		TIME DELAY RELAY	FAN RELAY	DISCONNECT SW.
						
5814-0003-000 PRH11021240000 PRH11023240000 PRH11083240000 PRH11523240000 PRH11583240000 PRH1321240000 PRH1323240000 PRH1381240000 PRH1383240000 PRH152124L000 PRH1521240000 PRH152324L000 PRH154324L000 PRH157124L000 PRH158124L000	5814-0003-001 PRH11071240000 PRH1157124L000 PRH11571240000 PRH17571240000 PRH21071240000 5814-0003-002 PRH11043240000 PRH11543240000 PRH1343240000 PRH154324L000 PRH1543240000 PRH17543240000 PRH21043240000 PRH21543240000	480106001 PRH11021240000 PRH11023240000 PRH11043240000 PRH1071240000 PRH11083240000 PRH11523240000 PRH11543240000 PRH11583240000 PRH1321240000 PRH1323240000 PRH1343240000 PRH1371240000 PRH1381240000 PRH1383240000 PRH152124L000 PRH1521240000	480106002 PRH152324L000 PRH1523240000 PRH154324L000 PRH1543240000 PRH157124L000 PRH1571240000 PRH158124L000 PRH1581240000 PRH158324L000 PRH1583240000 PRH17521240000 PRH17523240000 PRH17543240000 PRH17571240000 PRH17581240000 PRH17583240000	410171001 ALL MODELS CONTACTOR RELAY  5018-0005-004 ALL MODELS	5018-2024-000 ALL MODELS 	5216-2036-000 ALL MODELS





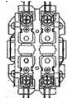
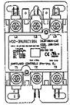
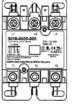
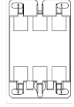
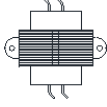





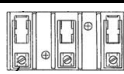

HUHAA SERIES

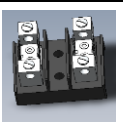
ELEMENT				MOTOR		
QUANTITY OF ELEMENTS 3 THRU 10KW (3) 15 THRU 30KW (6) 40 & 50KW (9)						
1802-0087-024 HUHAA320FC	1802-0087-031 HUHAA720FC HUHAA1024FC	1802-0087-037 HUHAA1524FC HUHAA2024FC	1802-0087-018 HUHAA3024FC 1802-0087-019 HUHAA3048AFC	3900-2002-506 HUHAA320FC HUHAA324FC HUHAA520FC HUHAA524FC	3900-0347-005 HUHAA748FC HUHAA1048FC 3900-0361-500 HUHAA1520FC HUHAA1524FC	3900-0363-500 HUHAA2548AFC HUHAA3048AFC 3900-0350-000 HUHAA5020FC 3900-0350-000 HUHAA4024FC HUHAA5024FC
1802-0087-000 HUHAA324FC	1802-0087-006 HUHAA724FC	1802-0087-012 HUHAA1524FC	1802-0087-020 HUHAA4024FC	3900-2002-507 HUHAA327FC HUHAA527FC	3900-0361-501 HUHAA1548FC	3900-0350-001 HUHAA4048FC HUHAA5048FC
1802-0087-001 HUHAA327FC	1802-0087-007 HUHAA727FC	1802-0087-008 HUHAA1548FC	1802-0087-021 HUHAA4048FC	3900-2005-000 HUHAA348FC HUHAA548FC	3900-0362-002 HUHAA2020FC	
1802-0087-002 HUHAA348FC	1802-0087-008 HUHAA748FC	1802-0087-026 HUHAA2020FC	1802-0087-030 HUHAA5020FC	3900-2014-004 HUHAA720FC HUHAA724FC HUHAA727FC HUHAA1020FC HUHAA1024FC	3900-0362-000 HUHAA2024FC	
1802-0087-034 HUHAA520FC	1802-0087-036 HUHAA1020FC	1802-0087-016 HUHAA2524FC	1802-0087-022 HUHAA5024FC	1802-0087-023 HUHAA5048FC	3900-0362-001 HUHAA2048FC	
1802-0087-035 HUHAA524FC	1802-0087-010 HUHAA1027FC	1802-0087-017 HUHAA2548AFC			3900-0364-000 HUHAA2524FC HUHAA3020FC HUHAA3024FC	
1802-0087-004 HUHAA527FC	1802-0087-011 HUHAA1048FC HUHAA2048FC	1802-0087-028 HUHAA3020FC				
1802-0087-005 HUHAA548FC						
FAN BLADE				PROTECTOR LIMIT		FAN DELAY
						
1210-2000-000 HUHAA320FC HUHAA324FC HUHAA327FC HUHAA348FC HUHAA520FC HUHAA524FC HUHAA527FC HUHAA548FC	1210-0090-000 HUHAA720FC HUHAA724FC HUHAA727FC HUHAA748FC HUHAA1020FC HUHAA1024FC HUHAA1027FC HUHAA1048FC 1210-0090-001 HUHAA1520FC HUHAA1524FC HUHAA1548FC 1210-0096-000 HUHAA2020FC HUHAA2024FC HUHAA2048FC	1210-0098-000 HUHAA2524FC HUHAA2548AFC HUHAA3020FC HUHAA3024FC HUHAA3048AFC 1210-11004-000 HUHAA4024FC HUHAA4048FC HUHAA5020FC HUHAA5024FC HUHAA5048FC	4520-0011-000 HUHAA320FC HUHAA324FC HUHAA327FC HUHAA348FC HUHAA520FC HUHAA524FC HUHAA527FC HUHAA548FC	4520-0011-001 HUHAA720FC HUHAA724FC HUHAA727FC HUHAA748FC HUHAA1020FC HUHAA1024FC HUHAA1027FC HUHAA1048FC HUHAA1520FC HUHAA1524FC HUHAA1548FC HUHAA2020FC HUHAA2024FC HUHAA2048FC	4520-0011-002 HUHAA2524FC HUHAA2548AFC HUHAA3020FC HUHAA3024FC HUHAA3048AFC HUHAA4024FC HUHAA4048FC HUHAA5020FC HUHAA5024FC HUHAA5048FC	4520-0010-000 ALL MODELS
RELAY				POWER TR		
						
30 AMP 5018-0003-000 HUHAA727FC HUHAA1027FC	35 AMP 5018-0004-100 HUHAA348FC HUHAA548FC HUHAA748FC HUHAA1048FC HUHAA1548FC	40 AMP 5018-0005-004 HUHAA724FC HUHAA720FC HUHAA1024FC HUHAA1020FC HUHAA1524FC HUHAA1520FC HUHAA2048FC HUHAA2020FC HUHAA2524FC HUHAA2548AFC HUHAA3024FC HUHAA3048AFC HUHAA4024FC HUHAA4048FC HUHAA5024FC	50 AMP 5018-0006-000 HUHAA2024FC HUHAA3020FC HUHAA5020FC HUHAA5048FC 40 AMP 5018-11562-004 HUHAA4024FC HUHAA5024FC HUHAA5020FC	240/208V PR TO 24V SEC 5814-0003-000 HUHAA720FC HUHAA724FC HUHAA1020FC HUHAA1024FC HUHAA1520FC HUHAA1524FC HUHAA2020FC HUHAA2024FC HUHAA2524FC HUHAA3020FC HUHAA3024FC 277V PR TO 24V SEC 5814-0003-001 HUHAA727FC HUHAA1027FC	480V PR TO 24V SEC 5814-0003-002 HUHAA348FC HUHAA548FC HUHAA748FC HUHAA1048FC HUHAA1548FC HUHAA2048FC HUHAA2548AFC HUHAA3048AFC HUHAA4048FC HUHAA5048FC	240V/208V PR TO 24V SEC 490026007 HUHAA4024FC HUHAA5020FC HUHAA5024FC

PRO AND PRO-SSP CONTINUE NEXT PAGE

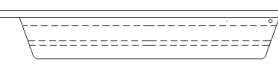



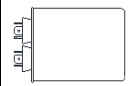





HUHAA CONTINUED

CONTROL BOARD		POWER BLOCK		FUSE BLOCK	FUSE
					
5823-0001-000 HUHAA320FC HUHAA324FC HUHAA327FC HUHAA520FC HUHAA524FC HUHAA527FC	5823-0002-000 HUHAA348FC HUHAA548FC HUHAA724FC HUHAA727FC HUHAA748FC HUHAA1020FC HUHAA1024FC HUHAA1027FC HUHAA1048FC HUHAA1520FC HUHAA1524FC HUHAA1548FC	5823-0004-000 HUHAA320FC HUHAA324FC HUHAA327FC HUHAA348FC HUHAA520FC HUHAA524FC HUHAA527FC HUHAA548FC HUHAA720FC	5823-0004-001 HUHAA724FC HUHAA727FC HUHAA748FC HUHAA1020FC HUHAA1024FC HUHAA1027FC HUHAA1048FC HUHAA1548FC HUHAA2048FC	2025-0002-000 HUHAA1520FC HUHAA2020FC 480030004 HUHAA2524FC HUHAA3020FC HUHAA3024FC HUHAA4024FC HUHAA5020FC HUHAA5024FC	2019-0007-010 HUHAA1520FC 2019-0007-008 HUHAA2020FC 2019-7008-077 HUHAA2524FC 2019-7008-080 HUHAA3020FC HUHAA5020FC 2019-7008-079 HUHAA3024FC HUHAA5024FC 2019-7008-078 HUHAA4024FC 2019-7002-008 HUHAA5048FC 2019-7002-012 HUHAA5048FC
				5823-0004-003 HUHAA1520FC HUHAA3024FC	2025-0001-000 HUHAA5048FC
		7.5-10KW 208 & 240V MODELS AFTER JAN 2024 5823-11012-000		5823-0005-000 HUHAA3020FC HUHAA4024FC HUHAA5020FC HUHAA5024FC	

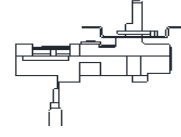
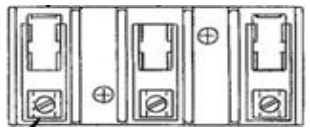
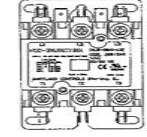
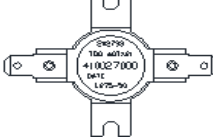
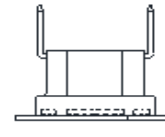









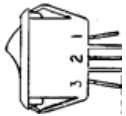

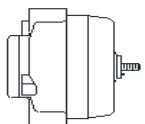
LOUVERS			LOUVER SPRING	HI/LOW SW.	CAPACITOR	
QUANTITY 38.5KW (5) 7 THRU 20KW (6) 25 THRU 50KW (9)						
3503-2004-106 HUHAA320FC HUHAA324FC HUHAA327FC HUHAA348FC HUHAA520FC HUHAA524FC HUHAA527FC HUHAA548FC	3503-2004-107 HUHAA720FC HUHAA724FC HUHAA727FC HUHAA748FC HUHAA1020FC HUHAA1024FC HUHAA1027FC HUHAA1048FC HUHAA1520FC HUHAA1524FC HUHAA1548FC HUHAA2020FC HUHAA2024FC HUHAA2048FC	3503-2004-108 HUHAA2524FC HUHAA2548AFC HUHAA3020FC HUHAA3024FC HUHAA3048AFC HUHAA4024FC HUHAA4048FC HUHAA5020FC HUHAA5024FC HUHAA5048FC	5208-7005-001 ALL MODELS	5216-2053-000 HUHAA2524FC HUHAA2548AFC HUHAA3020FC HUHAA3024FC HUHAA3048AFC HUHAA4024FC HUHAA4048FC HUHAA5020FC HUHAA5024FC HUHAA5048FC	1432-0002-003 HUHAA2020FC HUHAA2024FC HUHAA2048FC HUHAA2524FC 1432-11004-000 HUHAA2548AFC HUHAA3048AFC 1432-0002-001 HUHAA3020FC 1432-0002-004 HUHAA4024FC HUHAA4048FC HUHAA5020FC HUHAA5024FC HUHAA5048FC	THERMOSTAT (ASSM INCLUDES KNOB) UHMT1 (ASSEMBLY 1-POLE) 5813-0036-000 THERMOSTAT 3301-2020-006 KNOB UHMT2 (ASSEMBLY 2-STAGE) 5813-0035-000 THERMOSTAT 3301-2020-006 KNOB UHMT1-S (ASSEMBLY 1-POLE) 5813-0038-003 THERMOSTAT 3301-2020-006 KNOB

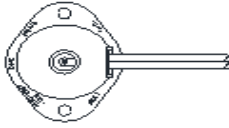
HUHAA PRO SERIES				
SAME PARTS AS STOCK MODELS WITH ADDED DISCONNECT SWITCH, THERMOSTAT, & 24V CONTROL CIRCUIT				
MODEL	DISCONNTEC SWITCH	THERMOSTAT	TRANSFORMER	RELAY
HUHAA320FC-PRO	5216-2036-000	UHMT1	5814-0003-000	5018-0003-000
HUHAA324FC-PRO	5216-2036-000	UHMT1	5814-0003-000	5018-0003-000
HUHAA348FC-PRO	5216-2036-000	UHMT1	5814-0003-002	5018-0004-100
HUHAA520FC-PRO	5216-2036-000	UHMT1	5814-0003-000	5018-0003-000
HUHAA524FC-PRO	5216-2036-000	UHMT1	5814-0003-000	5018-0003-000
HUHAA548FC-PRO	5216-2036-000	UHMT1	5814-0003-002	5018-0004-100
HUHAA720FC-PRO	5216-2039-000	UHMT1	5814-0003-000	5018-0003-000
HUHAA724FC-PRO	5216-2039-000	UHMT1	5814-0003-000	5018-0003-000
HUHAA748FC-PRO	5216-2036-000	UHMT1	5814-0003-002	5018-0004-100
HUHAA1020FC-PRO	5216-2039-000	UHMT1	5814-0003-000	5018-0004-100
HUHAA1024FC-PRO	5216-2039-000	UHMT1	5814-0003-000	5018-0003-000
HUHAA1048FC-PRO	5216-2036-000	UHMT1	5814-0003-002	5018-0004-100
MODEL	DISCONNTEC SWITCH	THERMOSTAT	TRANSFORMER	RELAY
HUHAA320FCPRSS	5216-2036-000	1414-11050-000	5814-0003-000	5018-0003-000
HUHAA324FCPRSS	5216-2036-000	1414-11050-000	5814-0003-000	5018-0003-000
HUHAA348FCPRSS	5216-2036-000	1414-11050-000	5814-0003-002	5018-0004-100
HUHAA520FCPRSS	5216-2036-000	1414-11050-000	5814-0003-000	5018-0003-000
HUHAA524FCPRSS	5216-2036-000	1414-11050-000	5814-0003-000	5018-0003-000
HUHAA548FCPRSS	5216-2036-000	1414-11050-000	5814-0003-002	5018-0004-100
HUHAA720FCPRSS	5216-2039-000	1414-11050-000	5814-0003-000	5018-0003-000
HUHAA724FCPRSS	5216-2039-000	1414-11050-000	5814-0003-000	5018-0003-000
HUHAA748FCPRSS	5216-2036-000	1414-11050-000	5814-0003-002	5018-0004-100
HUHAA1020FCPRSS	5216-2039-000	1414-11050-000	5814-0003-000	5018-0004-100
HUHAA1024FCPRSS	5216-2039-000	1414-11050-000	5814-0003-000	5018-0003-000
HUHAA1048FCPRSS	5216-2036-000	1414-11050-000	5814-0003-002	5018-0004-100

HUH524TA & HUH724ST SERIES

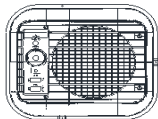
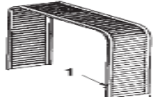
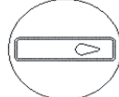
ELEMENT		MOTOR	FAN BLADE	KNOB	THERMOSTAT
					
302006807 HUH524TA HUH524TAB HUH524TAC	302006810 UH724ST UH724STA	3900-2008-000 HUH524TA HUH524TAB HUH524TAC UH724ST UH724STA	1210-2017-000 HUH524TA HUH524TAB HUH524TAC UH724ST UH724STA	3301-2014-006 HUH524TA HUH524TAB HUH524TAC UH724ST UH724STA	5813-2050-000 HUH524TA HUH524TAB HUH524TAC UH724ST UH724STA
POWER BLOCK		RELAY	HI LIMIT	FAN DELAY	LIGHT
					
5823-0004-005 HUH524TA HUH524TAB HUH524TAC	5823-0004-000 UH724ST UH724STA	5018-11006-000 UH724ST UH724STA	410027000 HUH524TA HUH524TAB HUH524TAC UH724ST UH724STA	410148000 HUH524TA HUH524TAB HUH524TAC UH724ST UH724STA	3510-2017-003 HUH524TAC UH724STA
LOUVERS		LOUVER SPRING	MT. BRACKET		
					
3503-2004-109 HUH524TA HUH524TAB HUH524TAC	UH724ST UH724STA	5208-7005-001 HUH524TA HUH524TAB HUH524TAC UH724ST UH724STA	310876001 HUH524TA HUH524TAB HUH524TAC UH724ST UH724STA		
					

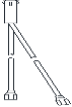
QPH4A & PH5 SERIES

ROCKER SWITCH (2 REQ)		FAN BLADE		ELEMENT (3 REQ)		MOTOR					
											
S99814893A000 PH5 PH5HW PH5HWA PH5HWAB PH5HWAC PH5HWAD PH4A PH4AB NPH4AB NPH4ABA		1210-2000-000 PH5 PH5HW PH5HWA PH5HWAB PH5HWAC PH5HWAD PH4 PH4A		1210-2000-001 PH4AB NPH4AB NPH4ABA		1802-0087-032 PH5 PH5HW PH5HWA PH5HWAB PH5HWAC PH5HWAD	1802-0087-038 PH4 PH4A PH4AB NPH4AB NPH4ABA	3900-2002-506 PH5 PH5HW PH5HWA PH5HWAB PH5HWAC PH5HWAD PH4 PH4A PH4AB NPH4AB NPH4ABA			
FAN DELAY		MANUAL RESET		LIMIT		BUZZER					
											
4520-0010-000 PH5HWAC PH5HWAD		4520-2017-000 PH5HWA PH5HWAB PH4A		4520-11004-000 PH4AB NPH4AB		4520-11004-002 PH5HWAC PH5HWAD NPH4ABA	4520-0011-000 PH5 PH5HW PH4	2714-11001-000 PH5HWAD			
STAND		CONTROL COVER		GRILLE		GUARD		T'STAT KNOB	STAND KNOB (2 REQ)		
											
5210-2000-002 PH5HWAB PH5HWAC PH5HWAD PH4A PH4AB NPH4AB NPH4ABA		1402-0336-000 PH5 PH5HW PH5HWA PH5HWAB PH5HWAC PH5HWAD PH4 PH4AB NPH4AB NPH4ABA		1402-2154-001 PH5HWAB PH5HWAC PH5HWAD PH4AB NPH4AB NPH4ABA		2504-0011-001 PH5 PH5HW PH5HWA PH5HWAB PH5HWAC PH5HWAD PH4 PH4AB NPH4AB NPH4ABA		3301-2012-001 PH5HWAB PH5HWAC PH5HWAD PH4AB NPH4AB NPH4ABA		3301-2018-000 PH5HWA PH5HWAB PH5HWAC PH5HWAD PH4AB NPH4AB NPH4ABA	
LIGHT		CORD		THERMOSTAT							
											
3510-2007-000 PH5HWA PH5HWAB PH5HWAC PH5HWAD		1420-2028-000 PH4AB 1420-11012-000 NPH4AB NPH4ABA		5813-2018-000 PH5HWA PH5HWAB PH5HWAC PH5HWAD PH4A PH4AB NPH4AB NPH4ABA		5813-0047-000 PH5 PH5HW PH4					

WD SERIES WASHDOWN UNIT HEATER

MOTOR		BLADE		ELEMENT	
				QUANTITY REQ 2KW (2) 3 THRU 15KW (3) 20 THRU 39KW (6)	
208-240/480V 2KW-10KW MODELS 277V 3KW-10KW MODELS 120V 2-3KW MODELS 208-240/480V 12.5KW-39KW MODELS		10KW MODELS 10KW MODELS WITH EPOXY COATING 2-7.5KW MODELS 12.5KW MODELS 15-39KW MODELS 12.5KW MODELS WITH EPOXY COATING 15-39KW MODELS WITH EPOXY COATING		2-3KW 120V 2-3KW 208V 2-3KW 240V 3KW 277V 3KW 480V 5KW 208V 5KW 240V 5KW 277V 5KW 480V 3PH 5KW 480V 1PH 7.5KW 208V 7.5KW 240V 7.5KW 277V 7.5KW 480V	
LIMIT 2-10KW 12.5-39KW		HAT BRACKET 2-10KW MODELS 12.5-39KW MODELS		1802-11012-001 1802-11012-002 1802-11012-003 1802-11012-004 1802-11012-005 1802-11012-006 1802-11012-007 1802-11012-007 1802-11012-008 1802-11012-011 1802-11012-012 1802-11012-009 1802-11012-008	
WALL/CEILING BRK 2-10KW MODELS 12.5-39KW MODELS		1016-11218-000 1016-11218-001		10KW 208V 10KW 240V 10KW 277V 10KW 480V 12.5KW 208V 12.5KW 240V 15KW 208V 15KW 240V 20KW 240V 25KW 208V 30KW 240V 15 & 30KW 480V 20KW 480V 39KW 480V	

FAN RELAY			CONTACTOR 50A			TRANSFORMER	
5018-11005-000			5018-11005-001			5018-0006-000	
BWD02112	BWD07812	BWD25232	BWD05431	BWD02112	BWD07812	BWD25432	BWD05431
BWD02212	BWD07832	BWD25432	BWD07831	BWD02212	BWD07832	BWD25432	BWD07831
BWD02812	BWD10112	BWD25832	BWD30431	BWD02812	BWD10112	BWD25832	BWD30431
BWD03112	BWD10232	BWD30232		BWD03112	BWD10232	BWD30232	
BWD03212	BWD10412	BWD30432		BWD03212	BWD10412	BWD30432	
BWD03232	BWD10432	BWD30832		BWD03232	BWD10432	BWD30832	
BWD03432	BWD10712	BWD39432		BWD03432	BWD10712	BWD39432	
BWD03712	BWD10832			BWD03712	BWD10832		
BWD03812	BWD12212			BWD03812	BWD12212		
BWD03832	BWD12232			BWD03832	BWD12232		
BWD05212	BWD12432			BWD05212	BWD12432		
BWD05232	BWD12812			BWD05232	BWD12812		
BWD05412	BWD12832			BWD05412	BWD12832		
BWD05432	BWD15212			BWD05432	BWD15212		
BWD05712	BWD15332			BWD05712	BWD15332		
BWD05812	BWD15412			BWD05812	BWD15412		
BWD05832	BWD15432			BWD05832	BWD15432		
BWD07212	BWD15812			BWD07212	BWD15812		
BWD07232	BWD15832			BWD07232	BWD15832		
BWD07412	BWD20232			BWD07412	BWD20232		
BWD07432	BWD20412			BWD07432	BWD20412		
BWD07712	BWD20432			BWD07712	BWD20432		

GRILLE INLET		GRILLE OUTLET		STRAIGHT FITTING		SILICONE SEAL	
2-10KW MODELS 12.5-39KW MODELS		2-10KW MODELS 12.5-39KW MODELS		2504-11019-001 2504-11021-001		PICTURE NOT AVAILABLE	
2504-11018-000 2504-11020-000				1213-2009-000 ALL MODELS		5250-2001-000 ALL MODELS	

CAPACITOR			POWER BLOCK		
1432-0002-001			1432-0002-003		
BWD02112	BWD05812	BWD12212	BWD03712	BWD20232	BWD02112
BWD02212	BWD05832	BWD12232	BWD03712	BWD20432	BWD02212
BWD02812	BWD07212	BWD12432	BWD03712	BWD20432	BWD02812
BWD03112	BWD07232	BWD12812	BWD03712	BWD20432	BWD03112
BWD03212	BWD07412	BWD12832	BWD03712	BWD20432	BWD03212
BWD03232	BWD07432	BWD15212	BWD03712	BWD20432	BWD03232
BWD03432	BWD07812	BWD15232	BWD03712	BWD20432	BWD03432
BWD03812	BWD07832	BWD15412	BWD03712	BWD20432	BWD03812
BWD03832	BWD10212	BWD15432	BWD03712	BWD20432	BWD03832
BWD05212	BWD10232	BWD15812	BWD03712	BWD20432	BWD05212
BWD05232	BWD10412	BWD15832	BWD03712	BWD20432	BWD05232
BWD05412	BWD10432		BWD03712	BWD20432	BWD05412
BWD05432	BWD10832		BWD03712	BWD20432	BWD05432







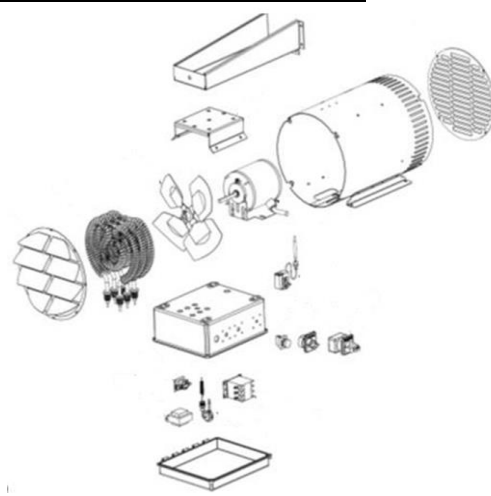

1432-0002-001		1432-0002-003		1432-0002-004		5823-0004-002		480034002	
BWD02112	BWD05812	BWD12212	BWD03712	BWD20232	BWD02112	BWD07712	BWD02112	BWD12212	BWD12812
BWD02212	BWD05832	BWD12232	BWD03712	BWD20432	BWD02212	BWD07832	BWD02212	BWD12812	BWD15212
BWD02812	BWD07212	BWD12432	BWD03712	BWD20432	BWD02812	BWD07832	BWD02812	BWD15212	BWD15812
BWD03112	BWD07232	BWD12812	BWD03712	BWD20432	BWD03112	BWD10212	BWD03112	BWD15812	BWD20232
BWD03212	BWD07412	BWD12832	BWD03712	BWD20432	BWD03212	BWD10232	BWD03212	BWD20232	BWD25232
BWD03232	BWD07432	BWD15212	BWD03712	BWD20432	BWD03232	BWD10412	BWD03232	BWD25232	BWD25832
BWD03432	BWD07812	BWD15232	BWD03712	BWD20432	BWD03432	BWD10432	BWD03432	BWD25832	BWD30232
BWD03812	BWD07832	BWD15412	BWD03712	BWD20432	BWD03712	BWD10712	BWD03712	BWD30232	BWD30832
BWD03832	BWD10212	BWD15432	BWD03712	BWD20432	BWD03812	BWD10832	BWD03812		
BWD05212	BWD10232	BWD15812	BWD03712	BWD20432	BWD03832	BWD12232	BWD03832		
BWD05232	BWD10412	BWD15832	BWD03712	BWD20432	BWD05212	BWD12432	BWD05212		
BWD05412	BWD10432		BWD03712	BWD20432	BWD05232	BWD12832	BWD05232		
BWD05432	BWD10832		BWD03712	BWD20432	BWD05412	BWD15232	BWD05412		
			BWD03712	BWD20432	BWD05432	BWD15412	BWD05432		
			BWD03712	BWD20432	BWD05712	BWD15432	BWD05712		
			BWD03712	BWD20432	BWD05812	BWD15832	BWD05812		
			BWD03712	BWD20432	BWD05832	BWD20412	BWD05832		
			BWD03712	BWD20432	BWD07212	BWD20432	BWD07212		
			BWD03712	BWD20432	BWD07232	BWD25432	BWD07232		
			BWD03712	BWD20432	BWD07412	BWD30432	BWD07412		
			BWD03712	BWD20432	BWD07432	BWD39432	BWD07432		

PART		GASKET		KNOB	
THERMOSTAT		5206-11009-000		3301-11010-000	
SM/MD UNITS		5206-11010-000			
Lrg UNITS					
PILOT LIGHT		N/A		N/A	
120V CONTROL		3510-11009-001			
24V CONTROL		3510-11009-000			
MODE SWITCH		5216-11016-000		PART OF SW. ASSM	
SM/MD UNITS		5216-11016-000			
Lrg UNITS					
DISCONNECT SWITCH		5216-11017-000		PART OF SW. ASSM	
40AMP		5216-11017-001			
60AMP		5216-11017-002			
100AMP		5216-11017-003			
125AMP		5216-11017-003			
MANUAL RESET		N/A		N/A	
SM/MD UNITS					
Lrg UNITS					
EPOXY COATING		4520-11017-001			
CONTACT FACTORY					

Factory Installed Accessories

CATALOG NUMBER	DESCRIPTION
T	Thermostat
L	Pilot Light
S	Mode/Selector Switch
D	Disconnect Switch
E	Monel Element*
M	Manual Reset
P	Epoxy Coating



UCJ														
ELEMENT				LINEAR LIMIT			TR. RELAY							
														
1802-11021-003 J400B	1802-2044-011 J750B	1802-2044-014 J1007B	1802-2044-228 J1503B	4520-2018-000 J400B	4520-2018-003 J1000B	4520-2018-005 J1500B	5018-11003-003 J503B	410043007 J1006B						
1802-11021-001 J404B	1802-2044-210 J753B	1802-2044-016 J1008B	1802-2044-027 J1504B	J404B	J1003B	J1503B	J753B	J1256B						
1802-11021-000 J407B	1802-2044-009 J754B	1802-2044-023 J1250B	1802-2044-229 J1506B	J407B	J1004B	J1504B	J1003B	J1506B						
1802-11021-002 J408B	1802-2044-008 J757B	1802-2044-222 J1253B	1802-2044-026 J1507B	J408B	J1006B	J1506B	J1253B	J2006B						
1802-2044-043 J500B	1802-2044-010 J758B	1802-2044-021 J1254B	1802-2044-028 J1508B	4520-2018-001 J500B	J1007B	J1507B	J1503B							
1802-2044-202 J503B	1802-2044-017 J1000B	1802-2044-223 J1256B	1802-2044-234 J2003B	J503B	4520-2018-004 J1250B	4520-2018-006 J2003B	J2003B							
1802-2044-041 J504B	1802-2044-216 J1003B	1802-2044-020 J1257B	1802-2044-033 J2004B	J507B	J1253B	J2004B	J2004B							
1802-2044-040 J507B	1802-2044-015 J1004B	1802-2044-022 J1258B	1802-2044-235 J2006B	J508B	J1254B	J2006B	J2006B							
1802-2044-042 J508B	1802-2044-217 J1006B	1802-2044-029 J1500B	1802-2044-032 J2007B	4520-2018-002 J750B	J1256B	J2007B	J2007B							
			1802-2044-034 J2008B	J753B	J1257B	J2008B	J2008B							
				J754B	J1258B									
				J757B										
				J758B										
SWITCH		FRONT COVER			CONTROL COVER	THERMOSTAT								
														
5216-11007-000 J400B J1007B J404B J1008B J407B J1250B J408B J1254B J500B J1257B J504B J1258B J507B J1500B J508B J1504B J750B J1507B J754B J1508B J757B J2004B J758B J2007B J1000B J2008B J1004B		5216-2053-000 J503B J753B J1003B J1006B J1253B J1256B J1503B J1506B J2003B J2006B			1402-2192-006 J400B J404B J407B J408B 1402-2192-001 J500B J503B J504B J507B J508B 1402-2192-002 J750B J753B J754B J757B J758B		1402-2192-003 J1000B J1003B J1004B J1006B J1007B J1008B 1402-2192-004 J1250B J1253B J1254B J1256B J1257B J1258B		1402-2192-005 J1500B J1503B J1504B J1506B J1507B J1508B 1402-2192-007 J2003B J2004B J2006B J2007B J2008B		1402-11020-000 ALL MODELS		5813-11014-000 ALL MODELS	
														

ASL SERIES



DISCRIPTION	PART NUMBERS					
	120V	208V	240V	277V	347V	600V
*ELEMENT (100 WATTS/FT)						
28" HEATER	1802-2001-047	1802-2001-048	1802-2001-049	NA	NA	NA
3'	1802-2001-053	1802-2001-054	1802-2001-055	1802-2001-056	NA	NA
4'	1802-2001-059	1802-2001-060	1802-2001-061	1802-2001-062	1802-2001-232	NA
5'	1802-2001-065	1802-2001-066	1802-2001-067	1802-2001-068	1802-2001-242	NA
6'	1802-2001-071	1802-2001-072	1802-2001-073	1802-2001-074	1802-2001-252	1802-2001-253
8'	NA	1802-2001-077	1802-2001-078	1802-2001-079	1802-2001-262	1802-2001-263
10'	NA	1802-2001-081	1802-2001-082	1802-2001-083	1802-2001-272	1802-2001-273
*ELEMENT (125 WATTS/FT)						
28" HEATER	1802-2001-085	1802-2001-086	1802-2001-048	1802-2001-049	NA	NA
3'	1802-2001-087	1802-2001-088	1802-2001-054	1802-2001-055	1802-2001-220	NA
4'	1802-2001-089	1802-2001-090	1802-2001-060	1802-2001-061	1802-2001-230	NA
5'	1802-2001-091	1802-2001-092	1802-2001-066	1802-2001-067	1802-2001-240	1802-2001-241
6'	1802-2001-093	1802-2001-094	1802-2001-072	1802-2001-073	1802-2001-250	1802-2001-251
8'	NA	1802-2001-095	1802-2001-077	1802-2001-078	1802-2001-260	1802-2001-261
10'	NA	1802-2001-096	1802-2001-081	1802-2001-082	1802-2001-270	1802-2001-271
*ELEMENT (150 WATTS/FT)						
28" HEATER	1802-2001-051	1802-2001-001	1802-2001-000	1802-2001-052	NA	NA
3'	1802-2001-057	1802-2001-007	1802-2001-006	1802-2001-058	1802-2001-218	NA
4'	1802-2001-063	1802-2001-013	1802-2001-012	1802-2001-064	1802-2001-228	NA
5'	1802-2001-069	1802-2001-019	1802-2001-018	1802-2001-070	1802-2001-238	1802-2001-239
6'	1802-2001-075	1802-2001-025	1802-2001-024	1802-2001-076	1802-2001-248	1802-2001-249
8'	NA	1802-2001-031	1802-2001-030	1802-2001-080	1802-2001-258	1802-2001-259
10'	NA	1802-2001-035	1802-2001-034	1802-2001-084	1802-2001-268	1802-2001-269
*ELEMENT (188 WATTS/FT)						
28" HEATER	1802-2001-005	1802-2001-002	1802-2001-001	1802-2001-000	NA	NA
3'	1802-2001-011	1802-2001-008	1802-2001-007	1802-2001-006	1802-2001-216	NA
4'	1802-2001-017	1802-2001-014	1802-2001-013	1802-2001-012	1802-2001-226	1802-2001-227
5'	1802-2001-023	1802-2001-020	1802-2001-019	1802-2001-018	1802-2001-236	1802-2001-237
6'	1802-2001-029	1802-2001-026	1802-2001-025	1802-2001-024	1802-2001-246	1802-2001-247
8'	NA	1802-2001-032	1802-2001-031	1802-2001-030	1802-2001-256	1802-2001-257
10'	NA	1802-2001-036	1802-2001-035	1802-2001-034	1802-2001-266	1802-2001-267
*ELEMENT (250 WATTS/FT)						
28" HEATER	1802-2001-004	1802-2001-003	1802-2001-002	1802-2001-001	1802-2001-202	NA
3'	1802-2001-010	1802-2001-009	1802-2001-008	1802-2001-007	1802-2001-214	NA
4'	1802-2001-016	1802-2001-015	1802-2001-014	1802-2001-013	1802-2001-224	1802-2001-225
5'	1802-2001-022	1802-2001-021	1802-2001-020	1802-2001-019	1802-2001-234	1802-2001-235
6'	1802-2001-028	1802-2001-027	1802-2001-026	1802-2001-025	1802-2001-244	1802-2001-245
8'	NA	1802-2001-033	1802-2001-032	1802-2001-031	1802-2001-254	1802-2001-255
10'	NA	1802-2001-037	1802-2001-036	1802-2001-035	1802-2001-264	1802-2001-265
<p>* 1, 2 OR 3 ELEMENTS MAY BE REQUIRED. VOLTAGE AND WATTAGE ARE STAMPED ON END OF ELEMENTS. DIVIDE THE WATTAGE BY THE HEATER LENGTH (FEET) TO DETERMINE WATTS/FOOT OF ELEMENT. THEN USE THIS DATA TO DETERMINE PART NUMBER OF HEATING ELEMENT.</p>						

DISCRIPTION	PART NUMBERS					
	120V	208V	240V	277V	347V	600V
LINEAR LIMIT						
28" HEATER	4520-0007-007	4520-0007-007	4520-0007-007	4520-0007-007	4520-0007-007	4520-0007-007
3'	4520-0007-008	4520-0007-008	4520-0007-008	4520-0007-008	4520-0007-008	4520-0007-008
4'	4520-0007-009	4520-0007-009	4520-0007-009	4520-0007-009	4520-0007-009	4520-0007-009
5'	4520-0007-010	4520-0007-010	4520-0007-010	4520-0007-010	4520-0007-010	4520-0007-010
6'	4520-0007-011	4520-0007-011	4520-0007-011	4520-0007-011	4520-0007-011	4520-0007-011
8'	NA	4520-0007-012	4520-0007-012	4520-0007-012	4520-0007-012	4520-0007-012
10'	NA	4520-0007-013	4520-0007-013	4520-0007-013	4520-0007-013	4520-0007-013
DISCONNECT SW.	THERMOSTAT	TRANSFORMER		POWER RELAY		
410170001	2-STAGE 5813-0023-000 SINGLE POLE 5813-11014-000	120V 5018-11003-000 208/240V 5018-11003-001	277V 5018-11003-002 347V 5018-11003-003	24V 410171001 120V 410171002	208/240V/277V 410171003	

BDBSL SERIES

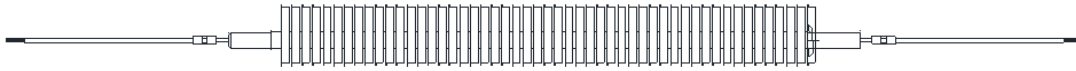

DISCRPTION	PART NUMBERS					
	120V	208V	240V	277V	347V	600V
*ELEMENT (100 WATTS/FT)						
28" HEATER	1802-2001-047	1802-2001-048	1802-2001-049	NA	NA	NA
3'	1802-2001-053	1802-2001-054	1802-2001-055	1802-2001-056	NA	NA
4'	1802-2001-059	1802-2001-060	1802-2001-061	1802-2001-062	1802-2001-232	NA
5'	1802-2001-065	1802-2001-066	1802-2001-067	1802-2001-068	1802-2001-242	NA
6'	1802-2001-071	1802-2001-072	1802-2001-073	1802-2001-074	1802-2001-252	1802-2001-253
8'	NA	1802-2001-077	1802-2001-078	1802-2001-079	1802-2001-262	1802-2001-263
10'	NA	1802-2001-081	1802-2001-082	1802-2001-083	1802-2001-272	1802-2001-273
*ELEMENT (125 WATTS/FT)						
28" HEATER	1802-2001-085	1802-2001-086	1802-2001-048	1802-2001-049	NA	NA
3'	1802-2001-087	1802-2001-088	1802-2001-054	1802-2001-055	1802-2001-220	NA
4'	1802-2001-089	1802-2001-090	1802-2001-060	1802-2001-061	1802-2001-230	NA
5'	1802-2001-091	1802-2001-092	1802-2001-066	1802-2001-067	1802-2001-240	1802-2001-241
6'	1802-2001-093	1802-2001-094	1802-2001-072	1802-2001-073	1802-2001-250	1802-2001-251
8'	NA	1802-2001-095	1802-2001-077	1802-2001-078	1802-2001-260	1802-2001-261
10'	NA	1802-2001-096	1802-2001-081	1802-2001-082	1802-2001-270	1802-2001-271
*ELEMENT (150 WATTS/FT)						
28" HEATER	1802-2001-051	1802-2001-001	1802-2001-000	1802-2001-052	NA	NA
3'	1802-2001-057	1802-2001-007	1802-2001-006	1802-2001-058	1802-2001-218	NA
4'	1802-2001-063	1802-2001-013	1802-2001-012	1802-2001-064	1802-2001-228	NA
5'	1802-2001-069	1802-2001-019	1802-2001-018	1802-2001-070	1802-2001-238	1802-2001-239
6'	1802-2001-075	1802-2001-025	1802-2001-024	1802-2001-076	1802-2001-248	1802-2001-249
8'	NA	1802-2001-031	1802-2001-030	1802-2001-080	1802-2001-258	1802-2001-259
10'	NA	1802-2001-035	1802-2001-034	1802-2001-084	1802-2001-268	1802-2001-269
*ELEMENT (188 WATTS/FT)						
24" HEATER	1802-2001-038	1802-2001-039	1802-2001-040	1802-2001-041	1802-2001-200	NA
28" HEATER	1802-2001-005	1802-2001-002	1802-2001-001	1802-2001-000	NA	NA
3'	1802-2001-011	1802-2001-008	1802-2001-007	1802-2001-006	1802-2001-216	NA
4'	1802-2001-017	1802-2001-014	1802-2001-013	1802-2001-012	1802-2001-226	1802-2001-227
5'	1802-2001-023	1802-2001-020	1802-2001-019	1802-2001-018	1802-2001-236	1802-2001-237
6'	1802-2001-029	1802-2001-026	1802-2001-025	1802-2001-024	1802-2001-246	1802-2001-247
8'	NA	1802-2001-032	1802-2001-031	1802-2001-030	1802-2001-256	1802-2001-257
10'	NA	1802-2001-036	1802-2001-035	1802-2001-034	1802-2001-266	1802-2001-267
LINEAR LIMIT		DISCONNECT SW.	THERMOSTAT			
28" HEATER	4520-0007-007	410170001	2-STAGE	SINGLE POLE		
3'	4520-0007-008		5813-0023-000	410129002		
4'	4520-0007-009					
5'	4520-0007-010					
6'	4520-0007-011					
8'	4520-0007-012					
10'	4520-0007-013					

ICST SERIES



DISCRIPTION	PART NUMBERS					
	120V	208V	240V	277V	347V	600V
*ELEMENT (125 WATTS/FT)						
28" HEATER	1802-2001-085	1802-2001-086	1802-2001-048	1802-2001-049	NA	NA
3'	1802-2001-087	1802-2001-088	1802-2001-054	1802-2001-055	1802-2001-220	NA
4'	1802-2001-089	1802-2001-090	1802-2001-060	1802-2001-061	1802-2001-230	NA
5'	1802-2001-091	1802-2001-092	1802-2001-066	1802-2001-067	1802-2001-240	1802-2001-241
6'	1802-2001-093	1802-2001-094	1802-2001-072	1802-2001-073	1802-2001-250	1802-2001-251
8'	NA	1802-2001-095	1802-2001-077	1802-2001-078	1802-2001-260	1802-2001-261
10'	NA	1802-2001-096	1802-2001-081	1802-2001-082	1802-2001-270	1802-2001-271
*ELEMENT (188 WATTS/FT)						
28" HEATER	1802-2001-005	1802-2001-002	1802-2001-001	1802-2001-000	NA	NA
3'	1802-2001-011	1802-2001-008	1802-2001-007	1802-2001-006	1802-2001-216	NA
4'	1802-2001-017	1802-2001-014	1802-2001-013	1802-2001-012	1802-2001-226	1802-2001-227
5'	1802-2001-023	1802-2001-020	1802-2001-019	1802-2001-018	1802-2001-236	1802-2001-237
6'	1802-2001-029	1802-2001-026	1802-2001-025	1802-2001-024	1802-2001-246	1802-2001-247
8'	NA	1802-2001-032	1802-2001-031	1802-2001-030	1802-2001-256	1802-2001-257
10'	NA	1802-2001-036	1802-2001-035	1802-2001-034	1802-2001-266	1802-2001-267
*ELEMENT (250 WATTS/FT)						
28" HEATER	1802-2001-004	1802-2001-003	1802-2001-002	1802-2001-001	1802-2001-202	NA
3'	1802-2001-010	1802-2001-009	1802-2001-008	1802-2001-007	1802-2001-214	NA
4'	1802-2001-016	1802-2001-015	1802-2001-014	1802-2001-013	1802-2001-224	1802-2001-225
5'	1802-2001-022	1802-2001-021	1802-2001-020	1802-2001-019	1802-2001-234	1802-2001-235
6'	1802-2001-028	1802-2001-027	1802-2001-026	1802-2001-025	1802-2001-244	1802-2001-245
8'	NA	1802-2001-033	1802-2001-032	1802-2001-031	1802-2001-254	1802-2001-255
10'	NA	1802-2001-037	1802-2001-036	1802-2001-035	1802-2001-264	1802-2001-265



DISCRIPTION	PART NUMBERS					
	120V	208V	240V	277V	347V	600V
LINEAR LIMIT						
28" HEATER	4520-2018-001	4520-2018-001	4520-2018-001	4520-2018-001	4520-2018-001	4520-2018-001
3'	4520-2018-002	4520-2018-002	4520-2018-002	4520-2018-002	4520-2018-002	4520-2018-002
4'	4520-2018-003	4520-2018-003	4520-2018-003	4520-2018-003	4520-2018-003	4520-2018-003
5'	4520-2018-004	4520-2018-004	4520-2018-004	4520-2018-004	4520-2018-004	4520-2018-004
6'	4520-2018-005	4520-2018-005	4520-2018-005	4520-2018-005	4520-2018-005	4520-2018-005
8'	NA	4520-2018-006	4520-2018-006	4520-2018-006	4520-2018-006	4520-2018-006
10'	NA	4520-2018-007	4520-2018-007	4520-2018-007	4520-2018-007	4520-2018-007
DISCONNECT SW.	THERMOSTAT	TRANSFORMER RELAY		J-BOX COVER	FRONT COVER	
DS	2-STAGE 5813-0023-000 SINGLE POLE 5813-11014-000	120V 5018-11003-000 208/240V 5018-11003-001	277V 5018-11003-002 347V 5018-11003-003	ALL MODELS 1402-2250-000	1402-2251-000 1402-2251-001 1402-2251-002 1402-2251-003 1402-2251-004 1402-2251-005 1402-2251-006	28" 3' 4' 5' 6' 8' 10'

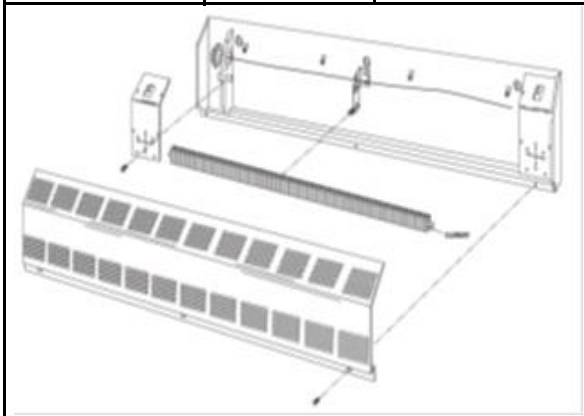

CSL & CPL SERIES

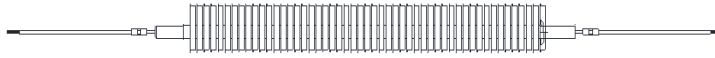









DISCRIPTION	PART NUMBERS					
	120V	208V	240V	277V	347V	600V
*ELEMENT (125 WATTS/FT)						
28" HEATER	1802-2001-085	1802-2001-086	1802-2001-048	1802-2001-049	NA	NA
3'	1802-2001-087	1802-2001-088	1802-2001-054	1802-2001-055	1802-2001-220	NA
4'	1802-2001-089	1802-2001-090	1802-2001-060	1802-2001-061	1802-2001-230	NA
5'	1802-2001-091	1802-2001-092	1802-2001-066	1802-2001-067	1802-2001-240	1802-2001-241
6'	1802-2001-093	1802-2001-094	1802-2001-072	1802-2001-073	1802-2001-250	1802-2001-251
8'	NA	1802-2001-095	1802-2001-077	1802-2001-078	1802-2001-260	1802-2001-261
10'	NA	1802-2001-096	1802-2001-081	1802-2001-082	1802-2001-270	1802-2001-271
*ELEMENT (188 WATTS/FT)						
28" HEATER	1802-2001-005	1802-2001-002	1802-2001-001	1802-2001-000	NA	NA
3'	1802-2001-011	1802-2001-008	1802-2001-007	1802-2001-006	1802-2001-216	NA
4'	1802-2001-017	1802-2001-014	1802-2001-013	1802-2001-012	1802-2001-226	1802-2001-227
5'	1802-2001-023	1802-2001-020	1802-2001-019	1802-2001-018	1802-2001-236	1802-2001-237
6'	1802-2001-029	1802-2001-026	1802-2001-025	1802-2001-024	1802-2001-246	1802-2001-247
8'	NA	1802-2001-032	1802-2001-031	1802-2001-030	1802-2001-256	1802-2001-257
10'	NA	1802-2001-036	1802-2001-035	1802-2001-034	1802-2001-266	1802-2001-267
*ELEMENT (250 WATTS/FT)						
28" HEATER	1802-2001-004	1802-2001-003	1802-2001-002	1802-2001-001	1802-2001-202	NA
3'	1802-2001-010	1802-2001-009	1802-2001-008	1802-2001-007	1802-2001-214	NA
4'	1802-2001-016	1802-2001-015	1802-2001-014	1802-2001-013	1802-2001-224	1802-2001-225
5'	1802-2001-022	1802-2001-021	1802-2001-020	1802-2001-019	1802-2001-234	1802-2001-235
6'	1802-2001-028	1802-2001-027	1802-2001-026	1802-2001-025	1802-2001-244	1802-2001-245
8'	NA	1802-2001-033	1802-2001-032	1802-2001-031	1802-2001-254	1802-2001-255
10'	NA	1802-2001-037	1802-2001-036	1802-2001-035	1802-2001-264	1802-2001-265

* 1, 2 OR 3 ELEMENTS MAY BE REQUIRED. VOLTAGE AND WATTAGE ARE STAMPED ON END OF ELEMENTS. DIVIDE THE WATTAGE BY THE HEATER LENGTH (FEET) TO DETERMINE WATTS/FOOT OF ELEMENT. THEN USE THIS DATA TO DETERMINE PART NUMBER OF HEATING ELEMENT.



DISCRIPTION	PART NUMBERS					
	120V	208V	240V	277V	347V	600V
LINEAR LIMIT						
28" HEATER	4520-0007-007	4520-0007-007	4520-0007-007	4520-0007-007	4520-0007-007	4520-0007-007
3'	4520-0007-008	4520-0007-008	4520-0007-008	4520-0007-008	4520-0007-008	4520-0007-008
4'	4520-0007-009	4520-0007-009	4520-0007-009	4520-0007-009	4520-0007-009	4520-0007-009
5'	4520-0007-010	4520-0007-010	4520-0007-010	4520-0007-010	4520-0007-010	4520-0007-010
6'	4520-0007-011	4520-0007-011	4520-0007-011	4520-0007-011	4520-0007-011	4520-0007-011
8'	NA	4520-0007-012	4520-0007-012	4520-0007-012	4520-0007-012	4520-0007-012
10'	NA	4520-0007-013	4520-0007-013	4520-0007-013	4520-0007-013	4520-0007-013

DISCONNECT SW.	THERMOSTAT	TRANSFORMER RELAY		24V TRANSFORMER
				
410170001	2-STAGE 5813-0023-000 SINGLE POLE 5813-0024-000	120V 5018-11003-000 208/240V 5018-11003-001	277V 5018-11003-002 347V 5018-11003-003	208/240V PRIMARY 490026001 277V PRIMARY 490026002

CIRCUIT BREAKER	POWER RELAY	
		
2-POLE, 30A 1226-7009-013 2-POLE, 60A 1226-7009-010 3-POLE, 30A 1226-7009-005 3-POLE, 60A 1226-7009-002	24V 410171001 120V 410171002 208/240V 410171003	277V 410171003



ASLC SERIES



DISCRIPTION	PART NUMBERS					
	120V	208V	240V	277V	347V	600V
*ELEMENT (100 WATTS/FT)						
28" HEATER	1802-2001-047	1802-2001-048	1802-2001-049	NA	NA	NA
3'	1802-2001-053	1802-2001-054	1802-2001-055	1802-2001-056	NA	NA
4'	1802-2001-059	1802-2001-060	1802-2001-061	1802-2001-062	1802-2001-232	NA
5'	1802-2001-065	1802-2001-066	1802-2001-067	1802-2001-068	1802-2001-242	NA
6'	1802-2001-071	1802-2001-072	1802-2001-073	1802-2001-074	1802-2001-252	1802-2001-253
8'	NA	1802-2001-077	1802-2001-078	1802-2001-079	1802-2001-262	1802-2001-263
10'	NA	1802-2001-081	1802-2001-082	1802-2001-083	1802-2001-272	1802-2001-273
*ELEMENT (125 WATTS/FT)						
28" HEATER	1802-2001-085	1802-2001-086	1802-2001-048	1802-2001-049	NA	NA
3'	1802-2001-087	1802-2001-088	1802-2001-054	1802-2001-055	1802-2001-220	NA
4'	1802-2001-089	1802-2001-090	1802-2001-060	1802-2001-061	1802-2001-230	NA
5'	1802-2001-091	1802-2001-092	1802-2001-066	1802-2001-067	1802-2001-240	1802-2001-241
6'	1802-2001-093	1802-2001-094	1802-2001-072	1802-2001-073	1802-2001-250	1802-2001-251
8'	NA	1802-2001-095	1802-2001-077	1802-2001-078	1802-2001-260	1802-2001-261
10'	NA	1802-2001-096	1802-2001-081	1802-2001-082	1802-2001-270	1802-2001-271
*ELEMENT (150 WATTS/FT)						
28" HEATER	1802-2001-051	1802-2001-001	1802-2001-000	1802-2001-052	NA	NA
3'	1802-2001-057	1802-2001-007	1802-2001-006	1802-2001-058	1802-2001-218	NA
4'	1802-2001-063	1802-2001-013	1802-2001-012	1802-2001-064	1802-2001-228	NA
5'	1802-2001-069	1802-2001-019	1802-2001-018	1802-2001-070	1802-2001-238	1802-2001-239
6'	1802-2001-075	1802-2001-025	1802-2001-024	1802-2001-076	1802-2001-248	1802-2001-249
8'	NA	1802-2001-031	1802-2001-030	1802-2001-080	1802-2001-258	1802-2001-259
10'	NA	1802-2001-035	1802-2001-034	1802-2001-084	1802-2001-268	1802-2001-269
*ELEMENT (188 WATTS/FT)						
24" HEATER	1802-2001-038	1802-2001-039	1802-2001-040	1802-2001-041	1802-2001-200	NA
28"	1802-2001-005	1802-2001-002	1802-2001-001	1802-2001-000	NA	NA
3'	1802-2001-011	1802-2001-008	1802-2001-007	1802-2001-006	1802-2001-216	NA
4'	1802-2001-017	1802-2001-014	1802-2001-013	1802-2001-012	1802-2001-226	1802-2001-227
5'	1802-2001-023	1802-2001-020	1802-2001-019	1802-2001-018	1802-2001-236	1802-2001-237
6'	1802-2001-029	1802-2001-026	1802-2001-025	1802-2001-024	1802-2001-246	1802-2001-247
8'	NA	1802-2001-032	1802-2001-031	1802-2001-030	1802-2001-256	1802-2001-257
10'	NA	1802-2001-036	1802-2001-035	1802-2001-034	1802-2001-266	1802-2001-267
*ELEMENT (250 WATTS/FT)						
28" HEATER	1802-2001-004	1802-2001-003	1802-2001-002	1802-2001-001	1802-2001-202	NA
3'	1802-2001-010	1802-2001-009	1802-2001-008	1802-2001-007	1802-2001-214	NA
4'	1802-2001-016	1802-2001-015	1802-2001-014	1802-2001-013	1802-2001-224	1802-2001-225
5'	1802-2001-022	1802-2001-021	1802-2001-020	1802-2001-019	1802-2001-234	1802-2001-235
6'	1802-2001-028	1802-2001-027	1802-2001-026	1802-2001-025	1802-2001-244	1802-2001-245
8'	NA	1802-2001-033	1802-2001-032	1802-2001-031	1802-2001-254	1802-2001-255
10'	NA	1802-2001-037	1802-2001-036	1802-2001-035	1802-2001-264	1802-2001-265
LINEAR LIMIT		DISCONNECT SW.		THERMOSTAT		P.E. SWITCH
28" HEATER	4520-0007-007	410170001		2-STAGE		410172001
3'	4520-0007-008			5813-0023-000		
4'	4520-0007-009			SINGLE POLE		
5'	4520-0007-010			5813-0024-000		
6'	4520-0007-011					
8'	4520-0007-012					
10'	4520-0007-013					
TRANSFORMER		POWER RELAY				
120V	277V	24V	208/240V/277V			
5018-11003-000	5018-11003-002	410171001	410171003			
208/240V	347V	120V				
5018-11003-001	5018-11003-003	410171002				

THX FLOOR DROP-IN CONVECTOR							
ELEMENTS							
2 FOOT 188W/FT		2 FOOT 250W/FT		3 FOOT 188W/FT		3 FOOT 250W/FT	
208V	1802-2001-039	208V	1802-2001-198	208V	1802-2001-008	208V	1802-2001-009
240V	1802-2001-040	240V	1802-2001-099	240V	1802-2001-007	240V	1802-2001-008
277V	1802-2001-041	277V	1802-2001-200	277V	1802-2001-006	277V	1802-2001-007
4 FOOT 188W/FT		4 FOOT 250W/FT		5 FOOT 188W/FT		5 FOOT 250W/FT	
208V	1802-2001-014	208V	1802-2001-015	208V	1802-2001-020	208V	1802-2001-021
240V	1802-2001-013	240V	1802-2001-014	240V	1802-2001-019	240V	1802-2001-020
277V	1802-2001-012	277V	1802-2001-013	277V	1802-2001-018	277V	1802-2001-019

GRILLE							
2 FOOT FLUSH		2 FOOT SURFACE		3 FOOT FLUSH		3 FOOT SURFACE	
ALUMINUM	2501-11033-001	ALUMINUM	2501-11033-005	ALUMINUM	2501-11033-002	ALUMINUM	2501-11033-006
BLACK	2501-11033-101	BLACK	2501-11033-105	BLACK	2501-11033-102	BLACK	2501-11033-106
WHITE	2501-11033-201	WHITE	2501-11033-205	WHITE	2501-11033-202	WHITE	2501-11033-206
4 FOOT FLUSH		4 FOOT SURFACE		5 FOOT FLUSH		5 FOOT SURFACE	
ALUMINUM	2501-11033-003	ALUMINUM	2501-11033-007	ALUMINUM	2501-11033-004	ALUMINUM	2501-11033-008
BLACK	2501-11033-103	BLACK	2501-11033-107	BLACK	2501-11033-104	BLACK	2501-11033-108
WHITE	2501-11033-203	WHITE	2501-11033-207	WHITE	2501-11033-204	WHITE	2501-11033-208

TRANSFORMER	
277V	208/240V
5018-11003-002	5018-11003-001

TIME DELAY RELAY		
24V CONTROL	120V CONTROL	208-277V CONTROL
410171001	410171002	410171003

LINEAR LIMIT			
2 FOOT	3 FOOT	4 FOOT	5 FOOT
4520-0007-007	4520-0007-008	4520-0007-009	4520-0007-010

MANUAL RESET LIMIT			
2 FOOT	3 FOOT	4 FOOT	5 FOOT
4520-2017-000	4520-2017-000	4520-2017-001	4520-2017-001

POWER ON/OFF SW
ALL MODELS 410170001
J-BOX COVER
ALL MODELS 1215-11125-000

XRM SERIES

ELEMENT

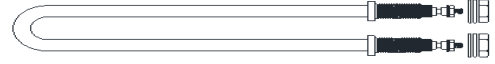
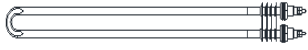

1802-7076-002 M2081B M6083B	1802-7076-007 M4581B M13583B	1802-2110-007 M6043A 1802-2110-009 M4581A M13583A	HE45208 M4581 M13583 HE45240 M4521 M13523	HE20208 M6083 HE20240 M6023 HE20480 M6043
1802-7076-003 M2021B M6023B	1802-7076-008 M4521B M13523B	1802-2110-011 M4521A M13523A	HE45480 M4541 M13543 HE45600 M13563	HE20600 M6063
1802-7076-004 M6071B	1802-7076-009 M13571B	1802-2110-015 M4541A M13543A		
1802-7076-005 M2041B M6043B	1802-7076-010 M4541B M13543B	1802-2110-016 M13563A		
1802-7076-006 M2061B M6063B	1802-7076-011 M4561B M13563B			

NOTES







6KW AND 13.5KW UNITS TAKE THREE ELEMENTS





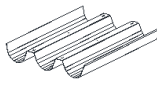



REFLECTOR

891755004 M6023B M6043B	891755002 M13523B M13543B M4521B M4541B
--------------------------------------	--

VRP/VRS SERIES RADIANT HEATERS

ELEMENTS					REFLECTOR			
								
PART NUMBER	TYPE	VOLTS	WATTS	USED WITH FIXTURE	5007-2003-000	5007-2003-001	5007-2003-002	
2MS08208 2MS08240 2MS08277 2MS08347 2MS08480 2MS08600	METAL SHEATH	208 240 277 347 480 600	850	RP22 RS2 RP32 RS32	RP223ASA RS223ASA	RP233ASA RS233ASA	RP243ASA RS243ASA	
2QT10208 2QT10240 2QT10277 NA	QUARTS TUBE	208 240 277 NA	1000		5007-2010-000 RP2235A RS2235A	5007-2010-001 RP2335A RS2335A	5007-2010-002 RP2435A RS2435A	
2QL16208 2QL16240 2QL16277 2QL16347 2QL16480 2QL16600	QUARTS LAMP	208 240 277 347 480 600	1600		5007-2011-000 RP226ASA RS226ASA	5007-2011-001 RP236ASA RS236ASA	5007-2011-002 RP246ASA RS246ASA	
3MS15208 3MS15240 3MS15277 3MS15347 3MS15480 3MS15600	METAL SHEATH	208 240 277 347 480 600	1500		RP23 RS23 RP33 RS33	5007-2009-000 RP2265A RP2295A RS2265A RS2295A	5007-2009-001 RP2365A RP2395A RS2365A RS2395A	5007-2009-002 RP2465A RP2495A RS2465A RS2495A
3QT15208 3QT15240 3QT15277 3QT15347 3QT15480 3QT15600	QUARTS TUBE	208 240 277 347 480 600	1500					
3QL25208 3QL25240 3QL25277 3QL25347 3QL25480 3QL25600	QUARTS LAMP	208 240 277 347 480 600	2500			5007-2008-000 RP323ASA RS323ASA	5007-2008-001 RP333ASA RS333ASA	5007-2008-002 RP343ASA RS343ASA
3QT15208 3QT15240 3QT15277 3QT15347 3QT15480 3QT15600	QUARTS TUBE	208 240 277 347 480 600	1500	5007-2017-000 RP3235A RS3235A		5007-2017-001 RP3335A RS3335A	5007-2017-002 RP3435A RS3435A	
3QL25208 3QL25240 3QL25277 3QL25347 3QL25480 3QL25600	QUARTS LAMP	208 240 277 347 480 600	2500	5007-2018-000 RP326ASA RS326ASA		5007-2018-001 RP336ASA RS336ASA	5007-2018-002 RP346ASA RS346ASA	
3QL25208 3QL25240 3QL25277 3QL25347 3QL25480 3QL25600	QUARTS LAMP	208 240 277 347 480 600	2500	5007-2016-000 RP3265A RP3295A RS3265A RS3295A		5007-2016-001 RP3365A RP3395A RS3365A RS3395A	5007-2016-002 RP3465A RP3495A RS3465A RS3495A	
					ELEMENT TERM BUSH*		TERMINAL BLOCK*	
								
					ALL MODELS 1213-0070-000	ALL MODELS 1224-0049-000		
					NOTES			
					* FOUR REQUIRED ON 2 ELEMENT AND SIX FOR 3 ELEMENT FIXTURES			
								
								

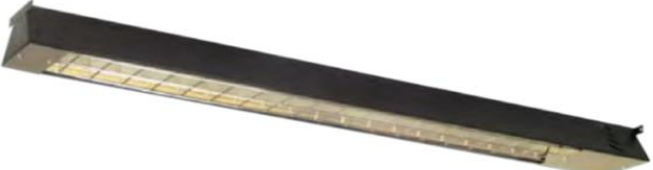

JRK SERIES

ELEMENT		REFLECTOR	
			
1802-2113-501 RK41512A	1802-2113-515 RK53020A	5007-2013-000 RK41512A RK42020A RK42024A RK42027A RK42034A RK42048A RK42060A	5007-2013-001 RK53020A RK53024A RK53027A RK53034A RK53048A RK53060A
1802-2113-509 RK42020A	1802-2113-516 RK53024A		
1802-2113-510 RK42024A	1802-2113-517 RK53027A		
1802-2113-511 RK42027A	1802-2113-518 RK53034A		
1802-2113-512 RK42034A	1802-2113-519 RK53048A		
1802-2113-513 RK42048A	1802-2113-520 RK53060A		
1802-2113-514 RK42060A			
CHAIN 2 REQ.	"S" HOOK 4 REQ.	TERMINAL COVER LONG	TERMINAL COVER SHORT
			
1404-2000-001 ALL MODELS	2706-2000-000 ALL MODELS	1402-2275-000 ALL MODELS	1402-2275-001 ALL MODELS
			

RCC COVE HEATERS (C & D SERIES)

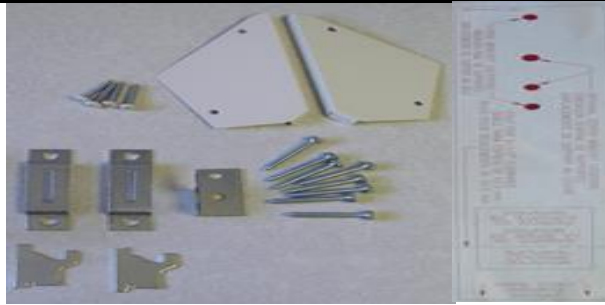
PARTS KIT*

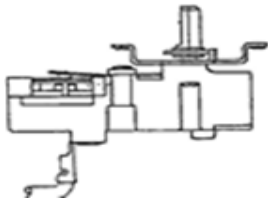

WHITE 3303-2032-000	DOVE GRAY 3303-2032-001	DESERT TAN 3303-2032-002
CENTER SUP BRACKET**	THERMOSTAT	THERMOSTAT KNOB
		
ALL MODELS 1215-2309-000	ALL MODELS 410129001	ALL MODELS 3301-2020-006













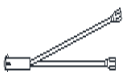

NOTES

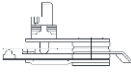

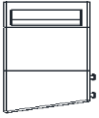

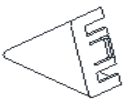





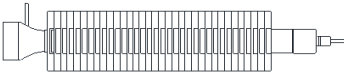
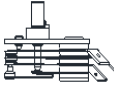

REPLACE HEATER IF FRONT COVER OR ELEMENT IS NEEDED

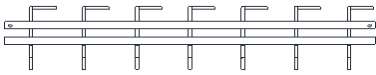
*** PARTS KIT INCLUDES MOUNTING BRACKETS, MOUNTING TEMPLATE, AND END CAPS**





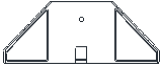

**** 1500 & 1800 WATT MODELS TAKE TWO CENTER SUPPORT BRACKETS**

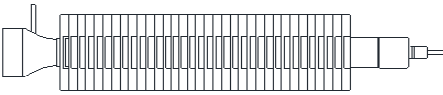

FBE SERIES					
ELEMENT		SWITCH			LIGHT
					
1802-2087-000 FBE15002C FBE15002CA		5216-2007-000 FBE1000A FBE1200 FBE1250A	5216-2010-000 FBE15002 FBE15002A	5216-2027-000 FBE15002B FBE15002C FBE15002CA	3510-2008-001 FBE1504C
LIMIT	THERMOSTAT	KNOB		FACE PLATE	
					
4520-2011-004 FBE1500C FBE15002A FBE15002B FBE15002C FBE15002CA	5813-2058-001 FBE1200 FBE1200C FBE1500C FBE15002B FBE15002C FBE15002CA FBE1504C	3301-2017-000 FBE1000A FBE1250A FBE15002 FBE15002A	3301-2011-003 FBE1200 FBE1200C FBE1500C FBE15002B FBE15002C FBE15002CA FBE1504C	1402-2122-139 FBE1000A	1402-2122-136 FBE15002
				1402-2122-141 FBE1200	1402-2122-138 FBE15002A
				1402-2122-125 FBE1200C	1402-2122-142 FBE15002B
				1402-2122-140 FBE1250A	1402-2122-626 FBE15002CA
END CAP RIGHT	END CAP LEFT	LEG RIGHT	LEG LEFT	CORD	CONTROL COVER
					
1800-2047-001 FBE1200C FBE1500C FBE15002C FBE15002CA FBE1504C	1800-2048-001 FBE1200C FBE1500C FBE15002C FBE15002CA FBE1504C	3507-2004-001 FBE1200C FBE1500C FBE15002C FBE15002CA FBE1504C	3507-2005-001 FBE1200C FBE1500C FBE15002C FBE15002CA FBE1504C	1420-2027-001 FBE15002C 1420-11013-000 FBE15002CA	1402-2243-001 FBE15002B FBE15002C FBE15002CA
					

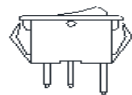
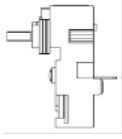
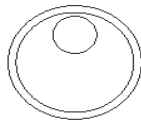

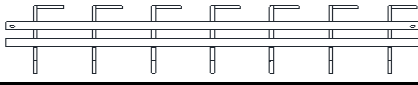
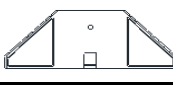

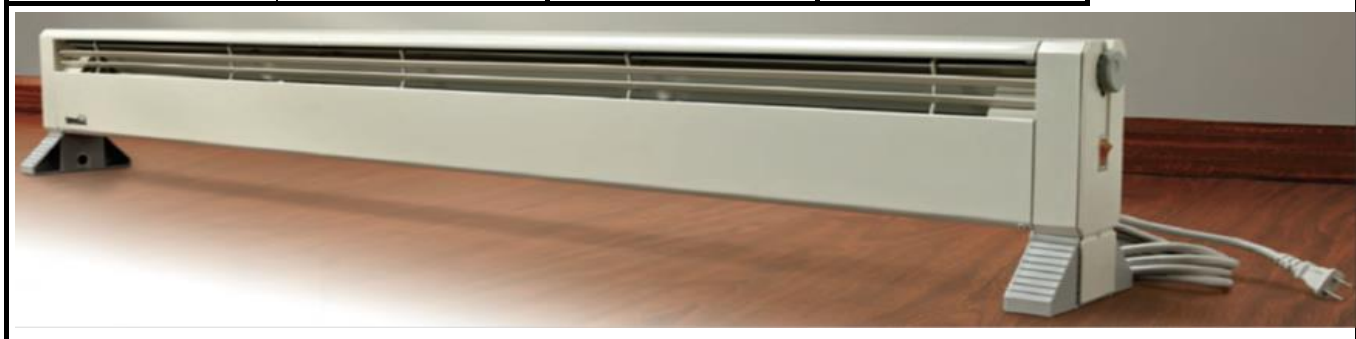

LFP SERIES (OBSOLETE)					
ELEMENT		THERMOSTAT		LIMIT	
					
1802-2067-023 LFP6152D LFP6152E LFP6152EA		5813-2019-000 LFP6152 LFP6152D LFP6152E LFP6152EA		410163004 LFP6152 LFP6152D LFP6152E LFP6152EA	
1802-2067-001 LFP675D		5813-2001-000 LFP675 LFP675D		4520-2010-001 LFP675 LFP675D	
GRILLE	LIGHT	DIODE BRIDGE	FRONT COVER	CORD	
					
2501-2012-015 LFP6152 LFP6152D LFP6152E LFP6152EA	2501-2012-013 LFP675 LFP675D	3510-2006-000 LFP6152 LFP6152D LFP6152E LFP6152EA	DBKIT LFP6152 LFP6152D LFP6152E LFP6152EA	1402-2066-609 LFP6152EA	
1420-11013-000 LFP6152D LFP6152E LFP6152EA					
KNOB	LEG				
					
3301-2011-001 LFP6152 LFP6152D LFP6152E LFP6152EA LFP675 LFP675D	3507-2003-000 LFP6152 LFP6152D LFP6152E LFP6152EA LFP675 LFP675D	5216-2007-000 LFP6152 LFP6152D LFP6152E LFP6152EA LFP675 LFP675D	1800-2027-000 LFP6152 LFP6152D LFP6152E LFP6152EA LFP675 LFP675D		

FHP SERIES







ELEMENT		LIMIT		SWITCH	
					
1802-2067-001 FHP0750KCT FHP0750KCTA FHP0750T FHP0750TA	1802-2067-023 FHP1500KCT FHP1500KCTA FHP1500T FHP1500TA	4520-0011-000 FHP0750KCT FHP0750KCTA FHP0750T FHP0750TA	410163004 FHP1500KCT FHP1500KCTA FHP1500T FHP1500TA	5216-11020-000 FHP0750KCT FHP0750KCTA FHP0750T FHP0750TA FHP1500KCT FHP1500KCTA FHP1500T FHP1500TA	
THERMOSTAT		KNOB	FRONT COVER		END CAP
					
5813-11012-000 FHP0750KCT FHP0750KCTA FHP0750T FHP0750TA FHP1500KCT FHP1500KCTA FHP1500T FHP1500TA	3301-2011-005 FHP0750KCT FHP0750KCTA FHP0750T FHP0750TA FHP1500KCT FHP1500KCTA FHP1500T FHP1500TA	1402-2066-607 FHP0750KCT FHP0750KCTA FHP0750T FHP0750TA	1402-2066-609 FHP1500KCT FHP1500KCTA FHP1500T FHP1500TA	1800-2027-000 FHP0750KCT FHP0750KCTA FHP0750T FHP0750TA FHP1500KCT FHP1500KCTA FHP1500T FHP1500TA	
GRILLE		LEGS (2 REQ)	CORD		
					
2501-2012-013 FHP0750KCT FHP0750KCTA FHP0750T FHP0750TA	2501-2012-015 FHP1500KCT FHP1500KCTA FHP1500T FHP1500TA	3507-2003-000 FHP0750KCT FHP0750KCTA FHP0750T FHP0750TA FHP1500KCT FHP1500KCTA FHP1500T FHP1500TA	1420-11013-000 FHP0750KCT FHP0750KCTA FHP0750T FHP0750TA FHP1500KCT FHP1500KCTA FHP1500T FHP1500TA		

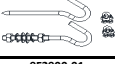

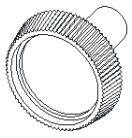
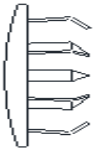
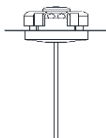
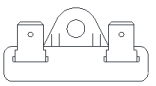
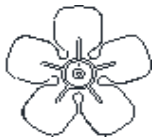



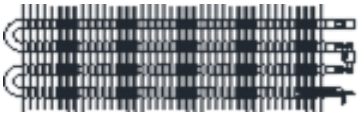



DOE INDUSTRIAL/COMMERCIAL CEILING FANS



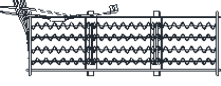





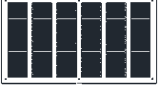

			ASSEMBLY HAS SHACKLE AND RUBBER ROLLER					
MODEL	BLADES SET OF 3	MOTOR	DOWN ROD	SHACKLE	UPPER CANOPY	LOWER CANOPY	RUBBER ROLLER	SPEED CONTROL
56001HP	985600-1HP	9M5600-1HP	9D24BW	9F2900-03A	9F2900-07A	9F2900-08A	9F2900-04A	12003
56001HP-BRN	985600-1HPB		9D24BB	9F2900-03A	9FP029	9FP030	9F2900-04A	12003
56001HPDOE-K	985600-1HP	9M5600-1HP	9D24BW	9F2900-03A	9F2900-07A	9F2900-08A	9F2900-04A	12003
56001HPDOEBRN-K	985600-1HPB		9D24BB	9F2900-03A	9FP029	9FP030	9F2900-04A	12003
56001LCCDOE	985600-1LCC	9M5600-1LCC	9D24BW	9F2900-03A	9F2900-07A	9F2900-08A	9F2900-04A	CTL12004RSPDDOE
56001LCCDOE-K	985600-1LCC	9M5600-1LCC	9D24BW	9F2900-03A	9F2900-07A	9F2900-08A	9F2900-04A	CTL12004RSPDDOE
56201CLSDOE	9856201CLS-1	9M56201CLS-1	9D24BW	9F2900-03A	9F2900-07A	9F2900-08A	9F2900-04A	CTL12004RSPDDOE
56201CLSDOE-K	9856201CLS-1	9M56201CLS-1	9D24BW	9F2900-03A	9F2900-07A	9F2900-08A	9F2900-04A	CTL12004RSPDDOE
56007HPDOE	985600-7HP	9M5600-7HP	9D24BW	9F2900-03A	9F2900-07A	9F2900-08A	9F2900-04A	27708
56007HPDOE-K	985600-7HP	9M5600-7HP	9D24BW	9F2900-03A	9F2900-07A	9F2900-08A	9F2900-04A	27708
60001HPDOE	986000-1HP	9M6000-1HP	9D24BW	9F2900-03A	9F2900-07A	9F2900-08A	9F2900-04A	12003
60001HPDOE-BRN	986000-1HPB		9D24BB	9F2900-03A	9FP029	9FP030	9F2900-04A	12003
60001HPDOE-K	986000-1HP	9M6000-1HP	9D24BW	9F2900-03A	9F2900-07A	9F2900-08A	9F2900-04A	12003
60001HPDOEBRN-K	986000-1HPB		9D24BB	9F2900-03A	9FP029	9FP030	9F2900-04A	12003
36201DOE	983620-1C	9M3620-1C	9D24BB	9F2900-03A	9F2900-07A	9F2900-08A	9F2900-04A	CTL12004RSPDDOE
36201DOE-K	983620-1C	9M3620-1C	9D24BB	9F2900-03A	9F2900-07A	9F2900-08A	9F2900-04A	CTL12004RSPDDOE
48201DOE	9848201-1C	9M48201-1C	9D24BB	9F2900-03A	9F2900-07A	9F2900-08A	9F2900-04A	CTL12004RSPDDOE
48201DOE-K	9848201-1C	9M48201-1C	9D24BB	9F2900-03A	9F2900-07A	9F2900-08A	9F2900-04A	CTL12004RSPDDOE

J HOOK KIT	MODELS ENDING IN K COME WITH SPEED CONTROL		
	VARIABLE SP. CONTROL	VOLTS	AMPS
	12003	120	3
	12006	120	6
	12008	120	8
9F2900-01	12012	120	12
ALL MODELS	27708	277	8
	NOISELESS SP. CONTROL		
	12001N	120	1
	12005N	120	5
	REVERSING SP. CONTROL		
	CTL12004RSPDDOE	120	4

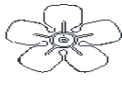
MCSSAR SERIES (OBSOLETE)					
KNOB	PLUG BUTTON	MANUAL RESET	THERMAL FUSE	FAN BLADE	THERMOSTAT
					
3301-11013-000 ALL MODELS	4506-2012-009 ALL MODELS	4520-11019-000 ALL MODELS	4520-2030-000 ALL MODELS	490030103 ALL MODELS	5813-2027-001 ALL MODELS
FAN DELAY			LIGHT		
					
1414-2039-000 MCARWH1802 MCARWH1802AL MCARWH1802BZ MCARWH1802W	410074000 MCARWH4804 MCARWH4804AL MCARWH4804BZ MCARWH4804W MCARWH4807 MCARWH4807AL MCARWH4807AL	MCARWH4807BZ MCARWH4807W MCARWH4808 MCARWH4808AL MCARWH4808BZ MCARWH4808W	3510-2017-000 MCARWH1802 MCARWH1802AL MCARWH1802BZ MCARWH1802W	3510-2017-001 MCARWH4804 MCARWH4804AL MCARWH4804BZ MCARWH4804W MCARWH4807 MCARWH4807AL MCARWH4807BZ MCARWH4807W MCARWH4808 MCARWH4808AL MCARWH4808BZ MCARWH4808W	
MOTOR			ELEMENT		DISCONNECT SWITCH
					
3900-2010-003 MCARWH1802 MCARWH1802AL MCARWH1802BZ MCARWH1802W	3900-2010-000 MCARWH4804 MCARWH4804AL MCARWH4804BZ MCARWH4804W MCARWH4808 MCARWH4808AL MCARWH4808BZ MCARWH4808W	3900-2010-001 MCARWH4807 MCARWH4807AL MCARWH4807BZ MCARWH4807W	302012828 MCARWH1802 MCARWH1802AL MCARWH1802BZ MCARWH1802W 302012811 MCARWH4807 MCARWH4807AL MCARWH4807BZ MCARWH4807W	302012810 MCARWH4804 MCARWH4804AL MCARWH4804BZ MCARWH4804W 302012807 MCARWH4808 MCARWH4808AL MCARWH4808BZ MCARWH4808W	410170001 ALL MODELS 

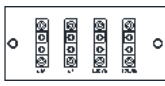

QFG-SERIES (OBSOLETE)													
KNOB		GRILLE		BLOWER ASM				CLIP N FIT BOARD		THERMOSTAT			
													
3301-2040-001 G1512T2M G2024T2M G1512T2MA G2024T2MA G2224T2MA G1512T2MB G2024T2MB G2224T2MB G1512T2MC G2024T2MC G2224T2MC		2501-2046-000 ALL MODELS		1225-2002-000 G1012IF G1512IF G1512M G1512T2M G1512IFMA G1512MA G1512T2MA G1512IFMB G1512MB G1512T2MB G1512IFMC G1512T2MC		1225-2002-001 G1024IF G1524IF G2024IF G2024M G2028IF G2224IF G2224M G2024IFMA G2024MA G2024T2MA G2028IFA G2224IFMA G2224MA		1225-2002-001 G2224T2MA G2024IFMB G2224T2MB G2024MB G2024T2MB G2028IFB G2224T2MC G2024FMC G2024T2MC		1249-2005-000 G1512M G1512T2M G2024M G2024T2M G2224M G1512MA G1512T2MA G2024IFMA G2024MA G2024T2MA G2224IFMA G2224MA G2224T2MA G1512IFMB G1512MB G1512T2MB G2024IFMB G2024MB G2024T2MB G2228IFB G1512IFMC G1512T2MC G2024IFMC G2024T2MC G2224IFC G2224T2MC G2228IFC		410130001 G1512T2M G1512T2MA G1512T2MB G2024T2M G2024T2MA G2224T2MA G2024T2MB G2224T2MB G1512T2MC G2024T2MC G2224T2MC	
ELEMENT 				HI LIMIT 				LIGHT 					
1802-2124-005 G1024IF G2024IF		1802-2124-000 G1512IF G1512IFMA		4520-11012-000 G1512IFMC G1512T2MC		4520-11012-001 G2024IFMC G2024T2MC G2224IFC G2224T2MC G2228IFC		4520-2059-000 G1012IF G1512IF G1512M G1512T2M G1512IFMA G1512MA G1512T2MA G1512IFMB G1512MB G1512T2MB G1024IF G1524IF G2024IF G2024M G2024T2M G2228IFB G2224IFMB G2224T2MB		3510-2017-000 G1012IF G1512IF G1512M G1512T2M G1512IFMA G1512MA G1512T2MA G1512IFMB G1512MB G1512T2MB G1512IFMC G1512T2MC		3510-2017-001 G1024IF G1524IF G2024IF G2024M G2024T2M G2028IF G2224IF G2224M G2024IFMA G2024MA G2024T2MA G2224IFC G2224T2MC G2228IFC	
1802-2125-000 G1512IFMB G1512MB G1512T2MB G1512IFMC G1512T2MC		1802-2125-002 G2024IFMB G2024MB G2024T2MB G2024IFMC G2024T2MC		 Patented Clip-N-Fit® feature (US Patented No. 6,172,343)		4520-2059-000 G1512IFMA G2024MA G2024T2MA G2028IFA G2224IFMA G2224MA G2224T2MA G2024IFMB G2024MB G2024T2MB G2024M G2028IFB G2224IFMB G2224T2MB		3510-2017-000 G1512IFMA G1512MA G1512T2MA G1512IFMB G1512MB G1512T2MB G1512IFMC G1512T2MC		3510-2017-001 G2024IFMB G2024MB G2024T2MB G2224IFMB G2228IFB G2024IFMC G2024T2MC G2224IFC G2224T2MC G2228IFC			
1802-2124-001 G2028IFB		1802-2125-001 G2224IFMB G2224IFC G2224T2MC						3510-2017-000 G2024IFMA G2024MA G2024T2MA G2224IFC G2224T2MC G2228IFC		3510-2017-001 G2224IFC G2224T2MC G2228IFC			
1802-2125-006 G2228IFB G2228IFC		1802-2125-006 G2224T2MB G2224IFC G2224T2MC						3510-2017-000 G2024IFMA G2024MA G2024T2MA G2224IFC G2224T2MC G2228IFC		3510-2017-001 G2224IFC G2224T2MC G2228IFC			
MODELS NOT LISTED ELEMENTS ARE OBSOLETE													

MFQ-SERIES (OBSOLETE)



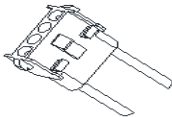
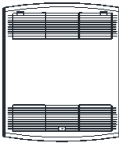
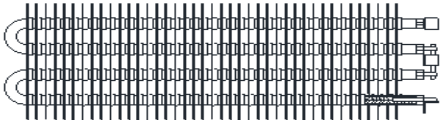

MFQ-SERIES (OBSOLETE)						
GRILLE	ELEMENTS (2 REQ)			MOTOR (2 REQ)		
						
2501-2027-000 ALL MODELS	302012819 Q6003	302012821 Q8003	302012809 Q6004 Q8007	3900-2010-000 Q6003 Q6004 Q60048 Q6006 Q6008 Q8003 Q8004 Q80048 Q8006 Q8008	3900-2010-001 Q6007 Q8007	
	302012820 Q6006 Q8006	302012826 Q80048 302012808 Q6008 Q8004	302012806 Q6007 302012807 Q8008			
	302012825 Q60048					
THERMOSTAT	FAN BLADE (2 REQ)	DISCONNECT SW.	TERMINAL BOARD			
						
410168002 (2REQ.) Q6003 Q60048 Q6006 Q8003 Q80048 Q8006	5813-0023-000 Q6004 Q6007 Q6008 Q8004 Q8007 Q8008	490030103 ALL MODELS	5216-2025-000 ALL MODELS	5823-2002-000 ALL MODELS		
TRANSFORMER		FAN DELAY (2 REQ)	MANUAL LIMIT (2 REQ)			
						
490015017 Q6003 Q8003	490015022 Q60048 Q80048	490015013 Q6006 Q8006	410074000 ALL MODELS	4520-2027-000 ALL MODELS		







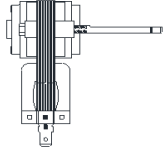



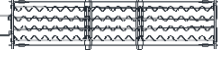

ECP SERIES (OBSOLETE)



PLUG ASSY FEMALE	GRILLE	ELEMENT		LIMIT
				
<p>1016-0114-000 ALL MODELS</p>	<p>2501-2082-000 ALL MODELS</p>	<p>302012808 ECP1024</p>	<p>302012803 ECP1524</p>	<p>4520-2025-001 ALL MODELS</p>
				



MFA SERIES (OBS)

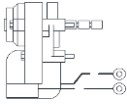
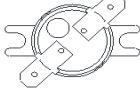

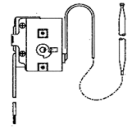
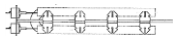
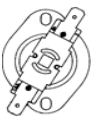

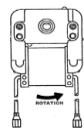

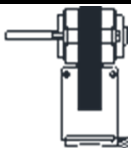
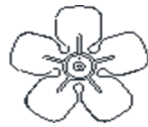
ELEMENTS					LIMIT			
								
1802-2021-000		1802-2021-003		1802-2021-004		4520-2023-000		
A1000IF	A1500IF	A1504IF	A1004IF	A2004T2B	A1000IF	A1500IFBNW	A2004IFB	
A1000IFA	A1500IFA	A1504IFA	A1004IFA	A2004T2BNW	A1000IFB	A1500T	A2004IFBNW	
A1000IFB	A1500IFB	A1504IFB	A1004IFB	A2404IF	A1000IFBNW	A1500T2B	A2004T	
A1000IFBNW	A1500IFBNW	A1504IFBNW	A1004IFBNW	A2404IFA	A1000T	A1500T2BNW	A2004T2B	
A1000T	A1500T	A1504T	A2004IF	A2404IFB	A1000T2B	A1504IF	A2004T2BNW	
A1000TA	A1500TA	A1504TA	A2004IFA	A2404IFBNW	A1000T2BNW	A1504IFB	A2404IF	
A1000T2	A1500T2	A1504T2	A2004IFB	A2404T	A1004IF	A1504IFBNW	A2404IFB	
A1000T2B	A1500T2B	A1504T2B	A2004IFBNW	A2404TA	A1004IFB	A1504T	A2404IFBNW	
A1000T2BNW	A1500T2BNW	A1504T2BNW	A2004T	A2404T2	A1004IFBNW	A1504T2B	A2404T	
			A2004TA	A2404T2B	A1500IF	A1504T2BNW	A2404T2B	
			A2004T2	A2404T2BNW	A1500IFB	A2004IF	A2404T2BNW	
MOTOR					THERMOSTAT			
								
3900-2017-000		3900-2017-001			5813-2001-000		5813-2015-000	
A0500IFA	A1000T2	A0504IFA	A1504IF	A2004TA	A0504TA	A0504T2	A1500T2BNW	
A0500IFB	A1000T2B	A0504IFB	A1504IFA	A2004T2	A1000T	A0504T2B	A1504T2B	
A0500IFBNW	A1000T2BNW	A0504IFBNW	A1504IFB	A2004T2B	A1000TA	A0504T2BNW	A1504T2BNW	
A0750IFA	A1500IF	A0504TA	A1504IFBNW	A2004T2BNW	A1500T	A1000T2	A2004T2	
A0750IFB	A1500IFA	A0504T2	A1504T	A2404IF	A1500TA	A1000T2B	A2004T2B	
A0750IFBNW	A1500IFB	A0504T2B	A1504TA	A2404IFA	A1504T	A1000T2BNW	A2004T2BNW	
A1000IF	A1500IFBNW	A0504T2BNW	A1504T2	A2404IFB	A1504TA	A1500T2	A2404T2B	
A1000IFA	A1500T	A0754IFA	A1504T2B	A2404IFBNW	A1504T2	A1500T2B	A2404T2BNW	
A1000IFB	A1500TA	A0754IFB	A1504T2BNW	A2404T	A2004T			
A1000IFBNW	A1500T2	A0754IFBNW	A2004IF	A2404TA	A2004TA			
A1000T	A1500T2B	A1004IF	A2004IFA	A2404T2	A2404T			
A1000TA	A1500T2BNW	A1004IFA	A2004IFB	A2404T2B	A2404TA			
		A1004IFB	A2004IFBNW	A2404T2BNW	A2404T2			
		A1004IFBNW	A2004T					

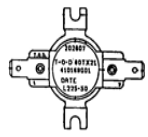

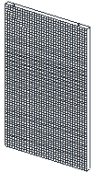
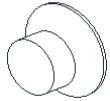
CRA SERIES									
KNOB		GRILLE	LIGHT				ELEMENT		
									
3301-2039-002		2501-2065-000	3510-2017-000	3510-2017-001	3510-2017-002	3510-2017-003	1802-2124-005	1802-2124-000	1802-2124-003
C1012T2	C1012T2AA	C1512FB	C1012IF	C1024IF	C1512IFAB	C1024IFAB	C1024IF	C1512IF	C1012IFA
C1024T2	C1512T2AA	C1512T2B	C1012T2	C1024T2	C1512T2AB	C1024T2AB	C1024T2	C1512T2	C1012T2A
C1512T2	C1012T2AB	C2024IFB	C1512IF	C1524IF	C1512IFB	C1524IFAB	C2024IF	C1512IFA	1802-2124-001
C1524T2	C1024T2AB	C2024T2B	C1512T2	C1524T2	C1512T2B	C1524T2AB	C2024T2	C1512T2A	C2028IFA
C2024T2	C1512T2AB	C2028IFB	C1012IFA	C2024IF	C1512IFC	C2024IFAB	C1024IFA	1802-2124-002	C2028T2A
C2028T2	C1524T2AB	C2224IFB	C1012T2A	C2024T2	C1512T2C	C2024T2AB	C1024T2A	C2224IFA	1802-2127-000
C2224T2	C2024T2AB	C2224T2B	C1512IFA	C2028IF		C2028IFAB	C2024IFA	C2224T2A	C1512IFB
C1012T2A	C2224T2AB	C1512IFC	C1512T2A	C2028T2		C2224IFAB	C2024T2A	1802-2127-005	C1512T2B
C1024T2A	C1512T2B	C1512T2C	C1012IFAA	C2224IF		C2224T2AB	1802-2127-002	C2024IFB	C1512IFC
C1512T2A	C2024T2B	C2024IFC	C1012T2AA	C2224T2		C2024IFB	C2224IFB	C2024T2B	C1512T2C
C1524T2A	C2224T2B	C2024T2C	C1512IFAA	C1024IFA		C2024T2B	C2224T2B	C2024IFC	1802-2127-001
C2024T2A	C1512T2C	C2028IFC	C1512T2AA	C1024T2A		C2028IFB	C2224IFC	C2024T2C	C2028IFB
C2028T2A	C2024T2C	C2224IFC	C1012IFAB	C1524IFA		C2224IFB	C2224T2C	C2028T2A	C2028IFC
C2224T2A	C2224T2C	C2224T2C	C1012T2AB	C1524T2A		C2224T2B	MODELS NOT LISTED ARE OBSOLETE		
				C2024IFA		C2024IFC			
				C2024T2A		C2024T2C			
				C2028IFA		C2028IFC			
				C2028T2A		C2224IFC			
				C2224IFA		C2224T2C			
				C2224T2A					
FAN BLADE	MOTOR				HI LIMIT				CLIP N FIT BOARD
									
1210-2008-000	3900-2017-000	3900-2017-001	3900-2035-000	4520-11007-000	4520-11007-001	4520-2059-000			1249-2005-000
ALL MODELS	C1012IF	C1024IF	C2028IF	C1512IFC	C2024IFC	C1012IF	C2024IF	C2224IFA	C1512IFB
	C1012T2	C1024T2	C2028T2	C1512T2C	C2024T2C	C1012T2	C2024T2	C2224T2A	C1512T2B
	C1512IF	C1524IF	C2224IF		C2028IFC	C1512IF	C1024IFA	C2028IFAB	C2024IFB
	C1512T2	C1524T2	C2224T2		C2224IFC	C1512T2	C1024T2A	C2224IFAB	C2024T2B
	C1012IFA	C2024IF	C2028IFA		C2224T2C	C1012IFA	C1524IFA	C2224T2AB	C2028IFB
	C1012T2A	C2024T2	C2028T2A			C1012T2A	C1524T2A	C2028IFB	C2224IFB
	C1512IFA	C1024IFA	C2224IFA			C1512IFA	C2024IFA	C2224IFB	C2224T2B
	C1512T2A	C1024T2A	C2224T2A			C1512T2A	C2024T2A	C2224T2B	C1512IFC
	C1012IFAA	C1524IFA	C2028IFAB			C1012IFAA	C1024IFAB		C1512T2C
	C1012T2AA	C1524T2A	C2224IFAB			C1012T2AA	C1024T2AB		C2024IFC
	C1512IFAA	C2024IFA	C2224T2AB			C1512IFAA	C1524IFAB		C2024T2C
	C1512T2AA	C2024T2A	C2028IFB			C1512T2AA	C1524T2AB		C2028IFC
	C1012IFAB	C1024IFAB	C2224IFB			C1012IFAB	C2024IFAB		C2224IFC
	C1012T2AB	C1024T2AB	C2224T2B			C1012T2AB	C2024IFAB		C2224T2C
	C1512IFAB	C1524IFAB	C2028IFC			C1512IFAB	C2024IFB		
	C1512T2AB	C1524T2AB	C2224IFC			C1512T2AB	C2024T2B		
	C1512IFB	C2024IFAB	C2224T2C			C1512IFB	C2028IF		
	C1512T2B	C2024T2AB				C1512T2B	C2028T2		
	C1512IFC	C2024IFB				C1024IF	C2224IF		
	C1512T2C	C2024T2B				C1024T2	C2224T2		
		C2024IFC				C1524IF	C2028IFA		
		C2024T2C				C1524T2	C2028T2A		
THERMOSTAT		THERMAL FUSE							
									
410130001	5813-2090-000	4520-2030-000							
C1012T2	C1012T2AB	C1012IFAA	C1512IFB						
C1512T2	C1512T2AB	C1012T2AA	C1512T2B						
C1012T2A	C1512T2B	C1512IFAA	C2024IFB						
C1512T2A	C1512T2C	C1512T2AA	C2024T2B						
C1012T2AA	C1024T2AB	C1012IFAB	C2028IFB						
C1512T2AA	C1524T2AB	C1012T2AB	C2224IFB						
C1024T2	C2024T2AB	C1512IFAB	C2224T2B						
C1524T2	C2024T2B	C1512T2AB	C1512IFC						
C2024T2	C2024T2C	C1024IFAB	C1512T2C						
C1024T2A	C2224T2AB	C1024T2AB	C2024IFC						
C1524T2A	C2224T2B	C1524IFAB	C2024T2C						
C2024T2A	C2224T2C	C1524T2AB	C2028IFC						
C2028T2		C2024IFAB	C2224IFC						
C2224T2		C2024T2AB	C2224T2C						
C2028T2A		C2024IFB							
C2224T2A		C2024T2B							
		C2028IFAB							
		C2224IFAB							
		C2224T2AB							
									

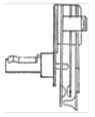
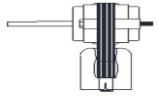
BVP					
MOTOR				LIMIT	
					
42528-052-01		42528-052-02		4520-2025-000	
VP1222	VP1222I	VP2022	VP2022I	VP1222C	VP2022IC
VP1222A	VP1222IB	VP2022A	VP2022IB	VP1222CNW	VP2022ICNW
VP1222AI	VP1222IBP	VP2022AI	VP2022IBP	VP1222IC	VP2422C
VP1222B	VP1222IC	VP2022B	VP2022IC	VP1222ICNW	VP2422CNW
VP1222C	VP1222ICNW	VP2022C	VP2022ICNW	VP2022C	VP2422IC
VP1222CNW		VP2022CNW		VP2022CNW	VP2422ICNW

A2500					
THERMOSTAT	ELEMENT	LIMIT	THERMAL FUSE	GRILLE	MOTOR
				PICTURE NOT AVAILABLE	
1230-8232	6101-8752	8541-8056	8671-8037	8683-8272	8767-8036
A2515T	A2530T	A2515T	A2515T	A2515T	A2515T
A2520T		A2520T	A2520T	A2520T	A2520T
A2530T		A2530T	A2530T	A2530T	A2530T
A2540T		A2540T	A2540T	A2540T	A2540T
A2548T		A2548T	A2548T	A2548T	A2548T

SCH SERIES						
ELEMENT						
						
302023801	302023802	302023803	302023804	302023805	302023806	302023807
SCH1012IF	SCH1512IF	SCH1527IF	SCH2020IF	SCH2024IF	SCH2027IF	SCH2012IF
SCH1012W	SCH1512W	SCH1527W	SCH2020W	SCH2024W	SCH2027W	SCH2012W
MOTOR			BLADE	FAN DELAY	LIMIT	
						
490062001	490062002	490062003	490062004	490061001	410074000	410169001
SCH1012IF	SCH2020IF	SCH2024IF	SCH1527IF	ALL MODELS	ALL MODELS	ALL MODELS
SCH1012W	SCH2020W	SCH2024W	SCH1527W			
SCH1512IF			SCH2027IF			
SCH1512W			SCH2027W			
SCH2012IF						
SCH2012W						

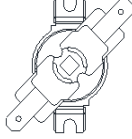
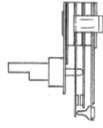
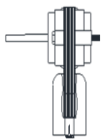
1235 & 2435 SERIES (OBS)					
SCREEN		KNOB	FACE PLATE	LIMIT	
					
1235-0037 1235 2435	8850-8046 1235P 2435P	3301-2047-000 ALL MODELS	4503-2094-000 ALL MODELS	8541-8054 ALL MODELS	
THERMOSTAT	MOTOR	FAN BLADE	ELEMENT	THERMAL FUSE	
					
1230-8194 ALL MODELS	1235-0007 ALL MODELS	1235-0008 ALL MODELS	6101-8741 ALL MODELS	8671-8036 2435 2435P	

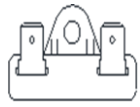
B2400 SERIES (OBS)			
ELEMENT		LIMIT	THERMOSTAT
			
6101-8741 B2451	6101-8742 B2452	8541-8055 ALL MODELS	1230-8206 ALL MODELS
MOTOR		FAN BLADE	THERMAL FUSE
			
8767-8035 B2451	8767-8036 B2452	991-313 ALL MODELS	8671-8037 B2452

SR SERIES (OBSOLETE)

ELEMENT



302023801 SR1012IFLTC SR1012IFLTP SR1012IFLTPB SR1012IFP SR1012LTC SR1012LTP SR1012LTPB SR1012P	302023802 SR1512CKJCP SR1512IFLTC SR1512IFLTP SR1512IFLTPB SR1512IFP SR1512IFPB SR1512LTC SR1512LTP SR1512LTPB SR1512P	302023803 SR1527IFLTC SR1527IFLTP SR1527IFLTPB SR1527IFP SR1527IFPB SR1527LTC SR1527LTP SR1527LTPB SR1527P	302023804 SR2020IFLTC SR2020IFLTP SR2020IFLTPB SR2020IFP SR2020LTC SR2020LTP SR2020LTPB SR2020P	302023805 SR2024IFLTC SR2024IFLTP SR2024IFLTPB SR2024IFP SR2024LTC SR2024LTP SR2024LTPB SR2024P	302023806 SR2027IFLTC SR2027IFLTP SR2027IFLTPB SR2027IFP SR2027LTC SR2027LTP SR2027LTPB SR2027P	302023807 SR2012IFLTC SR2012IFLTP SR2012IFLTPB SR2012IFP SR2012LTC SR2012LTP SR2012LTPB SR2012P
--	---	--	--	--	--	--

KNOB



THERMOSTAT



FAN DELAY



SR1012C SR1012IFC SR1012IFP SR1012IFPB SR1012P SR1012PB SR1512C SR1512CKJCP SR1512IFC SR1512IFP SR1512IFPB SR1512P SR1512PB SR1527C SR1527IFC	3301-2020-008 SR1527IFP SR1527IFPB SR1527P SR1527PB SR2012C SR2012IFC SR2012IFP SR2012IFPB SR2012P SR2012PB SR2020C SR2020IFC SR2020IFP SR2020IFPB SR2020P	SR2020PB SR2024C SR2024IFC SR2024IFP SR2024IFPB SR2024P SR2024PB SR2027C SR2027IFC SR2027IFP SR2027IFPB SR2027P SR2027PB	SR1012C SR1012IFC SR1012IFP SR1012IFPB SR1012P SR1012PB SR1512C SR1512CKJCP SR1512IFC SR1512IFP SR1512IFPB SR1512P SR1512PB SR1527C SR1527IFC	5813-2027-000 SR1527IFP SR1527IFPB SR1527P SR1527PB SR2012C SR2012IFC SR2012IFP SR2012IFPB SR2012P SR2012PB SR2020C SR2020IFC SR2020IFP SR2020IFPB SR2020P	SR2020PB SR2024C SR2024IFC SR2024IFP SR2024IFPB SR2024P SR2024PB SR2027C SR2027IFC SR2027IFP SR2027IFPB SR2027P SR2027PB	410074000 ALL MODELS
---	--	--	---	--	--	--------------------------------

BLADE





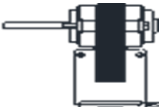





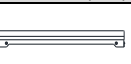

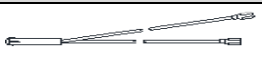

MOTOR













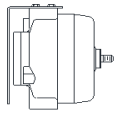
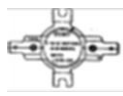





SR1012IFLTC SR1012IFLTP SR1012IFLTPB SR1012IFP SR1012LTC SR1012LTP SR1012LTPB SR1012P SR1512CKJCP SR1512IFLTC SR1512IFLTP SR1512IFLTPB SR1512IFP SR1512LTC SR1512LTP SR1512LTPB SR1512P SR1527IFLTC SR1527IFLTP SR1527IFLTPB SR1527IFP SR1527LTC	490061001 SR1527LTP SR1527LTPB SR1527P SR2012IFLTC SR2012IFLTP SR2012IFLTPB SR2012IFP SR2012LTC SR2012LTP SR2012LTPB SR2012P SR2012PB SR2020IFC SR2020IFP SR2020IFPB SR2020P	SR2024IFP SR2024LTC SR2024LTP SR2024LTPB SR2024P SR2027IFLTC SR2027IFLTP SR2027IFLTPB SR2027IFP SR2027LTC SR2027LTP SR2027LTPB SR2027P	SR1012IFLTC SR1012IFLTP SR1012IFLTPB SR1012IFP SR1012LTC SR1012LTP SR1012LTPB SR1012P SR1512CKJCP SR1512IFLTC SR1512IFLTP SR1512IFLTPB SR1512IFP	490062001 SR1512LTC SR1512LTP SR1512LTPB SR1512P SR2012IFLTC SR2012IFLTP SR2012IFLTPB SR2012IFP SR2012LTC SR2012LTP SR2012LTPB SR2012P	490062002 SR2020IFLTC SR2020IFLTP SR2020IFLTPB SR2020IFP SR2020LTC SR2020LTP SR2020LTPB SR2020P	490062003 SR2024IFLTC SR2024IFLTP SR2024IFLTPB SR2024IFP SR2024LTC SR2024LTP SR2024LTPB SR2024P	490062004 SR1527IFLTC SR1527IFLTP SR1527IFLTPB SR1527IFP SR1527LTC SR1527LTP SR1527LTPB SR1527P SR2027IFLTC SR2027IFLTP SR2027IFLTPB SR2027IFP SR2027LTC SR2027LTP SR2027LTPB SR2027P
---	---	--	--	---	--	--	--

SRA SERIES WALL HEATER (OBS)











SRA SERIES WALL HEATER (OBS)									
GRILLE	PLASTIC COVER(2REQ)	KNOB	FAN BLADE	LIGHT				THERMAL FUSE	
									
1402-2117-001 ALL MODELS	1402-2119-000 ALL MODELS	3301-2014-001 ALL MODELS	490061001 ALL MODELS	3510-2008-003 SRA1012B SRA1512B SRA1812B SRA1012DSB SRA1512DSB SRA1812DSB	3510-2008-002 SRA1527B SRA2020B SRA2024B SRA2027B SRA1527DSB SRA2020DSB SRA2024DSB SRA2027DSB	3510-2008-006 SRA1012DSC SRA1512DSC SRA1812DSC	3510-2008-007 SRA1527DSC SRA2020DSC SRA2024DSC SRA2027DSC	4520-2030-000 SRA1012DSC SRA1512DSC SRA1527DSC SRA1812DSC SRA2020DSC SRA2024DSC SRA2027DSC	
THERMOSTAT		MANUAL LIMIT	DISCONNECT SW.	FAN DELAY		HI LIMIT			
									
5813-2001-000		5813-2022-000	4520-11016-000	410170001	410074000		410143000		
SRA1012 SRA1012IF SRA1012A SRA1012B SRA1012DS SRA1012DSB SRA1012DSC SRA1512 SRA1512IF SRA1512A SRA1512B SRA1512DS SRA1512DSB SRA1512DSC SRA1527 SRA1527IF SRA1527A SRA1527B SRA1527DS SRA1527DSB SRA1527DSC	SRA1812DSC SRA2020 SRA2020IF SRA2020A SRA2020B SRA2020DSB SRA2020DSC SRA2024 SRA2024IF SRA2024A SRA2024B SRA2024DS SRA2024DSB SRA2024DSC SRA2027 SRA2027A SRA2027B SRA2027DS SRA2027DSB SRA2027DSC	SRA1812 SRA1812IF SRA1812A SRA1812B SRA1812DSB	SRA1012A SRA1512A SRA1527A SRA1812A SRA2020A SRA2024A SRA2027A SRA1012DS SRA1512DS SRA2024DS SRA1527DSC SRA1812DSC SRA2020DSC SRA2024DSC SRA1527DSC SRA2027DSC SRA2027DS SRA2024DSC SRA2027DSC	SRA1012DS SRA1012DSB SRA1012DSC SRA1512DS SRA1512DSB SRA1512DSC SRA1527DSB SRA1527DSC SRA1812DSB SRA1512DSC SRA1527DSC SRA1527IF SRA1527B SRA1527DSC SRA1527DS SRA1527DSB SRA1812IF SRA1812IF	SRA1012 SRA1812B SRA1012IF SRA1012B SRA1012DSB SRA2020 SRA2020IF SRA1512 SRA2020B SRA1512IF SRA2024 SRA2024IF SRA1527 SRA2024B SRA2024DSB SRA2024DSC SRA2027 SRA2027B SRA2027DSB SRA2027DSC	SRA1012 SRA1512 SRA1527 SRA1812 SRA2020 SRA2024 SRA2027 SRA1012IF SRA1512IF SRA1527IF SRA1812IF SRA2020IF SRA2024IF	SRA1012B SRA1512B SRA1527B SRA1812B SRA2020B SRA2024B SRA2027B SRA1012DSB SRA1512DSB SRA1527DSB SRA1812DSB SRA2020DSB SRA2024DSB SRA2027DSB		
MOTOR				ELEMENT					
									
490062001 SRA1012 SRA1512 SRA1812 SRA1012IF SRA1512IF SRA1812IF SRA1012A SRA1812A SRA1512B SRA1812B SRA1012DS SRA1512DS SRA1012DSB SRA1512DSB SRA1812DSB SRA1012DSC SRA1512DSC SRA1812DSC	490062002 SRA2020 SRA2020IF SRA2020A SRA2020B SRA2020DSB SRA2020DSC	490062003 SRA2024 SRA2024IF SRA2024A SRA2024B SRA2024DS SRA2024DSC	490062004 SRA1527 SRA2027 SRA1527IF SRA1527A SRA2027A SRA1527B SRA2027B SRA2027DS SRA1527DSB SRA2027DSB SRA1527DSC SRA2027DSC	302023801 SRA1012 SRA1012IF SRA1012A SRA1012B SRA1012DS SRA1012DSB SRA1012DSC 302023802 SRA1512 SRA1512IF SRA1512A SRA1512B SRA1512DS SRA1512DSB	302023803 SRA1527 SRA1527IF SRA1527A SRA1527B SRA1527DSB SRA1527DSC 302023808 SRA1812 SRA1812IF SRA1812A SRA1812B SRA1812DSB SRA1812DSC 302023806 SRA2027 SRA2027A SRA2027B SRA2027DS SRA2027DSB SRA2027DSC	302023804 SRA2020 SRA2020IF SRA2020A SRA2020B SRA2020DSB SRA2020DSC 302023805 SRA2024 SRA2024IF SRA2024A SRA2024B SRA2024DS SRA2024DSB SRA2024DSC			

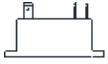







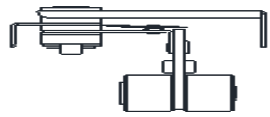

FR SERIES (OBSOLETE)

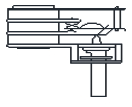
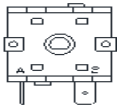
ELEMENT					THERMOSTAT				
									
302015806 FR1527 FR1527A FR1527AIF FR1527IF FR1527LT FR1527LTIF FR1527LTPB FR1527PB	302015801 FR2020 FR2020A FR2020AIF FR2020IF FR2020LT FR2020LTIF FR2020LTPB FR2020PB	302015802 FR2024 FR2024A FR2024AIF FR2024IF FR2024LT FR2024LTIF FR2024LTPB FR2024PB	302015803 FR2027 FR2027A FR2027AIF FR2027IF FR2027LT FR2027LTIF FR2027LTPB FR2027PB	302012806 FR3027 FR3027A FR3027AIF FR3027IF FR3027LT FR3027LTIF FR3027LTPB FR3027PB	FR1527 FR1527A FR1527AIF FR1527IF FR1527PB FR2020 FR2020A FR2020AIF FR2020IF FR2020PB FR2024 FR2024A FR2024AIF FR2024IF FR2024PB FR2027 FR2027A	410168002 FR2027AIF FR2027IF FR2027PB FR3027 FR3027A FR3027AIF FR3027IF FR4020 FR4020A FR4020AIF FR4020IF FR4020PB FR4024 FR4024A FR4024AIF FR4024IF FR4024PB FR4027A FR4027AIF FR4027IF FR4027PB FR4824 FR4824A FR4824AIF FR4824IF FR4824PB FR4827A FR4827AIF FR4827IF FR4827PB FR4827PB	FR4024PB FR4027 FR4027A FR4027AIF FR4027IF FR4027PB FR4824 FR4824A FR4824AIF FR4824IF FR4824PB FR4827A FR4827AIF FR4827IF FR4827PB		
302012807 FR4020 FR4020A FR4020AIF FR4020IF FR4020LT FR4020LTIF FR4020LTPB FR4020PB	302012808 FR4024 FR4024A FR4024AIF FR4024IF FR4024LT FR4024LTIF FR4024LTPB FR4024PB	302012809 FR4027 FR4027A FR4027AIF FR4027IF FR4027LT FR4027LTIF FR4027LTPB FR4027PB	302012810 FR4824 FR4824A FR4824AIF FR4824IF FR4824LT FR4824LTIF FR4824LTPB FR4824PB	302012811 FR4827 FR4827A FR4827AIF FR4827IF FR4827LT FR4827LTIF FR4827LTPB FR4827PB	FR2020AIF FR2020IF FR2020PB FR2024 FR2024A FR2024AIF FR2024IF FR2024PB FR2027 FR2027A	FR4020 FR4020A FR4020AIF FR4020IF FR4020PB FR4024 FR4024A FR4024AIF FR4024IF FR4024PB FR4027A FR4027AIF FR4027IF FR4027PB FR4824 FR4824A FR4824AIF FR4824IF FR4824PB FR4827A FR4827AIF FR4827IF FR4827PB	FR4824AIF FR4824IF FR4824PB FR4827A FR4827AIF FR4827IF FR4827PB		
MOTOR					LIMIT	FAN DELAY			
									
490064001 FR2020 FR2020IF FR2020LT FR2020LTIF FR2020LTPB FR2020PB FR2024 FR2024IF FR2024LT FR2024LTIF FR2024LTPB FR2024PB FR4020 FR4020IF FR4020LT		490064003 FR1527 FR1527IF FR1527LT FR1527LTIF FR1527LTPB FR1527PB FR2027 FR2027IF FR2027LT FR2027LTIF FR2027LTPB FR2027PB FR4824 FR4824IF FR4824LT FR4824LTIF FR4824LTPB FR4824PB FR3027 FR3027IF FR3027LT		3900-2002-502 FR2020A FR2020AIF FR2024A FR2024AIF FR4020A FR4020AIF FR4024A FR4024AIF FR4824A FR4824AIF		3900-2002-503 FR1527A FR1527AIF FR2027A FR2027AIF FR3027A FR3027AIF FR4027A FR4027AIF FR4827A FR4827AIF		410169001 ALL MODELS BLADE  490030103 ALL MODELS	410074000 ALL MODELS

FRA SERIES WALL HEATER (OBSOLETE)												
GRILLE		ELEMENT				RELAY						
												
1402-2241-001		302012806	302012809	302015801	302015806	1802-2075-800	5018-2017-004	5018-2017-000				
FRA2020B	FRA4024B	FRA3027	FRA4027	FRA2020	FRA1527	FRA40203	FRA40203	FRA40243				
FRA2024B	FRA40243B	FRA3027A	FRA4027A	FRA2020A	FRA1527A	FRA40203B	FRA4820	FRA48243				
FRA2027B	FRA4027B	FRA3027B	FRA4027B	FRA2020B	FRA1527B	1802-2075-801	FRA48203	FRA40243B				
FRA1512	FRA4820B	302012807	302012811	302015802	302012827	FRA4820	FRA48203	FRA48243B				
FRA1812	FRA48203B	FRA4020	FRA4827	FRA2024	FRA1512	FRA48203	FRA48203B					
FRA3027B	FRA4824B	FRA4020A	FRA4827A	FRA2024A	302012828	FRA4820B	FRA48203B					
FRA4020B	FRA48243B	FRA4020B	FRA4827B	FRA2024B	FRA1812	FRA48203B						
FRA40203B	FRA4827B	FRA4020T2	302012810	FRA2024T2		1802-2075-802						
		FRA4020T2A	FRA4824	FRA2024T2A		FRA40243						
		302012808	FRA4824A	302015803		FRA40243B						
		FRA4024	FRA4824B	FRA2027		1802-2075-803						
		FRA4024A	FRA4824T2	FRA2027A		FRA48243B						
		FRA4024B	FRA4824T2A	FRA2027B								
		FRA4024T2										
		FRA4024T2A										
MANUAL LIMIT		HI LIMIT		MOTOR		FAN DELAY						
												
4520-2027-000		410169001		3900-2002-501	3900-2002-500	3900-2002-518	4520-2024-000		410074000			
FRA40203	FRA2027B	FRA1527	FRA1527	FRA1527	FRA2020	FRA40203	FRA40203	FRA3027A	FRA4824			
FRA40243	FRA1512	FRA2020	FRA2020	FRA2024	FRA2024	FRA40243	FRA40243	FRA3027B	FRA4824A			
FRA4820	FRA1812	FRA2024	FRA2024	FRA4020	FRA4020	FRA4820	FRA4820	FRA4020	FRA4824B			
FRA48203	FRA3027B	FRA2027	FRA2027	FRA4024	FRA4024	FRA48203	FRA48203	FRA4020A	FRA4824T2A			
FRA48243	FRA4020B	FRA4027	FRA4027	FRA4824	FRA4824	FRA48243	FRA48243	FRA4020B	FRA4827			
FRA1527A	FRA40203B	FRA4020	FRA4020	FRA2024T2	FRA2024T2	FRA40203B	FRA40203B	FRA4020T2	FRA4827			
FRA2020A	FRA4024B	FRA4024	FRA4024	FRA2020A	FRA2020A	FRA40243B	FRA40243B	FRA2024	FRA4027A			
FRA2024A	FRA40243B	FRA4027	FRA4027	FRA2024A	FRA2024A	FRA4820B	FRA4820B	FRA4024A	FRA4827B			
FRA2027A	FRA4027B	FRA4824	FRA4824	FRA2024B	FRA2024B	FRA48203B	FRA48203B	FRA2024B	FRA1512			
FRA3027A	FRA4820B	FRA4827	FRA4827	FRA4024A	FRA4024A	3900-2010-001		FRA2024T2	FRA4024B			
FRA4020A	FRA48203B	FRA2024T2	FRA2024T2	FRA1527	FRA1527	FRA40203	3900-2010-003	FRA2024T2A	FRA4024T2			
FRA4024A	FRA4824B	FRA2020B	FRA2020B	FRA2027A	FRA2027A	FRA1512	FRA1512	FRA4024T2A	FRA4027			
FRA4027A	FRA48243B	FRA2024B	FRA2024B	FRA3027A	FRA3027A	FRA1812	FRA1812	FRA4027A	FRA4027B			
FRA4824A	FRA4827B	FRA4020B	FRA4020B	FRA4027A	FRA4027A			FRA4027B	FRA4027A			
FRA4827A	FRA2024T2A	FRA4024B	FRA4024B	FRA4827A	FRA4827A			FRA4027B	FRA4027B			
FRA1527B	FRA4020T2A	FRA4824B	FRA4824B	FRA1527B	FRA1527B							
FRA2020B	FRA4024T2A	FRA2020T2A	FRA2020T2A	FRA2027B	FRA2027B							
FRA2024B	FRA4824T2A	FRA2024T2A	FRA2024T2A	FRA3027B	FRA3027B							
		FRA4024T2A	FRA4024T2A	FRA4027B	FRA4027B							
		FRA4824T2A	FRA4824T2A	FRA4827B	FRA4827B							
THERMOSTAT		DISCONNECT SWITCH				FAN BLADE		PLASTIC COVER(2REQ)		KNOB		
												
410168002	5813-2059-000	5813-2027-000		5216-2019-000		410170001				490030103	1402-2120-000	3301-2014-001
FRA1527	FRA1527B	FRA2024T2	FRA2024T2	FRA40203	FRA40203	FRA1527	FRA1527B	ALL MODELS		ALL MODELS		
FRA2020	FRA2020B	FRA4020T2	FRA4020T2	FRA40243	FRA40243	FRA2020	FRA2020B	ALL MODELS		ALL MODELS		
FRA2024	FRA2024B	FRA4024T2	FRA4024T2	FRA4820	FRA4820	FRA2024	FRA2024B	ALL MODELS		ALL MODELS		
FRA2027	FRA2027B	FRA4824T2	FRA4824T2	FRA48203	FRA48203	FRA2027	FRA2027B	ALL MODELS		ALL MODELS		
FRA3027	FRA1512	FRA2024T2A	FRA2024T2A	FRA48243	FRA48243	FRA3027	FRA1512	ALL MODELS		ALL MODELS		
FRA4020	FRA1812	FRA4020T2A	FRA4020T2A	FRA40203B	FRA40203B	FRA4020	FRA1812	ALL MODELS		ALL MODELS		
FRA40203	FRA3027B	FRA4024T2A	FRA4024T2A	FRA40243B	FRA40243B	FRA4024	FRA3027B	ALL MODELS		ALL MODELS		
FRA4024	FRA4020B	FRA4824T2A	FRA4824T2A	FRA4820B	FRA4820B	FRA4027	FRA4020B	ALL MODELS		ALL MODELS		
FRA40243	FRA40203B			FRA48203B	FRA48203B	FRA4824	FRA4024B	ALL MODELS		ALL MODELS		
FRA4027	FRA4024B			FRA48243B	FRA48243B	FRA4827	FRA4027B	ALL MODELS		ALL MODELS		
FRA4820	FRA40243B					FRA1527A	FRA4824B	ALL MODELS		ALL MODELS		
FRA48203	FRA4027B					FRA2020A	FRA4827B	ALL MODELS		ALL MODELS		
FRA4824	FRA4820B					FRA2024A	FRA2024T2	ALL MODELS		ALL MODELS		
FRA48243	FRA48203B					FRA2027A	FRA4020T2	ALL MODELS		ALL MODELS		
FRA4827	FRA4824B					FRA3027A	FRA4024T2	ALL MODELS		ALL MODELS		
FRA1527A	FRA48243B					FRA4020A	FRA4824T2	ALL MODELS		ALL MODELS		
FRA2020A	FRA4827B					FRA4024A	FRA2024T2A	ALL MODELS		ALL MODELS		
FRA2024A						FRA4027A	FRA4020T2A	ALL MODELS		ALL MODELS		
FRA2027A						FRA4824A	FRA4024T2A	ALL MODELS		ALL MODELS		
FRA3027A						FRA4827A	FRA4824T2A	ALL MODELS		ALL MODELS		
FRA4020A								ALL MODELS		ALL MODELS		
FRA4024A								ALL MODELS		ALL MODELS		
FRA4027A								ALL MODELS		ALL MODELS		
FRA4824A								ALL MODELS		ALL MODELS		
FRA4827A								ALL MODELS		ALL MODELS		

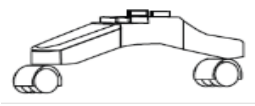

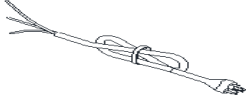



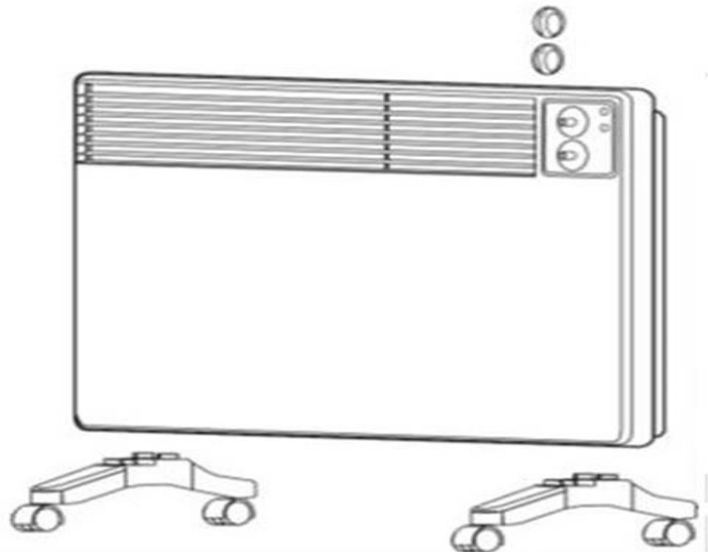



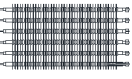

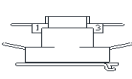

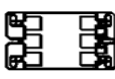

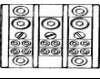

FRC SERIES (OBSOLETE)											
GRILLE				FAN DELAY				RELAY			
											
2501-2003-007				4520-2024-000				410074000		5018-2017-004	5018-2017-000
FRC40203	FRC2027AIF	FRC4827AIF	FRC2020C	FRC40203	FRC1527	FRC1527B	FRC1527A	FRC40203	FRC40243		
FRC40243	FRC3027A	FRC1527B	FRC2024C	FRC40243	FRC1527IF	FRC2027B	FRC1527AIF	FRC4820	FRC48243		
FRC4820	FRC3027AIF	FRC2020B	FRC2027C	FRC4820	FRC2027	FRC3027B	FRC3027A	FRC48203	FRC40243C		
FRC48203	FRC4020A	FRC2024B	FRC3027C	FRC48203	FRC2027IF	FRC4027B	FRC3027AIF	FRC40203C	FRC48243C		
FRC48243	FRC4020AIF	FRC2027B	FRC4020C	FRC48243	FRC3027	FRC4827B	FRC4027A	FRC4820C			
FRC1527A	FRC4024A	FRC3027B	FRC40203C	FRC40203C	FRC3027IF	FRC1527C	FRC4027AIF	FRC48203C			
FRC1527AIF	FRC4024AIF	FRC4020B	FRC4024C	FRC40243C	FRC4027	FRC2027C	FRC4827A				
FRC2020A	FRC4027A	FRC4024B	FRC40243C	FRC4820C	FRC4027IF	FRC3027C	FRC4827AIF				
FRC2020AIF	FRC4027AIF	FRC4027B	FRC4027C	FRC48203C	FRC4827	FRC4027C	FRC2020A				
FRC2024A	FRC4824A	FRC4824B	FRC4820C	FRC48243C	FRC4827IF	FRC4827C	FRC2020AIF				
FRC2024AIF	FRC4824AIF	FRC4827B	FRC48203C		FRC2020	FRC2020B	FRC2024A				
FRC2027A	FRC4827A	FRC1527C	FRC4824C		FRC2020IF	FRC2024B	FRC2024AIF				
			FRC48243C		FRC4020	FRC4020B	FRC4020A				
			FRC4827C		FRC4020IF	FRC4024B	FRC4020AIF				
					FRC2024	FRC4824B	FRC4024A				
					FRC2024IF	FRC2020C	FRC4024AIF				
					FRC4024	FRC2024C	FRC4824A				
					FRC4024IF	FRC4020C	FRC4824AIF				
					FRC4824	FRC4024C					
					FRC4824IF	FRC4824C					
ELEMENTS				MOTOR				FAN BLADE	THERMOSTAT		
											
302015806	302015801	302015802	302015803	490064003	3900-2010-001	3900-2002-501	3900-2002-518	490030103	410168002		
FRC1527	FRC2020	FRC2024	FRC2027	FRC1527	FRC1527B	FRC1527A	FRC40203	ALL MODELS	ALL MODELS		
FRC1527IF	FRC2020IF	FRC2024IF	FRC2027IF	FRC1527IF	FRC2027B	FRC1527AIF	FRC40243				
FRC1527A	FRC2020A	FRC2024A	FRC2027A	FRC2027	FRC3027B	FRC3027A	FRC4820				
FRC1527AIF	FRC2020AIF	FRC2024AIF	FRC2027AIF	FRC2027IF	FRC4027B	FRC3027AIF	FRC48203				
FRC1527B	FRC2020B	FRC2024B	FRC2027B	FRC3027	FRC4827B	FRC4027A	FRC48243				
FRC1527C	FRC2020C	FRC2024C	FRC2027C	FRC3027IF	FRC1527C	FRC4027AIF	FRC40203C				
				FRC4027	FRC2027C	FRC4827A	FRC40243C				
				FRC4027IF	FRC3027C	FRC4827AIF	FRC4820C				
				FRC4827	FRC4027C	3900-2002-500	FRC48203C				
				FRC4827IF	FRC4827C	FRC2020A	FRC48243C				
				490064001	3900-2010-000	FRC2020AIF	490064002				
				FRC2020	FRC2020B	FRC2024A	FRC2024				
				FRC2020IF	FRC2024B	FRC2024AIF	FRC2024IF				
				FRC4020	FRC4020B	FRC4020A	FRC4024				
				FRC4020IF	FRC4024B	FRC4020AIF	FRC4024IF				
					FRC4824B	FRC4024A	FRC4824				
					FRC2020C	FRC4024AIF	FRC4824IF				
					FRC2024C	FRC4824A					
					FRC4020C	FRC4824AIF					
					FRC4024C						
					FRC4824C						
DISCONNECT SWITCH				MANUAL LIMIT				HI LIMIT			
											
5216-2019-000	410170001			4520-2027-000				410169001			
FRC40203	FRC1527	FRC2020B	FRC2024A	FRC2027	FRC1527B	FRC2020C	FRC1527	FRC4027	FRC2027		
FRC40243	FRC1527IF	FRC2020C	FRC2024AIF	FRC2027IF	FRC2027B	FRC2024C	FRC1527IF	FRC4027IF	FRC2027IF		
FRC4820	FRC1527A	FRC4020	FRC2024B	FRC2027A	FRC3027B	FRC4020C	FRC1527A	FRC4027A	FRC2027A		
FRC48203	FRC1527AIF	FRC4020IF	FRC2024C	FRC2027AIF	FRC4027B	FRC4024C	FRC1527AIF	FRC4027AIF	FRC2027AIF		
FRC48243	FRC1527B	FRC4020A	FRC4824	FRC2027B	FRC4827B	FRC4824C	FRC3027	FRC2024	FRC4024		
FRC40203C	FRC1527C	FRC4020AIF	FRC4824IF	FRC2027C	FRC2020B	FRC40203	FRC3027IF	FRC2024IF	FRC4024IF		
FRC40243C	FRC3027	FRC4020B	FRC4824A	FRC4024	FRC2024B	FRC40243	FRC3027A	FRC2024A	FRC4024A		
FRC4820C	FRC3027IF	FRC4020C	FRC4824IFA	FRC4024IF	FRC4020B	FRC4820	FRC3027AIF	FRC2024AIF	FRC4024AIF		
FRC48203C	FRC3027A	FRC4027	FRC4824B	FRC4024A	FRC4024B	FRC48203	FRC2020	FRC4824			
FRC48243C	FRC3027AIF	FRC4027IF	FRC4824C	FRC4024AIF	FRC4824B	FRC48243	FRC2020IF	FRC4824IF			
	FRC3027B	FRC4027A	FRC4827	FRC4024B	FRC1527C	FRC40203C	FRC2020A	FRC4824A			
	FRC3027C	FRC4027AIF	FRC4827IF	FRC4024C	FRC2027C	FRC40243C	FRC2020AIF	FRC4824IFA			
	FRC2020	FRC4027B	FRC4827A		FRC3027C	FRC4820C	FRC4020	FRC4827			
	FRC2020IF	FRC4027C	FRC4827IFA		FRC4027C	FRC48203C	FRC4020IF	FRC4827IF			
	FRC2020A	FRC2024	FRC4827B		FRC4827C	FRC48243C	FRC4020A	FRC4827A			
	FRC2020AIF	FRC2024IF	FRC4827C				FRC4020AIF	FRC4827IFA			

WPC SERIES (OBSOLETE)			
ELEMENT	TIP OVER SW.	LIMIT	THERMOSTAT
			
1802-10822-000 WPC1500A	5216-11004-000 WPC1500A	410122002 WPC1500A	5813-2092-001 WPC1500A
1802-11017-000 (500W) 1802-11017-001 (1000W) WPC1500B WPC1500C		4520-11004-003 WPC1500B WPC1500C	WPC1500B WPC1500C
4 POSITION SW.	PORT SWITCH	LIGHT RED	PILOT LIGHT AMBER
			
5216-2071-000 WPC1500A WPC1500B WPC1500C	5216-2073-000 WPC1500A WPC1500B WPC1500C	3510-2021-002 WPC1500A 3510-2021-004 WPC1500B WPC1500C	3510-11518-000 WPC1500A WPC1500B WPC1500C
WHEEL KIT (2 REQ)	HOLE PLUG (2 REQ)	CORD	KNOB (2 REQ)
			
1205-10305-000 WPC1500A WPC1500B WPC1500C	4506-2022-000 WPC1500A WPC1500B WPC1500C	1420-2029-009 WPC1500A WPC1500B WPC1500C	3301-2058-000 WPC1500A WPC1500B WPC1500C

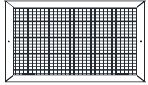

TBX SERIES (OBS)







ELEMENT	MOTOR	TIME DELAY RELAY	CONTACTOR 30AMP	CONTACTOR 50AMP	THERMOSTAT
					
302006814 TBX754	490059004 ALL MODELS	410171003 ALL MODELS	5018-0003-002 ALL MODELS	5018-0006-002 ALL MODELS	5813-2059-000 ALL MODELS
302006813 TBX104					
BLADE	HI LIMIT	TERMINAL BLOCK	TOOL BOX COVER	CORD	KNOB
					
490011001 ALL MODELS	410169001 ALL MODELS	480100001 ALL MODELS	1016-0193-800 ALL MODELS	1016-10593-000 ALL MODELS	3301-2053-000 ALL MODELS
AXLE	GRILLE	COLLAPSABLE HANDLE	HANDLE	WHEEL (2 REQ)	AXLE CAP (2 REQ)
					
1017-0004-000 ALL MODELS	2501-10513-800 ALL MODELS	2710-10586-000 ALL MODELS	2710-2012-800 ALL MODELS	6406-0002-000 ALL MODELS	1408-10584-000 ALL MODELS





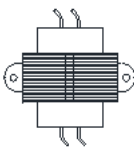

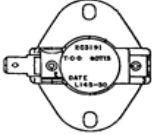
CUH OBSOLETE

DISCRIPTION	PART NUMBERS			
	CUH3	CUH4	CUH6	CUH7
FAN MOTOR: SINGLE SHAFT DOUBLE SHAFT	3900-2032-000*	- 3900-2033-000*	3900-2032-000 3900-2033-000	- 3900-2033-000**
POWER TRANSFORMER: 277V 480V	490015009 490015010	490015009 490015010	490015007 490015008	490015007 490015008
* ONE REQUIRED ** TWO REQUIRED				
CIRCUIT BREAKERS				
REPLACEMENT CIRCUIT BREAKERS, FOR HEATERS SO EQUIPPED, ARE STANDARD, OFF-THE-SHELF ITEMS INVENTORIED BY MOST ELECTRICAL DISTRIBUTORS.				







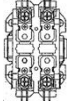
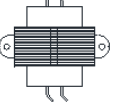

VUH & VUH-A

BLADE	RELAY		TRANSFORMER	
				
490020000	5018-0005-006		5018-0006-002	
H2520 H2524 H2548 H2555 H2560 H3020 H3024 H3048 H3055 H3060 H4020 H4024 H4048 H4055 H4060	H1020A H1024A H1027A H1034A H1048A H1055A H1060A H1520A H1524A H1527A H1534A	H1048A H1555A H1560A H2020 H2024 H2027 H2034 H2048 H2055 H2060	H2520 H2524 H2548 H2555 H3020 H3024 H3048 H3055 H4020 H4024 H4048 H4055 H5020 H5024 H5060	490015018 H1034A H1534A 490015019 H2034 490015021 H1060A H1560A 490015005 H2027 490015008 H5048 H5055 490015012 H2060 H2560 H3060 H4060 490015015 H5060
LIMIT	FAN DELAY	CAPACITOR		
				
410029000 ALL MODELS	410126000 ALL MODELS	1432-0002-003 ALL MODELS		

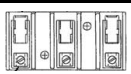

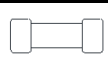



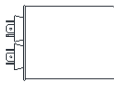



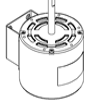
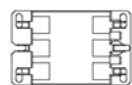
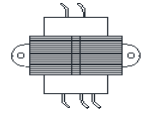

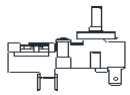
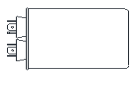
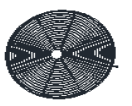
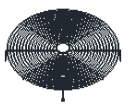

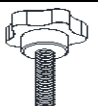
HUHAA SERIES

ELEMENT				MOTOR		
QUANTITY OF ELEMENTS 3 THRU 10KW (3) 15 THRU 30KW (6) 40 & 50KW (9)						
						
1802-0087-024 HUHAA320	1802-0087-031 HUHAA720 HUHAA1024	1802-0087-037 HUHAA1520 HUHAA2024	1802-0087-018 HUHAA3024	3900-2002-506 HUHAA320 HUHAA324 HUHAA520 HUHAA524	3900-0347-005 HUHAA748 HUHAA1048	3900-0363-500 HUHAA2548 HUHAA3048
1802-0087-000 HUHAA324	1802-0087-006 HUHAA724	1802-0087-012 HUHAA1524	1802-0087-019 HUHAA3048 HUHAA3048A	3900-0361-500 HUHAA1520 HUHAA1524	3900-0361-501 HUHAA1548	3900-2065-000 HUHAA2548A HUHAA3048A
1802-0087-001 HUHAA327	1802-0087-007 HUHAA727	1802-0087-008 HUHAA1548	1802-0087-020 HUHAA4024	3900-2002-507 HUHAA327 HUHAA527	3900-0362-002 HUHAA2020	3900-0350-002 HUHAA5020
1802-0087-002 HUHAA348	1802-0087-008 HUHAA748	1802-0087-026 HUHAA2020	1802-0087-021 HUHAA4048	3900-2005-000 HUHAA348 HUHAA548	3900-0362-000 HUHAA2024	3900-0350-000 HUHAA4024 HUHAA5024
1802-0087-034 HUHAA520	1802-0087-036 HUHAA1020	1802-0087-016 HUHAA2524	1802-0087-030 HUHAA5020	3900-2014-004 HUHAA720 HUHAA724	3900-0362-001 HUHAA2048	3900-0350-001 HUHAA4048 HUHAA5048
1802-0087-035 HUHAA524	1802-0087-010 HUHAA1027	1802-0087-017 HUHAA2548 HUHAA2548A	1802-0087-022 HUHAA5024	HUHAA727 HUHAA1020 HUHAA1024 HUHAA1027	3900-0364-000 HUHAA2524 HUHAA3020 HUHAA3024	
1802-0087-004 HUHAA527 HUHAA548	1802-0087-011 HUHAA1048 HUHAA2048	1802-0087-028 HUHAA3020	1802-0087-023 HUHAA5048			
FAN BLADE				PROTECTOR LIMIT		FAN DELAY
						
1210-2000-000 HUHAA320 HUHAA324 HUHAA327 HUHAA348 HUHAA520 HUHAA524 HUHAA527 HUHAA548	1210-0090-000 HUHAA720 HUHAA724 HUHAA727 HUHAA748 HUHAA1020 HUHAA1024 HUHAA1027 HUHAA1048	1210-0098-000 HUHAA2524 HUHAA2548 HUHAA2548A HUHAA3020 HUHAA3024 HUHAA3048 HUHAA3048A	4520-0011-000 HUHAA320 HUHAA324 HUHAA327 HUHAA348 HUHAA520 HUHAA524 HUHAA527 HUHAA548	4520-0011-001 HUHAA720 HUHAA724 HUHAA727 HUHAA748 HUHAA1020 HUHAA1024 HUHAA1027 HUHAA1048 HUHAA1520 HUHAA1524 HUHAA1548 HUHAA2020 HUHAA2024 HUHAA2048	4520-0011-002 HUHAA2524 HUHAA2548 HUHAA2548A HUHAA3020 HUHAA3024 HUHAA3048 HUHAA3048A HUHAA4024 HUHAA4048 HUHAA5020 HUHAA5024 HUHAA5048	4520-0010-000 ALL MODELS
	1210-0090-001 HUHAA1520 HUHAA1524 HUHAA1548	1210-11004-000 HUHAA4024 HUHAA4048 HUHAA5020 HUHAA5024 HUHAA5048				
	1210-0096-000 HUHAA2020 HUHAA2024 HUHAA2048					
RELAY				POWER TR		
						
5018-0003-000 HUHAA720 HUHAA724 HUHAA727 HUHAA1024 HUHAA1027	5018-0004-100 HUHAA348 HUHAA548 HUHAA748 HUHAA1020 HUHAA1048 HUHAA1548 HUHAA2048 HUHAA4048 HUHAA5048	5018-0005-004 HUHAA1520 HUHAA1524 HUHAA2020 HUHAA2524 HUHAA2548 HUHAA3024 HUHAA3048 HUHAA3048A HUHAA4024 HUHAA4048 HUHAA5024	5018-0006-000 HUHAA2024 HUHAA3020 HUHAA5020 HUHAA5048	5814-0003-000 HUHAA720 HUHAA724 HUHAA1020 HUHAA1024 HUHAA1520 HUHAA1524 HUHAA2020 HUHAA2024 HUHAA2524 HUHAA3020 HUHAA3024	5814-0003-002 HUHAA720 HUHAA724 HUHAA1048 HUHAA1548 HUHAA2048 HUHAA2548 HUHAA2548A HUHAA3048 HUHAA3048A HUHAA4048 HUHAA5048	490026007 HUHAA4024 HUHAA5020 HUHAA5024
				5814-0003-001 HUHAA727 HUHAA1027		

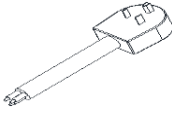

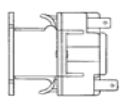

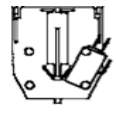
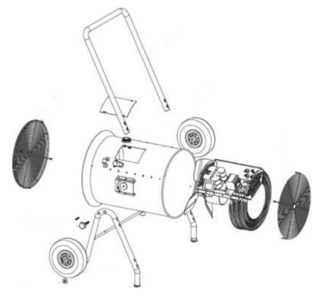
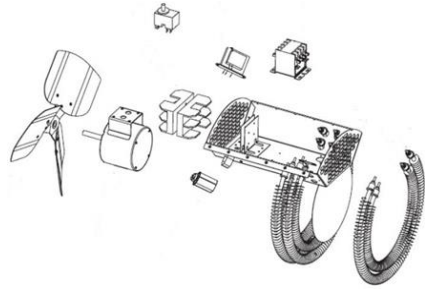
HUHAA CONTINUED

CONTROL BOARD			POWER BLOCK		FUSE BLOCK	FUSE	
							
5823-0001-000 HUHAA320 HUHAA324 HUHAA327 HUHAA520 HUHAA524 HUHAA527	5823-0002-000 HUHAA348 HUHAA548 HUHAA724 HUHAA727 HUHAA748 HUHAA1020 HUHAA1024 HUHAA1027 HUHAA1048 HUHAA1520 HUHAA1548		5823-0004-000 HUHAA320 HUHAA324 HUHAA327 HUHAA348 HUHAA520 HUHAA524 HUHAA527 HUHAA548 HUHAA720		5823-0004-001 HUHAA1524 HUHAA2548 HUHAA2548A HUHAA3048 HUHAA3048A 5823-0004-002 HUHAA2020 HUHAA2024 HUHAA2524 HUHAA4048 HUHAA5048 5823-0004-003 HUHAA1520 HUHAA3024 5823-0005-000 HUHAA3020 HUHAA4024 HUHAA5020 HUHAA5024	2025-0002-000 HUHAA1520 HUHAA2020 480030004 HUHAA2524 HUHAA3020 HUHAA3024 HUHAA4024 HUHAA5020 HUHAA5024 2025-0001-000 HUHAA5048 2025-7004-000 HUHAA5048	2019-0007-010 HUHAA1520 2019-0007-008 HUHAA2020 2019-7008-077 HUHAA2524 2019-7008-080 HUHAA3020 HUHAA5020 2019-7008-079 HUHAA3024 HUHAA5024 2019-7008-078 HUHAA4024 2019-7002-008 HUHAA5048 2019-7002-012 HUHAA5048
LOUVERS			LOUVER SPRING	HI/LOW SW.	CAPACITOR		
QUANTITY 3&5KW (5) 7 THRU 20KW (6) 25 THRU 50KW (9)							
3503-2004-106 HUHAA320 HUHAA324 HUHAA327 HUHAA348 HUHAA520 HUHAA524 HUHAA527 HUHAA548	3503-2004-101 HUHAA720 HUHAA724 HUHAA727 HUHAA748 HUHAA1020 HUHAA1024 HUHAA1027 HUHAA1048 HUHAA1520 HUHAA1548 HUHAA2020 HUHAA2024 HUHAA2048	3503-2004-108 HUHAA2524 HUHAA2548 HUHAA2548A HUHAA3020 HUHAA3024 HUHAA3048 HUHAA3048A HUHAA4024 HUHAA4048 HUHAA5020 HUHAA5024 HUHAA5048	5208-7005-001 ALL MODELS	5216-2053-000 HUHAA2524 HUHAA2548 HUHAA2548A HUHAA3020 HUHAA3024 HUHAA3048 HUHAA3048A HUHAA4024 HUHAA4048 HUHAA5020 HUHAA5024 HUHAA5048	1432-0002-003 HUHAA2020 HUHAA2024 HUHAA2048 HUHAA2524 HUHAA2548 1432-0002-001 HUHAA3020 HUHAA2548A HUHAA3048A 1432-0002-004 HUHAA4024 HUHAA4048 HUHAA5020 HUHAA5024 HUHAA5048		

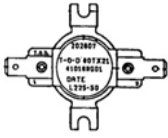
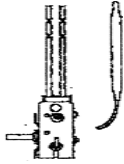
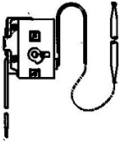
BDH SERIES

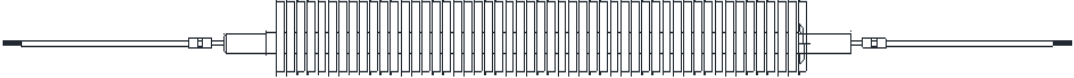
ELEMENT SMALL		ELEMENT LARGE		MOTOR		CONTACTOR		TRANSFORMER			
											
1802-11001-000 DH1583A DH1583B DH1583C		1802-11001-001 DH1583A DH1583B DH1583C		3900-11002-000 DH1021A DH1021CKA DH1021CKB DH1021CKC DH1521A DH1521B DH1521C DH1523A DH1523B DH1523C DH1543A DH1543B DH1543C DH3043A DH3043B DH3043C		5018-0006-000 DH1543A DH1543B DH1543C DH3043A DH3043B DH3043C		5018-0006-004 DH1021A DH1021CKA DH1021CKB DH1521A DH1521B DH1521C DH1523A DH1523B DH1523C DH1583A DH1583B DH1583C		5814-0003-002 DH1543A DH1543B DH1543C DH3043A DH3043B DH3043C	
1802-11001-002 DH1021A DH1021CKA DH1021CKB DH1021CKC DH1521A DH1521B DH1521C DH1523A DH1523B DH1523C DH1543A DH1543B DH1543C DH3043A DH3043B DH3043C		1802-11001-003 DH1021A DH1021CKA DH1021CKB DH1021CKC DH1521A DH1521B DH1521C DH1523A DH1523B DH1523C DH1543A DH1543B DH1543C DH3043A DH3043B DH3043C		3900-11002-001 DH1543A DH1543B DH1543C DH3043A DH3043B DH3043C		5018-0006-002 DH1021CKC					
FAN BLADE		HI LIMIT		THERMOSTAT		CAPACITOR		GUARD REAR		GUARD FRONT	
											
1210-0098-001 ALL MODELS		410029000 ALL MODELS		5813-2059-000 ALL MODELS		1432-0002-003 ALL MODELS		2504-11004-000 ALL MODELS		2504-11005-000 ALL MODELS	
HANDLE		CART KNOB		THERMOSTAT KNOB		WHEEL		SHAFT CAP		AXEL SHAFT	
											
2710-11001-000 ALL MODELS		3301-11003-000 ALL MODELS		3301-11018-002 ALL MODELS		6406-11001-000 ALL MODELS		1408-11002-000 ALL MODELS		5217-11001-000 ALL MODELS	
CORD		FUSE		FUSE BLOCK		FAN RELAY		FAN DELAY		AUXILIARY SWITCH	
											
1016-10593-000 DH1021CKA DH1021CKB SCS10063 DH1021CKC		2019-7008-077 DH1521A DH1521B DH1521C		480030007 DH1521A DH1521B DH1521C		5018-0007-000 DH1543A DH1543B DH1543C DH3043A DH3043B DH3043C		1414-2039-000 DH3043C		5216-10564-000 DH1521C DH1543A DH1543B DH1543C DH3043A DH3043B DH3043C	
											

CC & DCC		
SPOT LIMIT	THERMOSTAT 1-POLE	THERMOSTAT 2-POLE
		
410027000 ALL MODELS	410112000 ALL MODELS	410113000 ALL MODELS

DB SERIES				
				
DISCRIPTION	PART NUMBERS			
	120V	208V	240V	277V
*ELEMENT (100 WATTS/FT)				
38"	1802-2016-014	1802-2016-006	1802-2016-007	1802-2016-015
50"	1802-2016-016	1802-2016-017	1802-2016-018	1802-2016-019
62"	1802-2016-026	1802-2016-027	1802-2016-028	1802-2016-029
*ELEMENT (188 WATTS/FT)				
38"	1802-2016-012	1802-2016-010	1802-2016-011	1802-2016-013
50"	1802-2016-020	1802-2016-024	1802-2016-025	1802-2016-021
62"	1802-2016-030	1802-2016-034	1802-2016-035	1802-2016-031
				
LINEAR LIMIT		TERMINAL BOX COVER	ELEMENT HANGER CLIP	
38"	410122003	310527001	402020000	
50"	410122004			
62"	410122005			

WRL SERIES (OBSOLETE)

ELEMENT

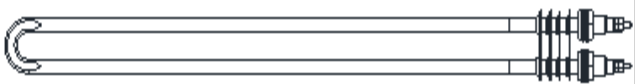

1802-7076-001

L1511B

1802-7076-008

L4521B

HE45240

L4521

1802-7076-003

L2021B

1802-7076-010

L4541B

HE45480

L4541

1802-7076-005

L2041B

1802-7076-011

L4561B

HE20240

L6023

1802-7076-006

L2061B

1802-7076-009

L4571B

HE20480

L6043

1802-7076-004

L2071B

1802-7076-007

L4581B

HE45480

L13543

1802-7076-002

L2081B

RELECTOR

891755004

L1511B

891755002

L4581B

L4541B

L4521B



1.5KW Portable



4.5KW Portable

YRN SERIES (OBSOLETE)

ELEMENT





1802-2115-001 N1011A	1802-2115-013 N2001A	1802-7077-001 N1011B	1802-7077-009 N2001B
1802-2115-004 N1021A	1802-2115-015 N2021A	1802-7077-003 N1021B	1802-7077-010 N2021B
1802-2115-006 N1031A	1802-2115-017 N2031A	1802-7077-002 N1081B	1802-7077-012 N2031B
1802-2115-005 N1071A	1802-2115-016 N2071A	1802-7077-004 N1511B	1802-7077-011 N2071B
1802-2115-008 N1501A	1802-2115-018 N2501A	1802-7077-006 N1521B	1802-7077-013 N2501B
1802-2115-007 N1511A	1802-2115-020 N2521A	1802-7077-008 N1531B	1802-7077-014 N2521B
1802-2115-010 N1521A	1802-2115-022 N2531A	1802-7077-007 N1571B	1802-7077-016 N2531B
1802-2115-012 N1531A	1802-2115-021 N2571A	1802-7077-005 N1581B	1802-7077-015 N2571B
1802-2115-011 N1571A			





FRR & PMRR SERIES (OBSOLETE)

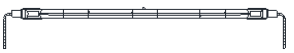

ELEMENT

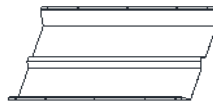
			
1802-0070-509 RR22012A	1802-2113-501 RR41512A	1802-2119-500 RR10512A	1802-2151-001 RR26164
1802-0070-550 RR35724A	1802-2113-516 RR53024A	RR11012A	1802-2151-000 RR26168

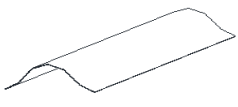
REFLECTOR



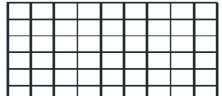

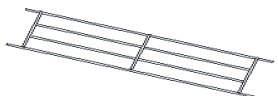
			
5007-2013-000 RR41512A	5007-2020-000 RR22012A	5007-2021-000 RR10512A	5007-2027-000 RR26164
5007-2013-001 RR53024A	5007-2020-001 RR35724A	RR11012A	RR26168

WIRE GUARD

			
2504-2014-000 RR35724A	2504-2015-000 RR22012A	2504-2016-000 RR41512A	2504-2017-000 RR10512A
		2504-2016-001 RR53024A	RR11012A
		2504-2016-002 RR26164	
		RR26168	

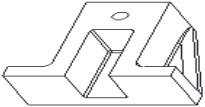
CERAMIC BLOCK

SWITCH





			
1224-0049-000 RR22012A	1224-2006-000 RR10512A	410024000 RR11012A	5216-11009-000 RR22012A
RR26164	RR11012A		RR35724A
RR26168			
RR35724A			

ELEMENT BUSHING

CORD

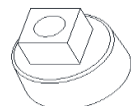
CHAIN 4'

"S" HOOKS

			
1213-0070-000 RR22012A	1420-2016-000 RR10512A	1404-2000-001 RR10512A	2706-2000-000 RR10512A
RR26164	RR41512A	RR11012A	RR11012A
RR26168	1420-2016-008 RR11012A	RR22012A	RR22012A
RR35724A	1420-2016-002 RR22012A	RR35724A	RR35724A
	1420-2031-000 RR35724A	RR41512A	RR41512A
	1420-2016-001 RR53024A	RR53024A	RR53024A

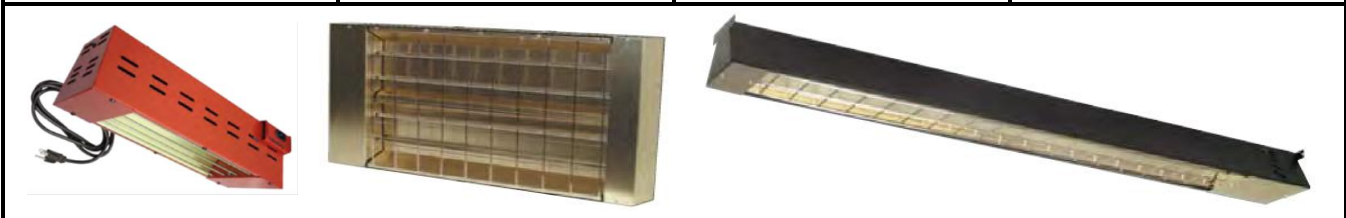

RH SERIES

KEY NUMBER	DESCRIPTION	PART NUMBER		
		RH__26	RH__35	RH__48
1	REFLECTOR: 60/90 SYM	-	-	-
	30 DEGREES SYM	-	-	-
	60/90 ASYM	-	-	-
	30 DEGREES ASYM	-	-	-
2	INSULATOR	-	-	-
3	TERMINAL BLOCK (4 REQ)	1224-0049-000	1224-0049-000	1224-0049-000
4	ELEMENT TERM. BUSH. (4 REQ)	1213-0070-000	1213-0070-000	1213-0070-000
ELEMENTS				
-	RH16-91S-208	2QL16208		
	RH16-91S-240	2QL16240		
	RH16-91S-277	2QL16277		

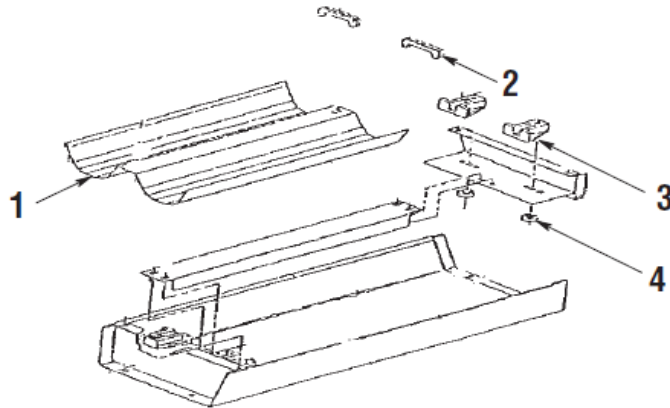

INDUSTRIAL CEILING FANS (FANS ARE PHASED OUT SOME PARTS MAY NOT BE AVAILABLE)

BLADE (SET)

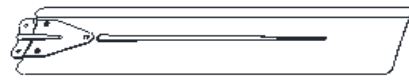

9B3620-1 36201	9B4820-3 48203	9B5600-1 56001	9B6000-1 60001	9B5630-1R 56301RDP
9B4820-1 48201	9B5600-1LC 56001LC	56002	9B6001-1 60011	
48207	56101	56003	9B6011-1 60101	
9B4820-1B 48201B	56111	9B5601-1 56011	60111	
		9B5600-1B 56001B	9B5620-1 56201	

DOWNROD 24"

DOWNROD 8"

MOTOR



9D24BW 36201	9D248BLK 48201B	9D08 36201	9M3620-1-A 36201	9M5600-1LC-A 56001LC	9M5601-1-A 56011
48201	56001B	48201	9M4820-1-A 48201	9M5600-1-A 56001	5611-1U 56101
56001LC	9D248B 56011	56001LC	9M4820-1B-A 48201B	9M5600-1B-A 56001B	56111
56001	60011	56003	9M4820-3-A 48203	9M5600-4-A 56002	9M5630-1R-A 56301RDP
56002	9D12TW 56101	9D088BLK 48201B	9M5600-7-A 48207	9M5600-3-A 56003	9M6000-1-A 60001
56003	56111		6011-1U 60101	9M5600-7-A 56007	9M6001-1-A 60011
56007	60101		60111		9M5620-1-A 56201
56301RDP	60111				
48203					
48207					
60001					
56201					

RUBBER ROLLER

J HOOK KIT

BLADE SCREWS (6 REQ)

BLADE PADS (3 REQ)

REVERSIBLE TOGGLE

REVERSING SW. PLATE

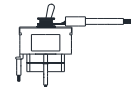
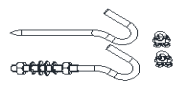
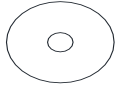

9F2900-04A ALL MODELS	9F2900-01 ALL MODELS	9F2900-20A ALL MODELS	9F2900-19A ALL MODELS	9F2GX54-73 56301RDP	9FP005 56301RDP
---------------------------------	--------------------------------	---------------------------------	---------------------------------	-------------------------------	---------------------------

CANOPY UPPER

CANOPY LOWER



9F2900-07A 36201	9F2900-07AB 48201B	9F2900-08A 36201		9F2900-08AB 48201B
48201	56001B	48201	60001	56001B
56001LC	9FP029 56011	56001LC	60111	9FP030 56011
56001	60011	56001	56301RDP	56011
56002	3100039A 56101	56002	48203	60011
56003	56111	56003	48207	
56007	60101	56007	56101	
56301RDP	60111		56111	
48203				
48207				
60001				
56201				

3-SPEED PULL CHAIN SW.

PULL CHAIN STRING

OUTDOOR KIT

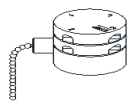

PICTURE NOT AVAILABLE

9F2900-26 48203	3378 48203	99992 56101
56003	56003	60101

