



Intertek
3073615

AIRREX[®]

AIR CONDITIONER

USER'S MANUAL

MODEL : HWC-19



- ▶ Thank you for purchasing the unit. Before operation please read this user's manual carefully.
- ▶ Keep this manual on hand for reference.
- ▶ This unit is specified for use on the rated voltage power supply. For use outside the local electricity supply should be checked by a qualified electrician.
- ▶ It is essential that you read 'SAFETY INSTRUCTIONS' carefully before use and follow them at all times.
- ▶ The warranty form is on the last page. Please complete it now and keep it in a safe place.
- ▶ We have a policy of continual improving on our products. The contents (features and specifications) in this manual are therefore subject to change without notice.

TABLE OF CONTENTS

■ SAFETY INSTRUCTIONS	3~4
■ PRECAUTIONS FOR USE	4
■ EXTERIOR DESCRIPTION	5
■ SPECIFICATIONS	6
■ CONTROL PANEL FUNCTIONS	7
■ MODE CHANGING METHOD	8
■ HOW TO SET THE 'OFF' TIMER	9
■ TEMPERATURE CONTROL OPERATION	10
■ SELECTION	11
■ 'ERROR' and WARNING INDICATORS	12
■ ECONOMIC MODE	13
■ TROUBLE SHOOTING	14
■ CLEANING AND MAINTENANCE	15
■ HOW TO INSTALL & PRECAUTIONS	16~17
■ ACCESSORIES	18
■ WARRANTY	20

The following instructions are to ensure user's safety and to prevent any physical injury or material damage. Please read carefully and follow all instructions. There are two sections to these instructions: WARNING and CAUTION.

SAFETY INSTRUCTIONS



These are contents for keeping the safety and preventing the property damage. Please read and use correctly.

- Precautions on this page are for the safe and correct use of the unit and for the preventing a danger and damage of the operator or others. With regard to the contents, these are classified into <WARNING> and <CAUTION>. These are important for the safety, so please observe them without fail.















 **WARNING** This is the content that when a faulty handling is done, a person's death or heavy injury is expected.

 **CAUTION** This is the content that when a faulty handling is done, a person's injury or property damage is expected.

Meaning of the figural symbol

-  indicates a prohibition.  indicates a matter that must be done without fail.

 **WARNING** As for a damage that occurs during non-keeping the following cautions, the manufacturing company cannot be responsible for the compensation.











- | | |
|---|---|
|  Use an outlet for exclusive use of alternative current 115V.
(A fire or electric shock may be caused.) |  After wiping out dusts from the power plug, insert it correctly into outlet
(Due to electric shock or short, a smoking or fire may happen.) |
|  Do not use a damaged electric cord, plug or loosened outlet.
(An electric shock, short or fire may be caused.) |  Use a rated capacity fuse.
(A trouble or fire may be caused.) |
|  Do not pull out the cord or touch the power plug with a wet hand.
(An electric shock, fire may be caused.) |  Do not forcibly bend the cable or press by a heavy thing for not being damaged.
(Electric shock or fire may be caused.) |
|  Do not connect or extend a power cord in the middle of it.
(An electric shock, fire may be caused.) |  Insert a cord into the outlet with earthed terminal.
(In case of common outlet, set a separate earth terminal without fail.) |
|  When cleaning, pull out the plug without fail.
(An electric shock may be caused.) |  When water supply is stopped or leaked, do not operate the unit. |
|  Do not connect to other power outlet or home appliance by using extension cord. |  Do not randomly disassemble or remodel the product.
(A trouble, electric shock, or fire may be caused.) |
|  Do not insert a finger or stick into blowing hole. Hurt may be caused, so give a warning to children. |  In case of a strange sound or smell in the air conditioner, stop the operation and cut off the power, and contact the Service Center.
(A continuous operation in abnormal condition, a trouble, electric shock, fire may be caused.) |

♣ After reading carefully, keep it where any user may see it anytime.

SAFETY INSTRUCTIONS

CAUTION

For the damage occurred due to non-keeping of following matters, the manufacturer is not responsible for the compensation.

-  Do not install the product on the uneven or slant place.
-  In case of thunder, lightning or no-operation for a long time, pull the power plug out of the outlet. (Electric shock, leakage or fire may be caused.)
-  For safekeeping, avoid hot, humid place, and keep it in dry indoor place. (Rusting or trouble may be caused.)
-  When inserting/ pulling out the power plug, grip the plug. (A fire may be caused by electric shock or short-circuit.)
-  In case of power cord's damage, contact A/S Center for changing it. (Electric shock or fire may be caused.)
-  Do not spray water on to the cooler nor use solvents such as benzene, thinner or alcohol for cleaning. (There is a risk of electric shock and / or short circuit)
-  Do not step on the product or put a thing on it. (Trouble or electric shock may be caused.)
-  Excessive cold wind may be harmful to health.
-  During operation, do not pull the water supply hose or the drain hose. Water leakage or fire damage may be caused.
-  Do correctly the grounding device work without fail. However, do not connect to the gas pipe, water pipe or telephone line. (If the grounding device is not set, a trouble or electric shock may be caused.)
-  For preventing water leakage, close the water supply valve.

PRECAUTIONS FOR USE

1. Rated voltage of this product is 115Vac 60Hz 1Ph. Connect to the rated power source and the earthed outlet.
2. Make sure of the safety of the place to be used.
3. Do not touch the power cord with a wet hand.
4. When moving this product, do not lean more than 30° or topple it. (When operating, keep it horizontal, or in unavoidable situation, keep it less than 2°.)
5. Do the exclusive power circuit for the air conditioner.
6. Do not pull the power cord. (If the power cord is damaged, a fire or electric shock may be caused.)
7. Use the standardized fuse without fail.
8. Operate efficiently the unit under the shadow, and avoid operation in the temperature higher than 113°F.
9. Keep space more than 20 inch around the air-intake so that a smooth in-taking of air can be done.
10. As dust in the filter or the heat-exchanger deteriorat the cooling, do clean the filter of the heat-exchanger regularly.
11. When using the product, use it indoor place free from direct sunlight.
12. Do not use this product as a means of moving other heavy goods or as a carrier of man.
13. Do not insert any foreign substance (can, bottle of drink) into cold air discharge hole. It may damage the product.
14. Do not put an obstacle in front of the air-intake hole. (Trouble may be caused.)
15. The optimum distance between the worker and the discharge duct is less than 80 inch.
16. When use, fix the locking device of front wheel at ON. (For release, press OFF.)
17. Do not use it, when water supply is stopped. (When water stoppage, re-operating is possible up to 2 times, and in case of water stoppage or shortage, the error E1 is shown and the operation will be stopped.)
18. If the water supply is low, the product cannot be normally operated, and main parts may be damaged.
19. Discharged water is in state that removed indoor heat is added to the pure tap water, thus the waste heat can be re-used for other purpose. (But, it cannot be used as drinking water.)

EXTERIOR DESCRIPTION

FRONT VIEW

♣ For the efficient improvement of this product, the specification may be changed without prior notice.

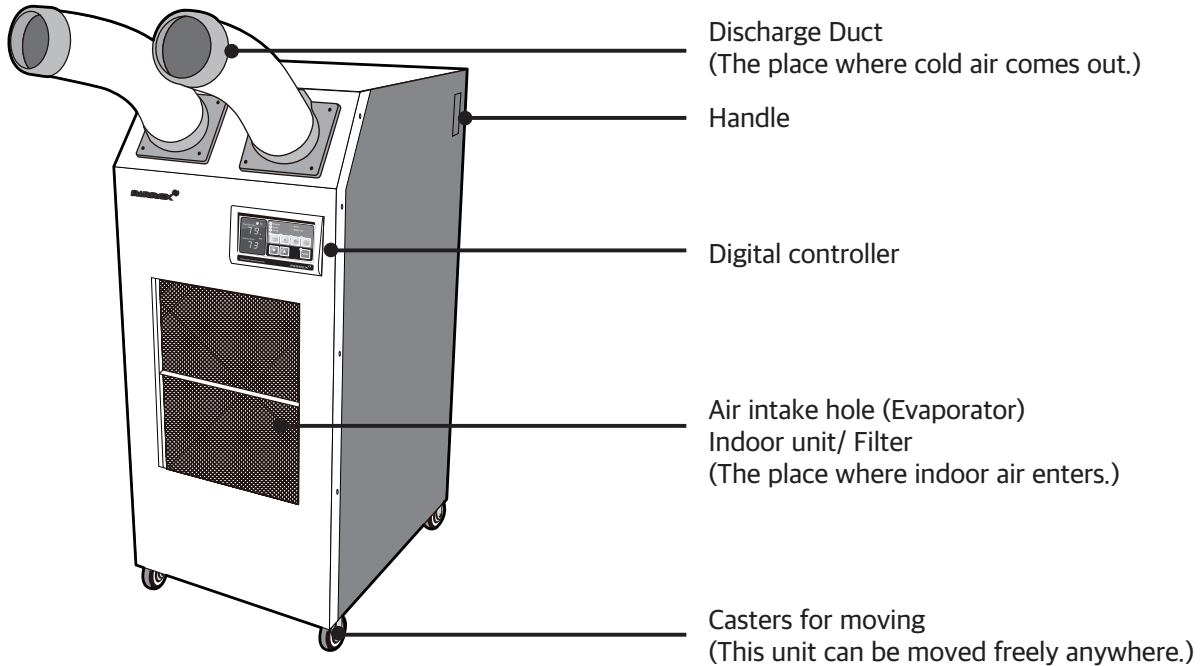

BACK & SIDE VIEW

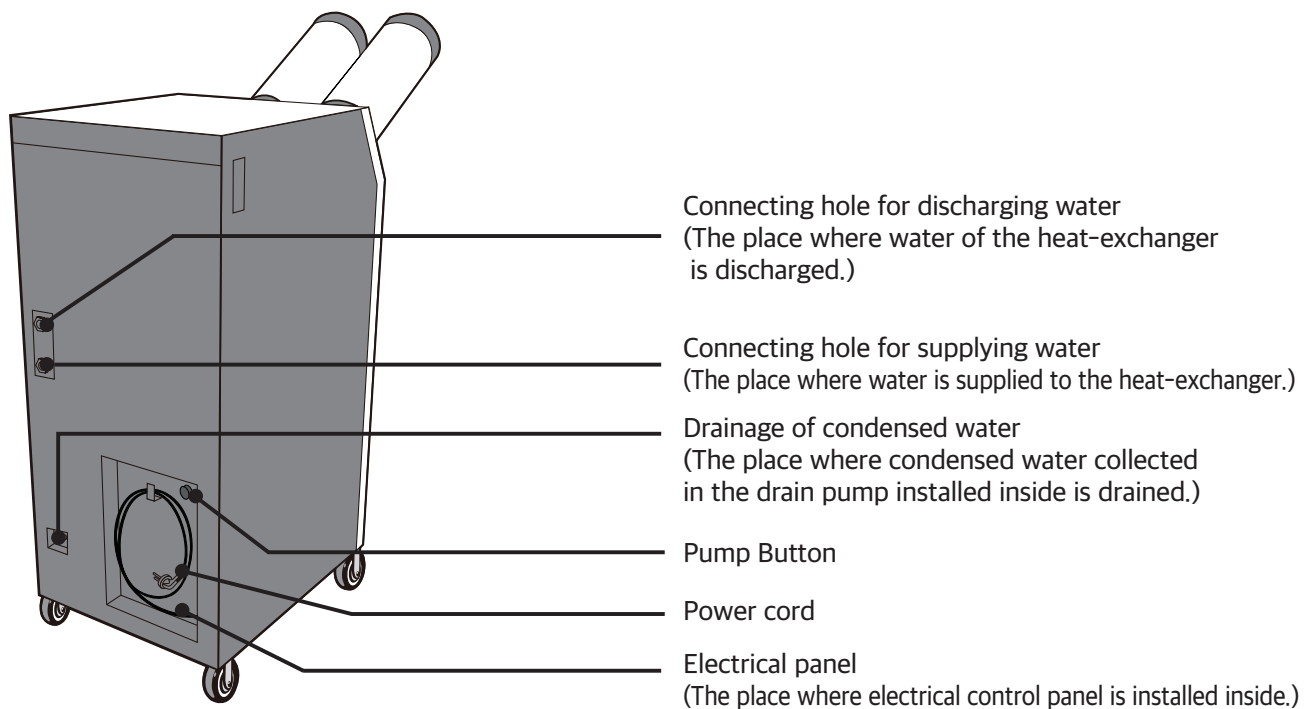

SPECIFICATIONS

MODEL		HWC-19	
Cooling Capacity	Btu/h (W)	18,200 (5,300)	
Power supply	-	115Vac 60Hz 1Ph	
Power Consumption	kW	1.5	
Current Consumption	A	12.6	
Moisture Removal	gal/day	MAX	13.3
		AHAM	8.9
Refrigerant	lb	R-410A / 1.32	
Dimensions (WxDxH)	inch	17.5 x 22.5 x 43	
Weight	lb	163	
Operating Range		65 ° F DB 60%RH ~ 113 ° F DB 40%RH	
Power cord		LCDI 5-15	

※When operating at less than 72°F, the A.F. fuction can be activated occasionally.(Cooling mode)

CONTROL PANEL FUNCTIONS

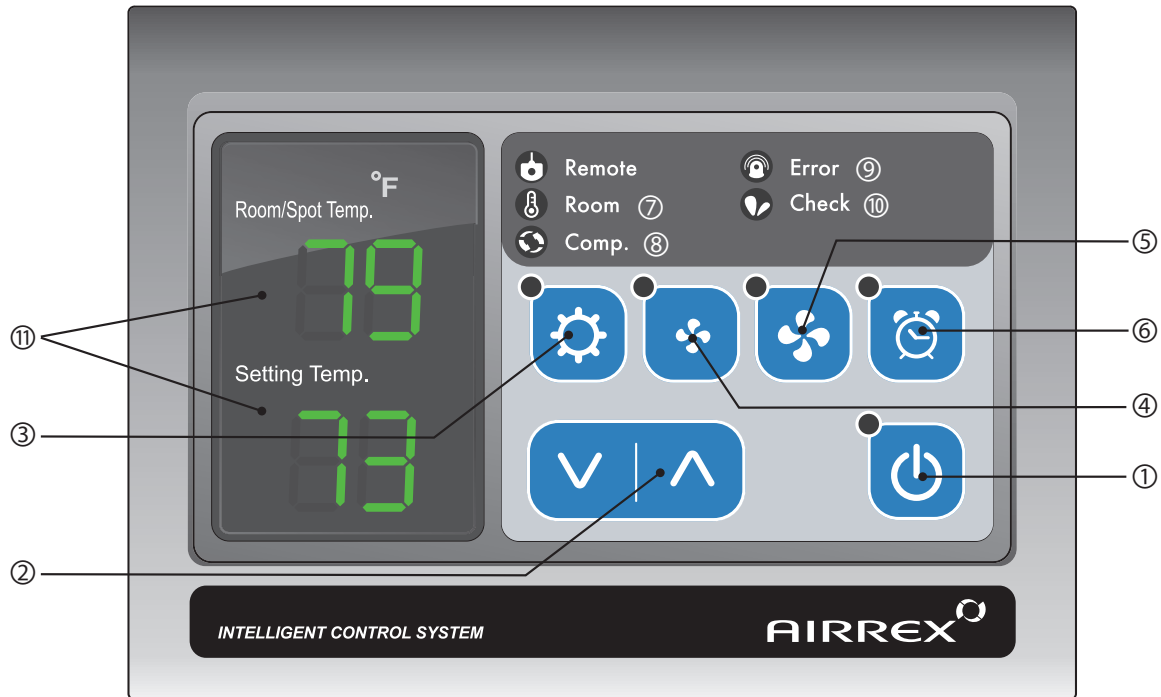

- ① Power : Use to power on / off.
- ② ∨ ^ Button : Raises or lowers the setting temperature or sleep (off) time.
- ③ Mode : Use to select Cooling / Fan / Dehumidifier mode.
- ④ Low Speed : Controls fan low speed.
- ⑤ High Speed : Controls fan high speed.
- ⑥ Off Timer : To set the length of time, once turned on, that you wish the cooler to run for.
You can set 0~24 hours. Time intervals are 30 mins. up to 10 hours and then 1 hour between 10 and 24 hours.
- ⑦ Room : If the LED is on, the displayed temperature is for room temp.
- ⑧ Comp. : When the compressor is operating, the LED is on.
- ⑨ Error : Error signal.
- ⑩ Check : If water full or Aligh Drain Tank is checking. The LED is on.
- ⑪ Display : Display Room temperature, and also the setting temp and sleep time if they had been set.

MODE CHANGING METHOD

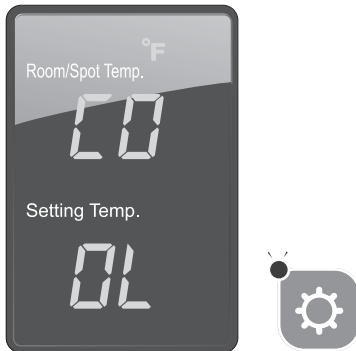

※ COOLING MODE

If you press 'Mode' button, 'COOL' is displayed, then LED is on.

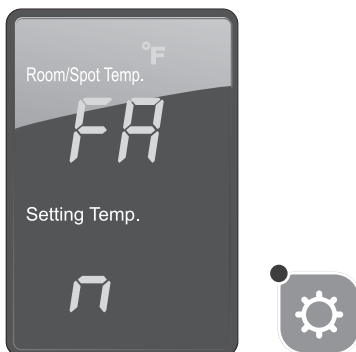

※ FAN MODE

When the cooling is operating. If you press the 'Mode' button, 'FAN' is displayed, then LED is off.

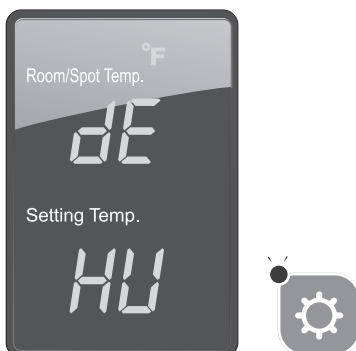

※ DEHUMIDIFICATION MODE

When the fan is operating, If you press the 'Mode' button, 'DEHU' is displayed, then LED is on.

HOW TO SET THE 'OFF' TIMER

This function enables you to set the length of time you want the unit to operate. You can set the time period from 30min. to 24 hours in 30min. and 1 hour increments.

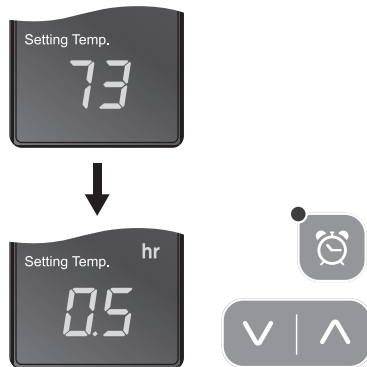

1. When unit is operating, press the 'Off Timer' button and set the length of time you want by pressing \wedge or \vee . Each time you press the button you will increase the 'time to off' period by 30mins. up to 10 hours, and 1 hour up to 24 hours. The display will show 5 for 30min and 1 for an hour. One and a half hours will show 1.5.



2. When you have finished setting the time period, the 'Off Timer' lamp will be on which indicates the unit is in sleep (Off Timer) mode.

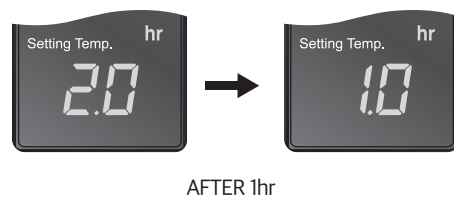

3. If you press the 'Off Timer' button during its operation, the remaining time will be shown.

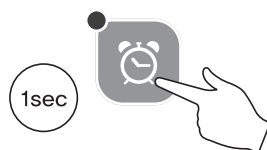

4. To CANCEL timing, press and hold 'Off Timer' button for 1 second. It will then switch the timer off automatically.

TEMPERATURE CONTROL OPERATION

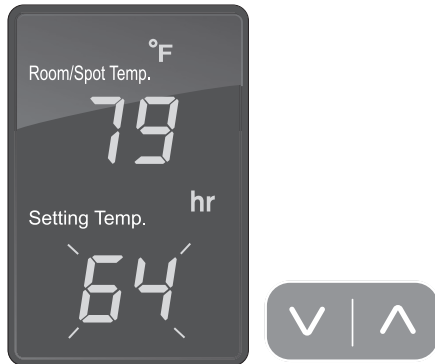

- When you turn ON, the setting temperature is displayed.
- You can change setting temperature.
- The display showing the set temperature will blink 3 times.

Display Room Temperature range & Setting range.

COOLING MODE

Mode	Display range	Setting range
Room	32°F ~ 99°F	64°F ~ 86°F
Spot		34°F ~ 86°F

Cooling operates when Room temperature is more than set temperature.

Cooling stops when Room temperature is less than set temperature.

SELECTION

SPOT or ROOM MODE



To change the temperature of the entire room, select Spot or Room mode. For 'targeted' cooling of machinery servers or people etc select 'spot mode'. Applicable only when cooling mode.

- If you want to display room temperature, when unit is operated, push 'mode' and 'v' button simultaneously for 3 seconds.
- Light be on the 'Room LED' when room mode set.

LOCK or UNLOCK



- If you press 'v' for 5 seconds when the unit is turned off you can control 'LOCK, UNLOCK' mode.
- When You set 'LOCK' there will be '.' below the number in the screen.

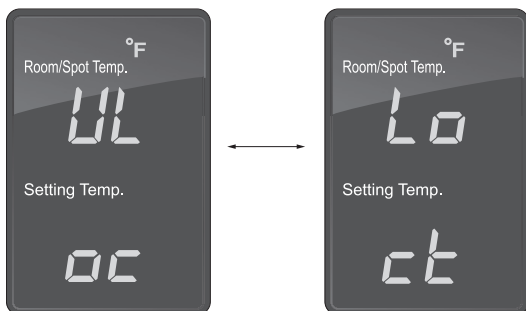

- You can set 'UNLOCK' or 'LOCK' after pressing '^' button.

°F or °C

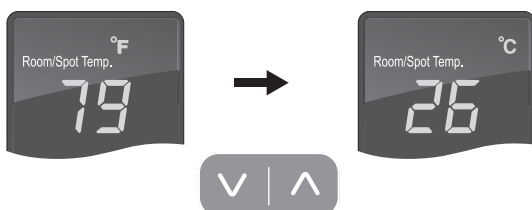

- If you want to change temperature unit °F ↔ °C, when the unit is stopped, push 'v' and '^' button simultaneously for 3 seconds.

'ERROR' and WARNING INDICATORS

Error Code	Problem	Cause	Corrective Action
	High pressure	Blocked air filter Blocked / kinked exhaust duct Ambient temperature is too high	Ensure exhaust duct is not blocked / kinked Do not use the air conditioner if ambient temperature is higher than 113°F
	Low pressure	Verify Electrical Refrigerant may be low	Clean Filters and Coils Verify Power (Voltage/Amps) Check Filters Evaporator/Condenser Check Evaporator/Condenser Coils Check refrigerant level and/or refrigerant leak.
	Sensor	Temperature sensor has an electric short.	Exchange temperature sensor
	Water full	Condensate tank is full	Check the water pump or water hose bended
	Anti-Freezing alarm	Evaporator is below 25 °F (-4 °C) due to being used in a low ambient temperature area.	Do not use the unit in an ambient temperature less than 72°F (22°C). Check refrigerant level.

ECONOMIC MODE

Model	Cond. Fan		Evap. Fan		economic mode button (3 sec. continuous)	Etc.
	Economy	Normal	Economy	Normal		
HSC-12L	-	-	Stop after 30 sec.	Run	airflow	Fan integral type
HSC(O)-14/18	Stop	Run	Stop after 30 sec.	Run	airflow (High)	
HSC(O)-24A	Stop	Run	Stop after 30 sec.	Run	airflow (High)	
HWC-19	Stop	Run	Stop after 30 sec.	Run	airflow (High)	
HSC(O)-36B	Stop after 1 min.	Stop after 1 min.	Stop after 1 min.	Run	▲ (UP)	
HSC(O)-60	Stop after 1 min.	Stop after 1 min.	Stop after 1 min.	Run	▲ (UP)	
HSC-70	Stop after 1 min.	Stop after 1 min.	Stop after 1 min.	Run	▲ (UP)	
AHSC-12	Stop	Run	Stop after 30 sec.	Run	airflow	
AHSC-14	Stop	Run	Stop after 30 sec.	Run	airflow	
AHSC-18	Stop	Run	Stop after 30 sec.	Run	airflow	
AHSC-42	Stop	Run	Stop after 30 sec.	Run	▲ (UP)	
AHSC-60	Stop	Run	Stop after 30 sec.	Run	▲ (UP)	
AHSC-140	Stop after 1 min.	Stop after 1 min.	Stop after 1 min.	Run	▲ (UP)	

TROUBLE SHOOTING

Symptom	Check Points	Measures to be Taken
The operation is not done.	<p>Is the power plug pulled out? Is the operation stopped?</p> <p>Is the fuse cut? Is the circuit breaker fallen?</p> <p>Is the surrounding temperature too high?</p> <p>Is the voltage too low?</p>	<p>Insert the plug. Press ON/ OFF switch, and confirm the lamp condition. Change the fuse of electric panel. After confirming the load capacity, raise the circuit breaker of the distribution panel. Use it at the place of 113°F and lower. (Higher than 113°F) Request an electricity construction company for the available rated voltage</p>
The cooling is not well done.	<p>Is the filter clogged with dust? Although the filter is clean, is the heat-exchanger clogged with much dust? Is there any obstacle in the in-taking part? Is the set-temperature correctly set?</p> <p>Is the water supply cut? Right after the operation stops, is the unit started to operate instantly?</p>	<p>Clean the filter (Washing with water is OK.) Clean the heat-exchanger.</p> <p>Remove the obstacle. (Farther than 8inch.) For cooling, adjust the set temperature lower than the ambient temperature. Confirm the water supply valve is opened. Confirm that after 3 minutes, the compressor is normally operated and the cold air is being discharged.</p>
When white vapor is generated during operation.	<p>Is the unit being used where humidity is high?</p>	<p>If the humidity is high, much air is discharged, and white vapor may be emitted.</p>
When dew is formed at the discharging hole.	<p>Is the room temperature too high?</p>	<p>It is a phenomenon that the moisture in the air is changed into dew, and this is not abnormal.</p>

CLEANING AND MAINTENANCE

Cleaning the Air Filters and Maintenance

Cleaning of filter : Detach the filter from the A/C, and clean it with compressed air or water.

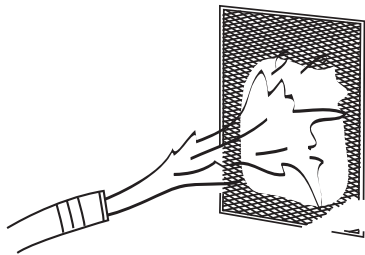

Cleaning of heat-exchanger : Clean dust attached to the heat-exchanger with compressed air or a vacuum cleaner.

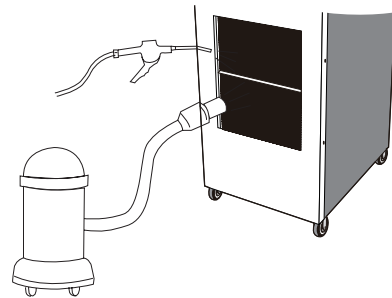

1. After cleaning, dry well the inside by blowing operation for 3~4 hours.

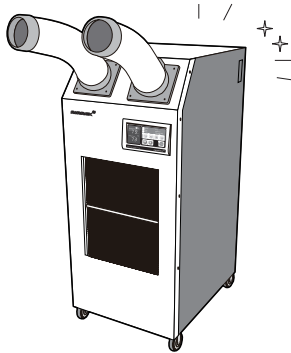

2. After stopping operation and pulling out the power cord, do wind well and fix the cord.

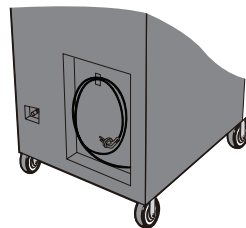

3. Note that moisture and dust not to enter into the unit.

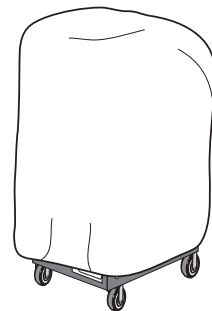

※ When it is not used, close the valve of the water supplying line, and discharge the water in the line, and keep it after being dried.

HOW TO INSTALL & PRECAUTIONS

Selection of the Installation Place

- As the air conditioner should be connected to the tap water tube, its installation near the hydrant is good.
- Install it on the even and stable place.

How to Connect Pipes

1. Connect the nipple at the water in-taking hole and the water discharge hole of the backside of the air conditioner. At this time, wind the Teflon tape at the thread part and fasten it the main body.

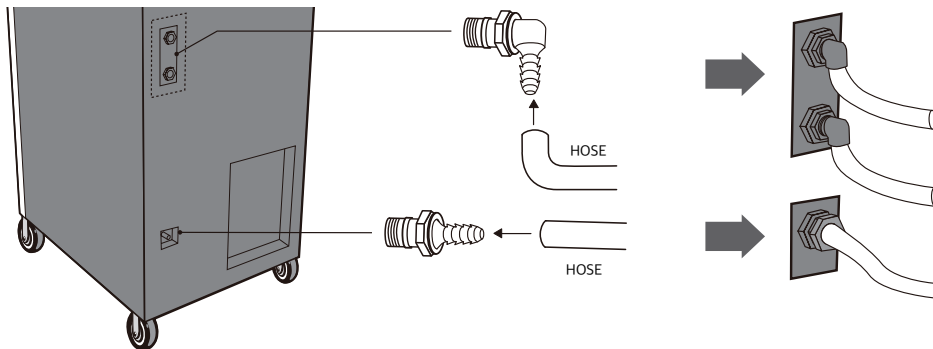

2. Unfasten the nut and ring at the nipple and connect it to the hose, and insert the hose into the nipple and fasten it by using the nut. (When connecting the hose, make the cut surface of the hose even.)
3. Connect the water in-taking hole to the tap water tube (or a pressuring pump), and the water discharge hole to the drain hole. (Pay attention for not changing the water in-taking hole with the discharging hole.)
4. Connect the discharging hose with the condensed water discharge hole and to the draining hole.

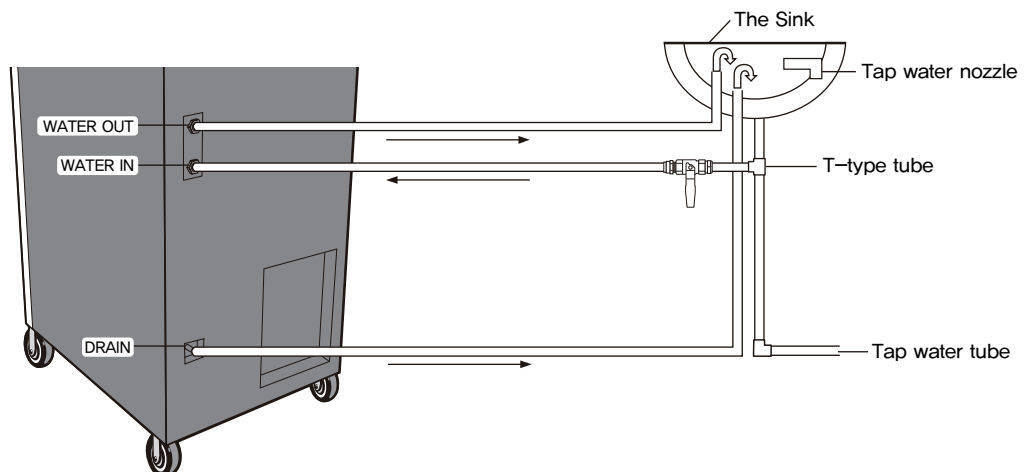

5. Once the pipe connection is finished, open the valve of water supply line so that water is supplied. At this time, as water is discharged only when the air-conditioner is operated, check whether water is discharged from the drain hole.

HOW TO INSTALL & PRECAUTIONS

Check Points after Installation

- After confirming the state of pipe connection, check whether a leakage is at the connection part.
- Confirm whether the connection of the drain hose is good.
- Confirm whether the earth line is good.

Precautions for Installation

1. Do the earth line work in good state without fail. (Do not connect it to the gas pipe, water pipe or telephone line.)
2. Connect the power source of the air-conditioner to the exclusive cable and the correct voltage.
3. Do not connect the power line in the middle or extend it. (Electric shock or fire may be caused.)
4. Do not install the unit at the place of an inflammable gas leakage or heat of fire.
(If the leaked gas is accumulated around the air-conditioner, a blast or fire may be caused.)
5. Note that if the drain hose is unstably set, water cannot be drained.
6. The standard pressure of water in-taking of this product is 28~71psig. When the pressure exceeds the standard, install a decompression device, and in case of lower pressure than the standard, install a separate device (Pressure pump, etc.).
7. When installation, the standard part supplied with the air-conditioner should be installed.
8. For piping for water in-taking or discharging, a hose may be used for a short distance (3~33 ft), and for a long distance more than 33 ft, a proper material (Matchable, X-L pipe) should be installed in principle.
9. Connect the pipe correctly not the in-take direction to be changed with the discharging one.
10. The exposed in-taking pipe should be thermally insulated. (Condensation prevention of in-taking water and the prevention of freeze break in winter season.)

ACCESSORIES

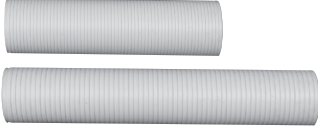
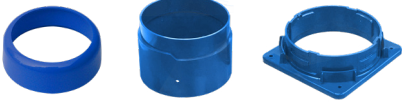
ITEM					DRAWING
AIR OUTLET	DUCT	Diam. 5inch	1 ft	○	
			10 ft	option	
	DUCT COVER			○	
	DUCT LOWER			○	
	DUCT BASE			○	
	ALUMINIUM FILTER CASSETTE				○

MANUAL PUMPING

- When you keep the unit, it is necessary to empty condensate water in tank. So press pump button to empty water in tank.



WARRANTY

(Applicable to first retail purchaser only)

AIRREX unit gives the more reliable performance, comfort and durability the more they are used. They are built under a strict quality assurance regime which includes inspection both during and after production and exhaustive reliability testing.

In the unlikely event you have any problems, please contact your dealer or distributor. If the problem is as a result of a production fault or failure, repairs will be undertaken free of charge during the period of warranty subject to the following warranty conditions:

1. If the problem has been caused by customer error or misuse, abuse or damage, then all repairs will be charged for.
2. This warranty applies to your country.
3. Proof and date of purchase must be supplied.
4. Please complete the details below and keep this warranty in a safe place.
5. All transportation charges back to the dealer are at customer's cost. Keep all original packaging to facilitate return. Return to customer will be at dealer's cost (if genuine warranty claim).

DESCRIPTION	AIRREX AIR CONDITIONER		
MODEL	HWC-19		
DATE OF PURCHASE		PRODUCT SERIAL NO.	

WARRANTY PERIOD	() Months	
DISTRIBUTOR	Name of Company	
	Telephone No.	

CUSTOMER DETAILS	Name :	
	Address :	
	Telephone :	

Manufactured by :
HEPHZIBAH CO.,LTD.
(Juan-dong) 86, Gilpa-ro
71beon-gil, Michuhol-gu,
Incheon, Korea
TEL : +82-32-509-5834
FAX : +82-32-502-5519
E-mail : airrex@hdtek.com
Website : www.airrex.biz

Distributed by :
Airrex USA
1191 Jewell Dr Ste 101 Waco, TX 76712

TEL : 888-535-8841
FAX : 469-574-7924
E-mail : sales@airrexusa.com
Website : www.airrexusa.com