



# Owner's Manual

Airgle® Room Air Purifier (Model: AG600)

Airgle® Clean Room Air Purifier (Model: AG900)



## TABLE OF CONTENTS

<b>Table of Contents</b> .....	<b>2</b>
<b>Important Safety Precautions</b> .....	<b>3</b>
<b>AG600/900 Air Purifier Systems</b> .....	<b>4</b>
<b>Unpacking and Assembly</b> .....	<b>4</b>
<b>Using the Air Purifier</b> .....	<b>6</b>
Control Knob Settings.....	6
Operation Display .....	7
Advanced Functions .....	8
Using the Handheld Remote .....	10
<b>Airgle® Mobile Application</b> .....	<b>11</b>
Installing the App .....	11
Get Started with the App .....	12
Adding an Airgle Device (AP Mode) .....	14
Control a Single Airgle® Device .....	16
Controlling Multiple Airgle Devices.....	18
Use the Automation Features .....	20
<b>Limited Warranty</b> .....	<b>24</b>
Commercial Use .....	24
What is Not Covered by this Warranty .....	24
<b>Service</b> .....	<b>25</b>
<b>Specifications</b> .....	<b>26</b>

## IMPORTANT SAFETY PRECAUTIONS

When using this or any electrical appliance basic safety precautions should always be followed especially when children are present. These precautions include but are not limited to the following:

- The rated voltage specified on the data plate at the bottom of the device must match the local AC outlet voltage. If the rated voltage specified on the data plate on the Airgle® Air Purifier is 100-120V, it may only be plugged into a 100-120V AC outlet and if the rated voltage specified on the data plate is 220-240V, into a 220-240V AC outlet.
- Always turn off and unplug the Airgle® Air Purifier when not in use.
- Do not use the Airgle® Air Purifier outdoors.
- Do not expose to water or rain to reduce the risk of electric shock.
- Do not immerse the Airgle® Air Purifier in water or splash water on it.
- Do not operate the Airgle® Air Purifier near an open flame.
- Do not obstruct the air inlet or air outlet of the Airgle® Air Purifier.
- Do not let liquids or objects enter the air inlet or air outlet.
- Do not plug in or unplug the machine when your hands are wet.
- Do not unplug by pulling on the power cord, please be sure to grasp and pull the plug rather than pulling on the power cord itself.
- Do not run the cord under carpeting. Do not cover the cord with throw rugs, runners, or similar coverings.
- Do not route the cord under furniture or appliances. Arrange the cord away from traffic areas and where it will not be tripped over.
- Do not use if the supplied power cord is damaged. Damaged cords must be replaced by the manufacturer, its service agent or similarly qualified persons in order to avoid a hazard.
- Disconnect the power supply from your Airgle® Air Purifier by unplugging the power cable before replacing filters, cleaning, moving or doing maintenance.
- Do not attempt to remove any part of the device except parts designated in this manual as being replaceable, such as filters.
- Do not use attachments or filters not recommended by Airgle.
- Do not attempt to repair the Airgle® Air Purifier. If your device is no longer working, contact Airgle for information on where it may be sent for repair by an authorized service facility.
- This product employs an overload protection (fuse). A blown fuse indicates an overload or short-circuit has occurred. If the fuse blows, unplug the product from the outlet. Replace the fuse as per the user servicing instructions (follow product marking for proper fuse rating) and check the product. If the replacement fuse blows, a short circuit may be present, and the product should be discarded or returned to an authorized service facility for examination and/or repair.
- This appliance should not be used by children or persons with reduced physical, sensory or mental capabilities, or lack of experience and knowledge without supervision or instruction concerning use of the appliance and an understanding of the hazards involved.
- When using in a child's room, place where the child cannot reach the device. Children should be supervised to ensure that they do not play with the device. Children should not clean or perform user maintenance without supervision.
- To reduce the risk of fire or electric shock, do not use this device with any solid-state speed control device.
- Save these instructions for future reference.
- Skin or eye damage may result from directly viewing the light produced by the lamp in this apparatus. Always disconnect power before relamping or servicing. Replace lamp with part number AF600T or AF900T, manufactured by Airgle.
- This product complies with the maximum allowable concentration of 0.050 parts per million by volume (ppmv) in a 24-h period. The Health Canada Guideline 2010 recommends that the maximum exposure limit, based on an averaging time of 8 hours, is 0.020 ppmv or less when tested in a sealed, controlled room approximately 30 m<sup>3</sup>.

## AG600/900 AIR PURIFIER SYSTEMS

### Medical Grade Air Filtration Technology for Microbes | Chemicals | Particles in Critical Areas

The Airgle AG600/900 air purifiers are specifically engineered for airborne infection control. Those who suffer from severe allergies, asthma and critical respiratory problems will experience acute relief after use. They feature a cHEPA filter with an efficiency of over 99.999%, premium deep carbon blend, and our next generation Titanium Pro® module.

## UNPACKING AND ASSEMBLY

1. Remove the Airgle® Air Purifier System from the packaging.
2. Do not throw the original box and packaging away. Keep it in case you need to transport the unit again sometime in the future.
3. Check the components received against your packing slip to make sure you have all the parts.
4. Check the unit and all the components for damage. If the unit or any of the components show damage from shipping, contact your local dealer.
5. For your future convenience, record the model information here. Model information can be found on the name plate located on the bottom of your unit.

Model Number:	Purchase Date:	QR Code:

### AG600 INCLUDED AND PREINSTALLED COMPONENTS:

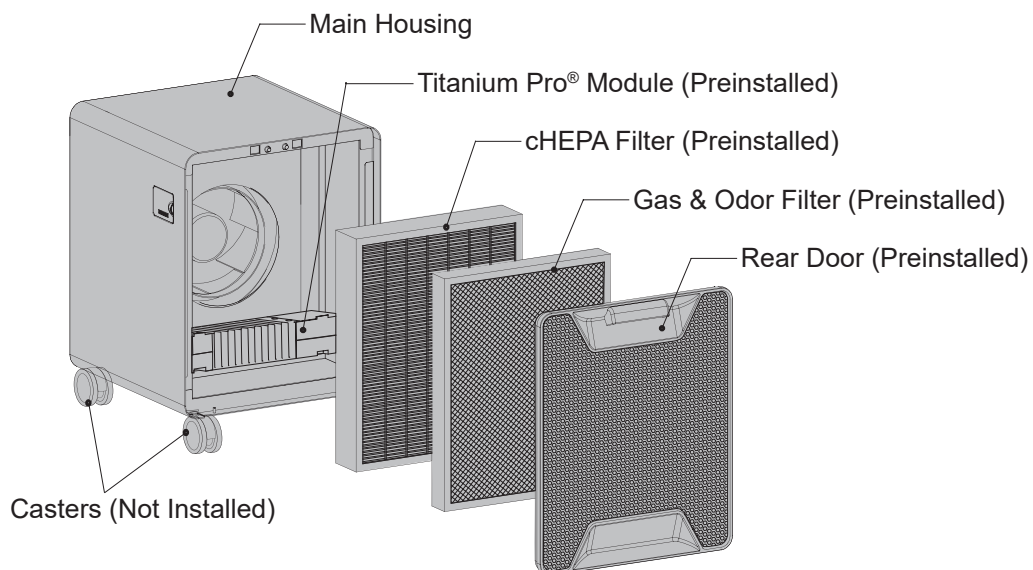

AG900 INCLUDED AND PREINSTALLED COMPONENTS:

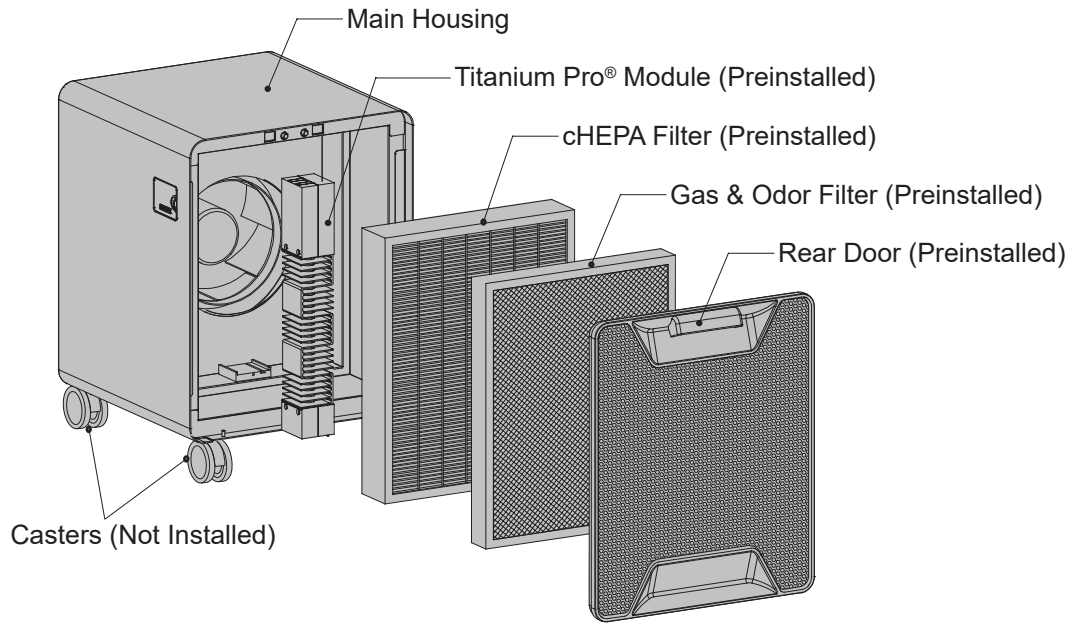

INSTALLING THE INCLUDED CASTERS

- 1) Flip the machine over onto a blanket or box to prevent the surface from getting scratched. Carefully insert the caster stem by pushing it straight down into receptor tube.
- 2) Press on the caster until it is completely seated and aligns with the bottom of the unit.
- 3) Insert the remaining casters in the same way. Ensure each caster is securely fitted before placing the machine in its upright position onto the casters.

\*Flip the machine back over. Always make sure to place the machine on a flat floor.

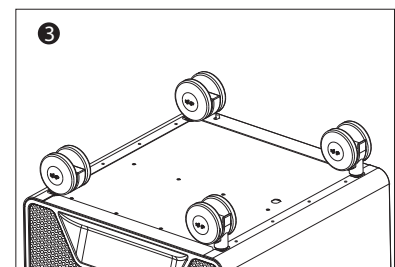
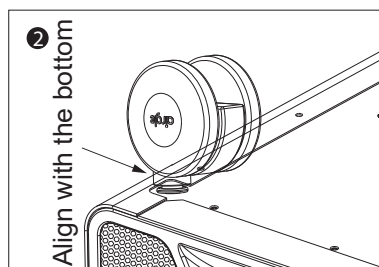
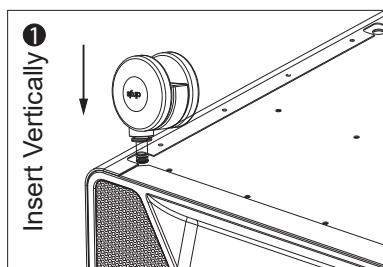

## USING THE AIR PURIFIER

The Airgle® system is equipped with a state-of-the-art control panel. This advanced control panel allows you to assess the unit's status with one quick glance.

### CONTROL KNOB SETTINGS

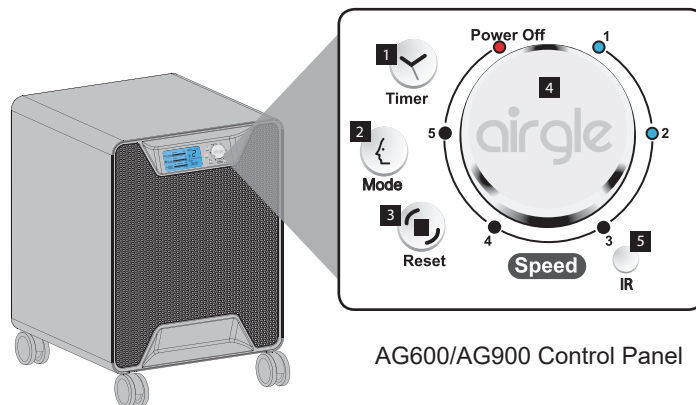

1. **Timer:** Press this button to set the timer for up to 12 hours of continuous operation. The time shows on the bottom right of the LCD display on the left-hand side of the panel.

Each press of the timer button is 1 hour of timed operation. For example.

- Press Timer button once and the LCD displays 01:00 indicating that the purifier will run for 1 hour.
- Press Timer button twice and the LCD displays 02:00 indicating that the purifier will run for 2 hours.

And so on up to 12 hours

2. **Mode:**

- **Auto Mode:** Press the button once to activate the Auto speed function to allow for automatically setting the optimum speed needed for air purification of the room. During auto operation the Air Quality meter will change to the appropriate level of quality. This mode uses the sensor on the side of the unit to determine the optimum speed based on the amount of particles in the room.
- **Sleep Mode:** Press the button twice in succession and the unit will enter Sleep mode. LCD backlight will turn off and change the fan speed to "1".

In Sleep mode, the LCD Panel and UV Lamp can be turned on/off by doing the following:

- To set the UV lamp On or Off press the Mode button and hold down for 5 seconds or more.
- To turn the LCD backlight On or Off press the Mode button again to turn the LCD backlight on.

3. **Reset:** Press this button after replacing any of the filters or the Titanium Pro®. This will reset any blinking lights and set the filter life to full. Note: This function is only activated when any of the filters require changing.

4. Power/Speed: When the air purifier is turned off, the “Power Off” indicator will display as red, and the fan speed indicator will be off. To turn the system on, rotate the Power/Speed knob counterclockwise or clockwise to select a speed from 1 to 5. The default speed for starts from “1”. The light indicator for the selected speed will display as white and the speed you selected will display on the left-hand side of the panel, while the “Power Off” LED indicator light is off. To turn the system off, rotate the knob to the “Power Off” position. The “Power Off” LED indicator will display as red, and the light indicator for the fan speed will turn off.
5. IR: This infrared receiver is used by your remote control to change unit settings.

## OPERATION DISPLAY

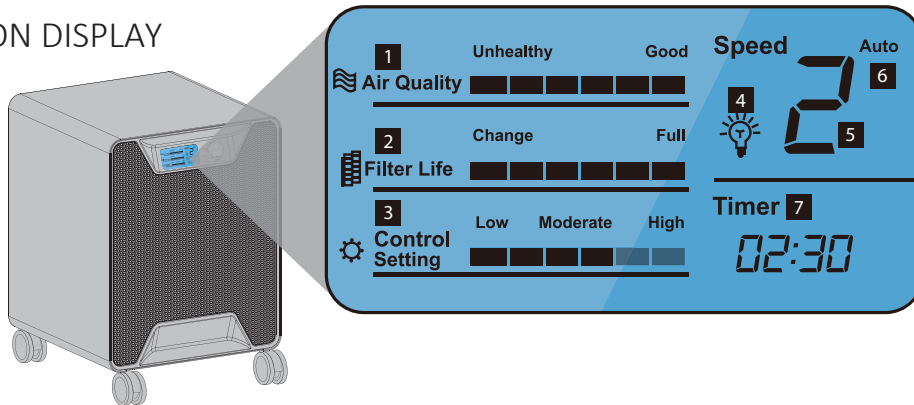

1. Air Quality: The Airgle® system is equipped with an advanced air quality monitoring sensor. The Air Quality Gauge displays the quality of the air in the room – the air you breathe. The six status bars indicate the quality from Unhealthy (one bar) to Good (six bars).

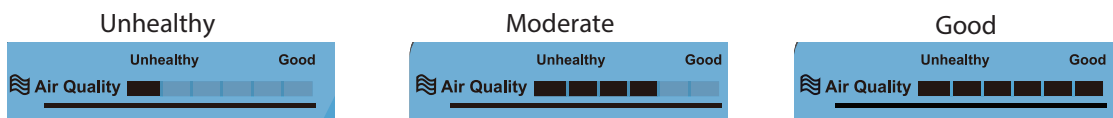

2. Filter Life: This monitor calculates the remaining life of the system’s filters. The calculation takes into account both the already elapsed operation time and fan speed. This allows for a more accurate report on filter life. The six status bars indicate if the filter should be changed (one bar) to when it is at its full life (six bars). When the filter needs attention, the first bar will be blinking.



3. Control Setting: This advanced setting is for users who encounter challenging air pollution environments and/or needs. The default setting is Moderate, which should be ideal for most users. For more information, please see the Control Setting section in this manual.
4. Light Bulb: This indicator displays if you have installed Titanium Pro®. If blinking, it indicates that the Titanium Pro® Module needs to be replaced. For more information, please see the Titanium Pro® section in this manual.

5. Speed: This indicates the speed selected by using the knob on the right-hand side of the panel.
6. Auto: This indicates you have elected to use the Auto-Mode (it is on the right side of the panel).
7. Timer: This indicates how much time is left until the system shuts down (activated by the Timer button on the right-hand side of the panel).

## ADVANCED FUNCTIONS

### TITANIUM PRO® MODULE

Your unit has been pre-installed with the Titanium Pro® module and the light bulb icon will display on your control panel. The light bulb indicates whether your unit has the module installed, and also indicates when it is time to replace the module by blinking. When that time is up, the light bulb icon will start blinking. After you replace the filter and press the Reset button (on the right-hand side of the panel), it will stop blinking. If desired, the Titanium Pro® module can be turned off.

1. With the power turned on, press the Mode button, hold down for more than five seconds and the light bulb indicator on the LCD display will start blinking.
2. When the light bulb is on, release the Mode button to turn on the Titanium Pro® module.
3. When the light bulb is off, release the Mode button to turn off the Titanium Pro® module.

### CONTROL SETTING

The default setting for the unit is “Moderate” and will be displayed as four bars on the control panel. This setting should meet air purification needs in most environments.



1. When you use Models AG600/AG900, make sure the units are powered on (plug in the units and confirm the knob is at the “Speed 1 to 5” position).
2. Press and hold the Timer button for more than five seconds and you will hear a “ding” sound. The Control Setting bars will cycle through High, Moderate, Low, Moderate.....and then start blinking.
3. If you release the Timer button when “High” is blinking, the system is set to High Mode.

Answer the following questions to assess whether you need to change your control setting:

	Yes	No
Are you noticing severe indoor air pollution problems?		
Are you or a member of your family having severe asthma and/or allergy issues?		
Do you want to be able to always set your system to Auto mode?		

Auto Mode: Your system will start on high to purify the air until it senses an extremely low concentration of particles, and then will automatically change itself to the low setting.

	Yes	No
If you answered “Yes” to any of the questions above, you may want to consider changing your setting to “High”. If you answered “No” consider the following question:		
Do you have a relatively clean environment and purchased the unit for general air purification reasons?		

If you answered “Yes” to this question, you may want to consider changing your setting to “Low”.



#### WHAT HAPPENS IN HIGH MODE?

When the unit is set on High, the sensor (on the side of the unit) is more sensitive to the environment. The system will auto-activate when it detects small amounts of particles in the air. Since it is more responsive to these small amounts of particles, it will activate frequently, and this will shorten the life of the filter. However, the air will be more pure in your room.

#### WHAT HAPPENS IN LOW MODE?

When the unit is set on Low, the sensor (on the side of the unit) is less sensitive to the environment. The system does not auto-activate until it senses a medium to high amount of particles in the air. This setting extends the filter life.

## USING THE HANDHELD REMOTE

1. Power: Switch the system on/off.
2. Mode: Change the mode to Auto or Sleep. Press the Mode button and hold five seconds. You can turn on/off the UV lamp.
3. Speed: Regulate fan speed from 1 to 5.
4. Timer: Set Timer from 1 to 12 hours.

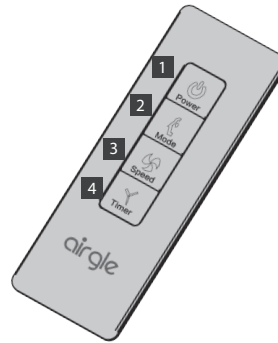

The infrared receiver of the Airgle® system is located in the right-hand bottom corner of the control panel. In order to get the best signal transmission, the remote control should be pointed at the control panel when pressing any button on the remote.

Note: If there are barriers between the remote and the machine, the receiver may not be able to receive the signal. The remote control is pre-loaded with a battery. Please remove the insulation film on the battery before use.

### HANDHELD REMOTE BATTERY REPLACEMENT

1. Open the battery compartment by pressing the small lever to the side and slide the battery compartment out.
2. Remove the used battery.
3. Insert the new battery (3V battery CR2032). Be sure that the (+) and (-) are in the correct position.

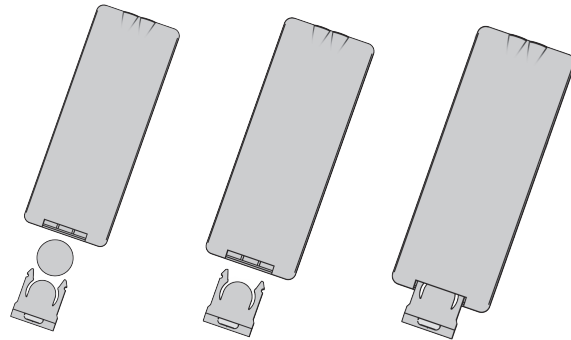

### HANDHELD REMOTE MAINTENANCE

Replace the battery if it cannot get a signal.

4. Be sure the same model battery is replaced.
5. Always put the used battery in a bag before disposal.
6. Keep the battery away from children.



**WARNING:** Chemical Burn Hazard. Keep batteries away from children.

- This Product contains a lithium button/coin cell battery. If a new or used lithium button/coin cell battery is swallowed or enters the body, it can cause severe internal burns and can lead to death in as little as 2 hours. Always completely secure the battery compartment. If the battery compartment does not close securely, stop using the product, remove the batteries, and keep it away from children. If you think batteries might have been swallowed or placed inside any part of the body, seek immediate medical attention.
- The cells shall be disposed of properly, including keeping them away from children.
- Even used cells may cause injury.

# AIRGLE® MOBILE APPLICATION

The Airgle® AG600 Room Air Purifier and AG900 Clean Room Air Purifier have a mobile application with the ability to manage your Airgle® air purifier from your own mobile device. It can be downloaded on both iOS and Android platforms.

## INSTALLING THE APP

### APPLE® iOS DEVICES

- a. Launch the Apple app store on your device and in the search bar, enter "Airgle" and click Search (a). Use the "Get" button to download the app.
- b. Once the app is installed, launch the app and click the "Register" button to set up your Airgle account (b).
- c. Read the Privacy Policy and click "Agree"(c).
- d. Enter your email address or phone number to obtain a verification code(d).
- e. You will be sent a 6-digit verification code(e). Enter this code into the app to confirm your registration.

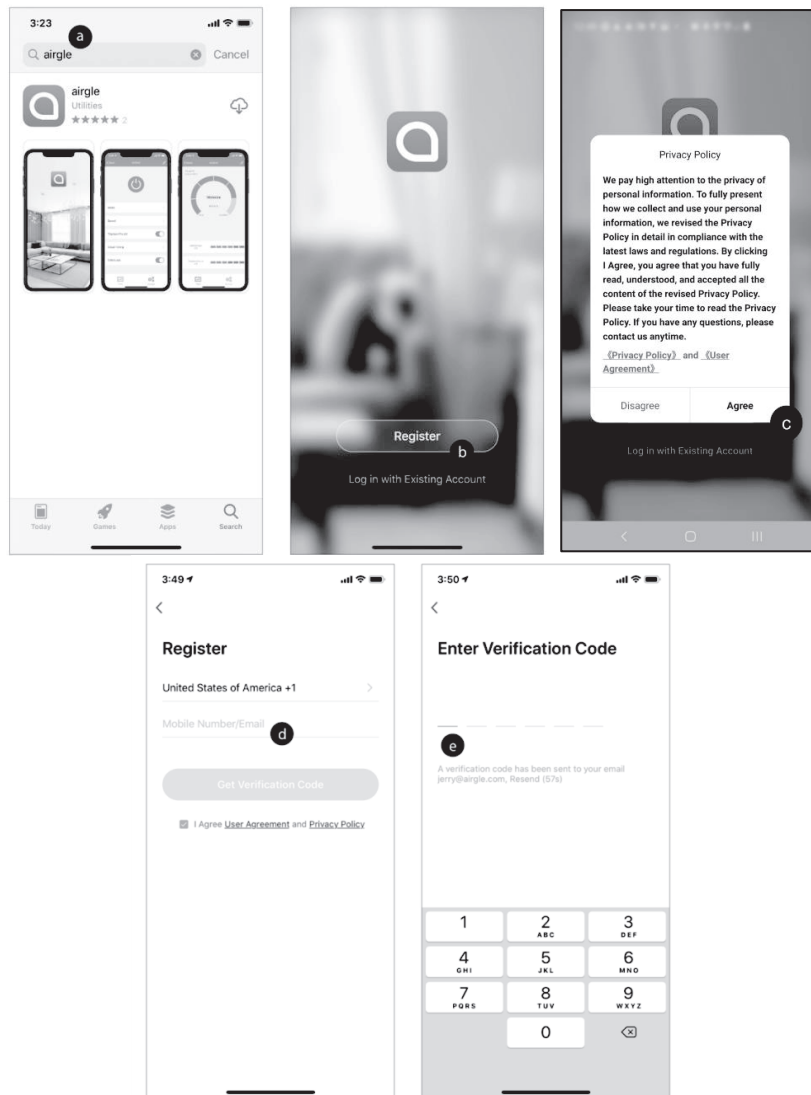

### Android devices

- a. Launch the Google Play store on your device and in the search bar, enter "Airgle" and click Search. Use the "Install" button to download the app(a).
- b. Once the app is installed, launch the app and click the "Register" button to set up your Airgle account(b).
- c. Read the Privacy Policy and click "Agree"(c).
- d. Enter your email address or phone number to obtain a verification code.
- e. You will be sent a 6-digit verification code. Enter this code into the app to confirm your registration.

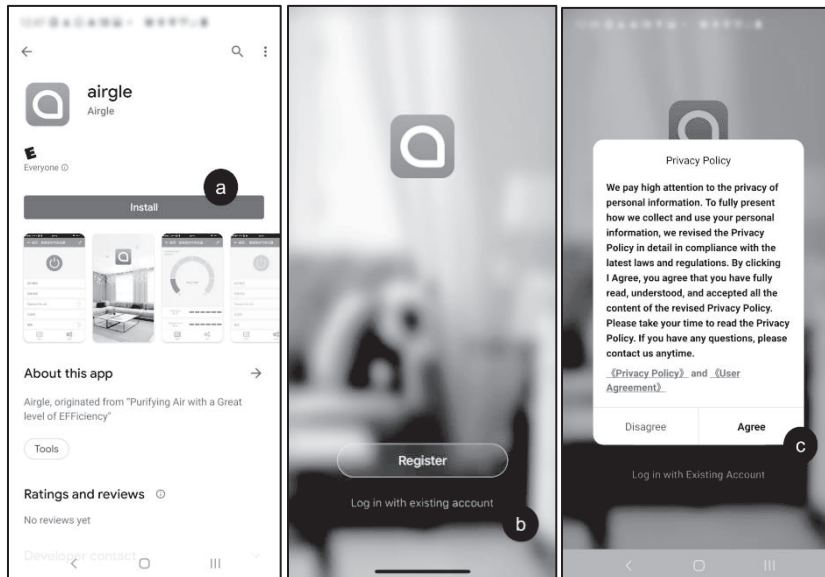

### GET STARTED WITH THE APP

- a. Once fully signed into the app (a), click on the "Device Location Management" button (1) to create a location to control your Airgle devices.
- b. Give your device location a name and set your physical location(b) to get real time weather and air quality data (c). You can also choose which rooms in your location you want to place an Airgle device.
- c. Now you are ready to add devices to your location.

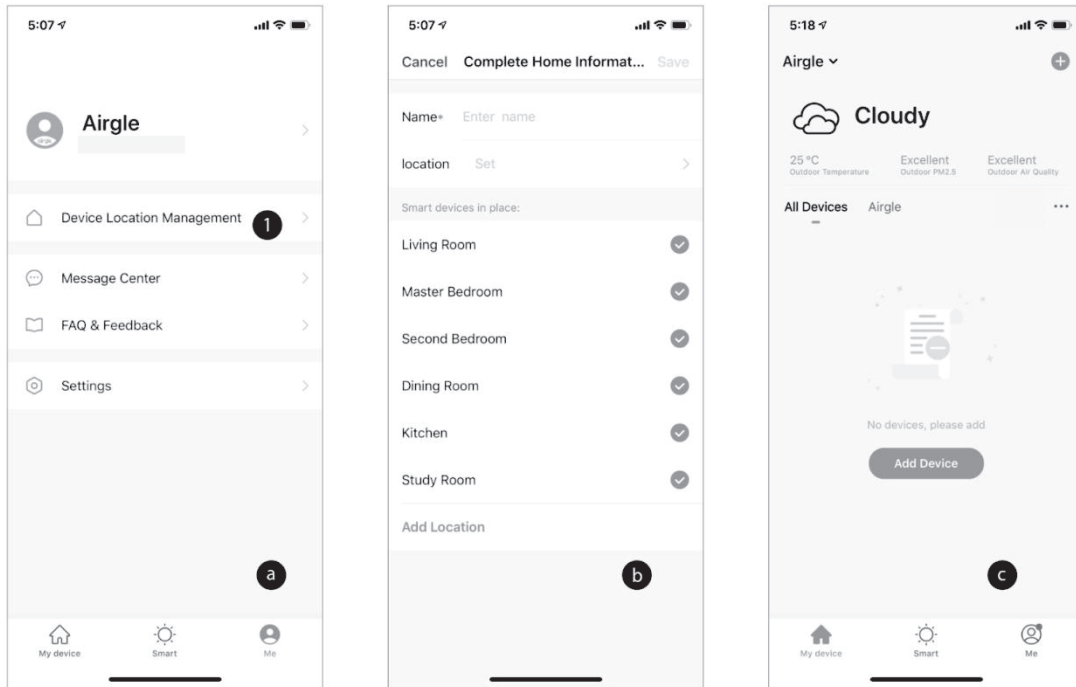

**ADD THE AIRGLE® DEVICE TO YOUR APP**

- a. The "My Device" home screen (1) should now have your Airgle network name in the upper left corner and should show the outdoor weather conditions under the network name. Underneath the weather information, is a list of all the devices in the network. To add a device to the network, click the "Add Device" button (a) or the "+" button in the upper right corner.
- b. On the Add Device screen, click on the "Air Purifier" image (b).
- c. Power on your Airgle® and follow the instructions on the app to connect the device to WiFi. This can be done by pressing and holding the "Reset" button on the control panel for more than 5 seconds. Your device is ready to pair indicated by blinking WiFi icon on the device's control panel (c).
- d. Enter the WiFi password of your network to connect your Airgle® to your network(d).

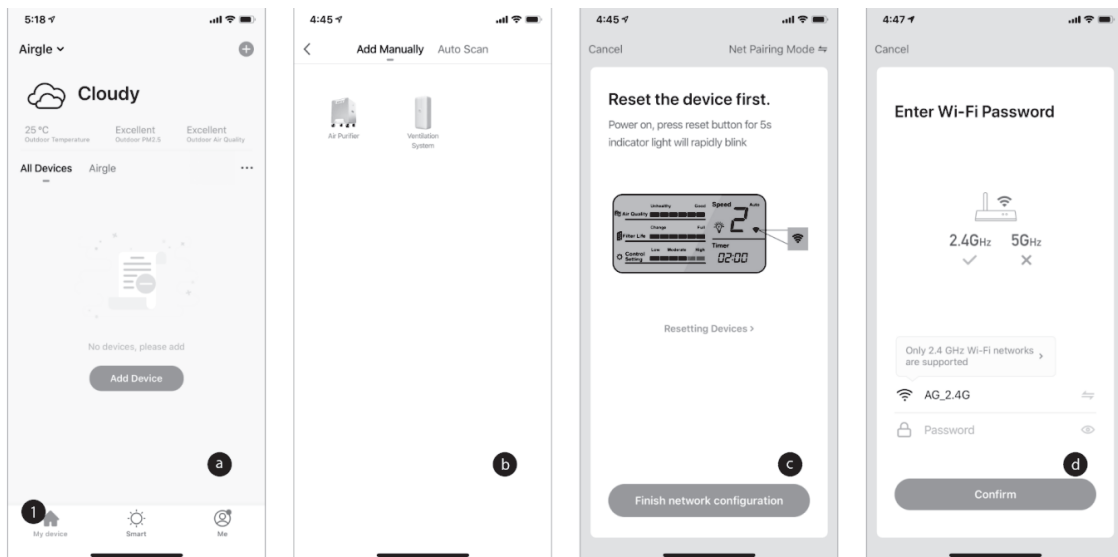

## ADDING AN AIRGILE DEVICE (AP MODE)

- e. Add your device to advanced setting (AP Mode) (a).
  1. The default networking mode is "EZ Mode".
  2. If you have different router and setting, you will need to connect via AP Mode by click the "Net Pairing Mode"(1) at the upper right corner of "EZ mode" homepage to switch the networking mode (2).

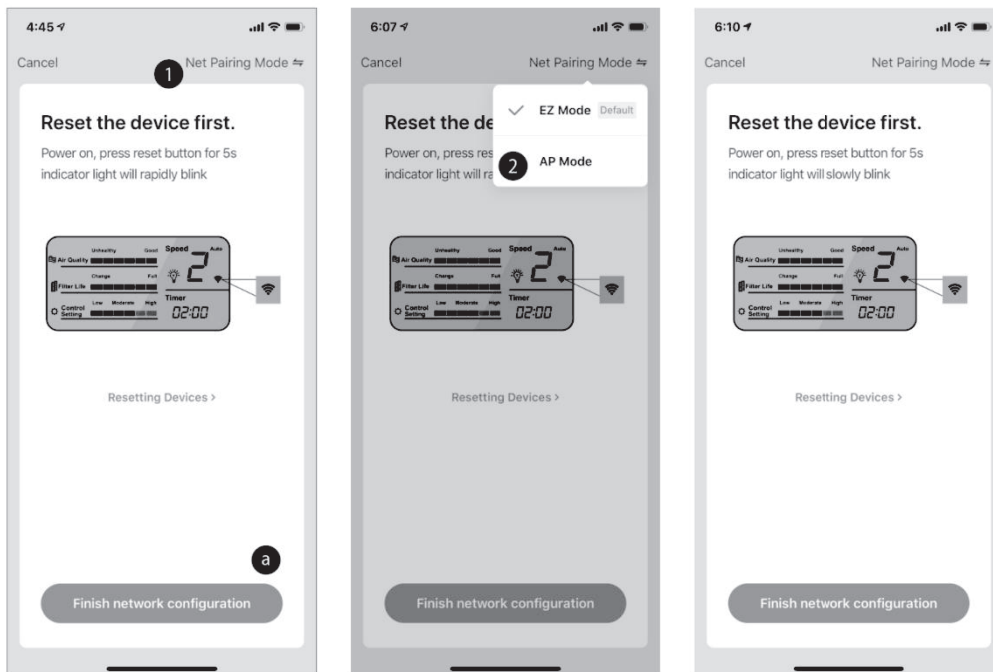

3. Set the product's networking mode to correspond to the app.
  - f. The factory default setting is "EZ Mode". You may switch to "AP Mode" within 60 seconds after unit is powered on.
  - g. To switch between the modes, press "Reset" button and hold for 5 seconds, release the button after hearing the "ding ding" sound, WIFI indicator will blink on LCD.
    - 1\EZ Mode: The WIFI indicator on the LCD display blinks at a fast pace (2 blinks per 1 second);
    - 2\AP Mode: The WIFI indicator on the LCD display blinks at a slow pace (2 blink every 3 seconds);
  - h. Connect the product in the AP mode.

Use your mobile APP to connect the mobile phone WIFI to the product hotspot. The product hotspot WIFI name should be "SmartLIFE-XXXX". The selected network then prompts to continue adding products.

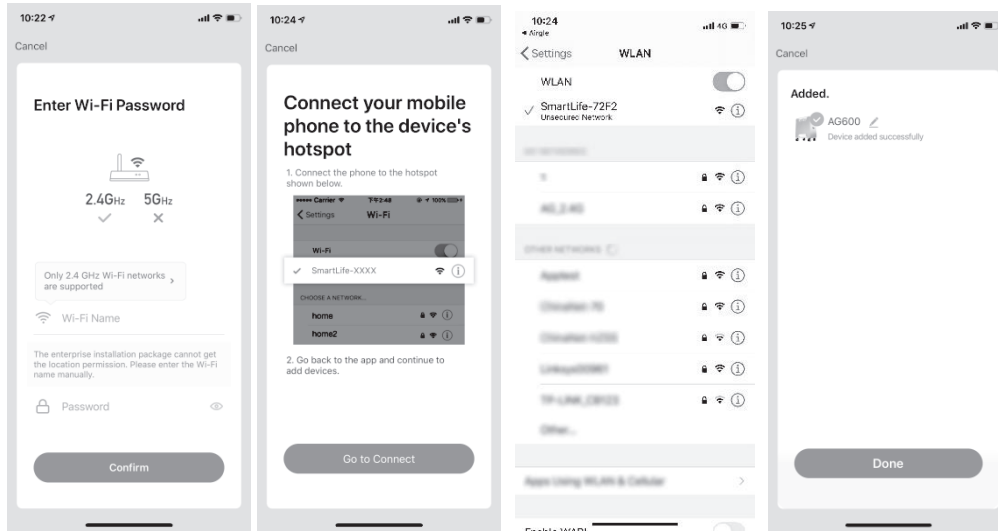

## CONTROL A SINGLE AIRGLE® DEVICE

Now that your Airgle® AG600/900 device is connected to your mobile app, you can control the air purifier remotely from your phone.

- a. Start by clicking on your device name(a). You can then control your device using the buttons on the Control tab (b).
1. Power on/off the device (1)
2. Switch between the operating modes (Manual, Automatic, Sleep) (2)
3. Change the fan speed (1, 2, 3, 4, 5 - Turbo) (3)
4. Turn on/off the Titanium Pro® UV module (4)
5. Put your device on a schedule by using the Cloud Timing feature (5)
6. Enable/disable the Child Lock safety feature (6). This disables all buttons on the control panel of your Airgle® Air Purifier.
- b. You can also view air quality data and filter life status on the Data tab (c).
7. This chart indicates the current air quality level surrounding your Airgle® air purifier (7).
8. This chart indicates the life of the cHEPA/carbon filter (8).
9. This chart indicates the life of the Titanium Pro® UV module (9).

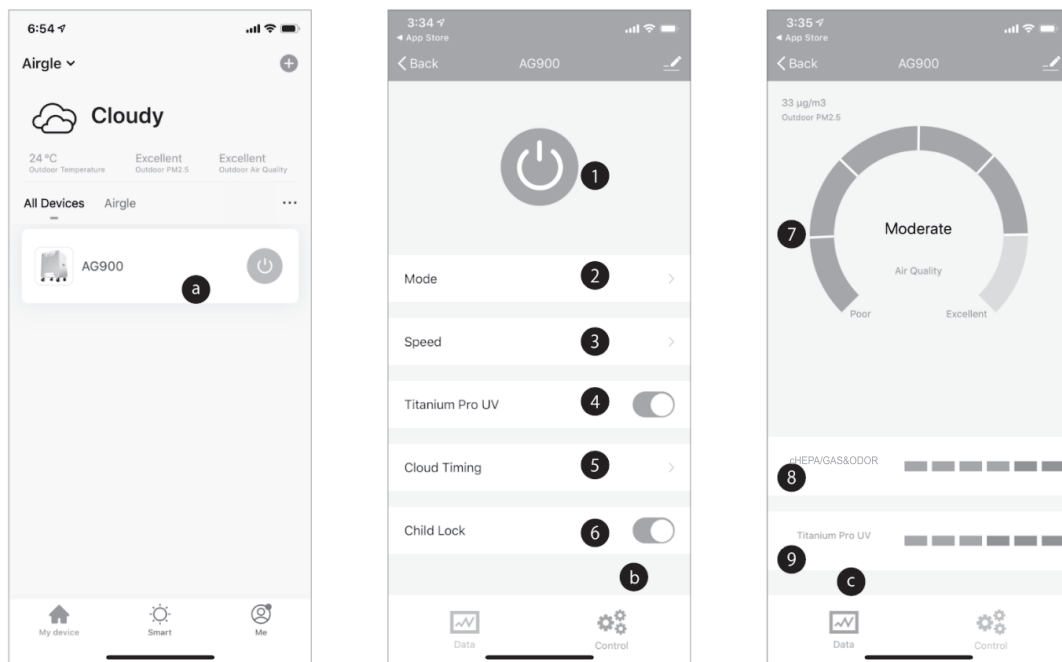

10. On the Control page (d), use the "Cloud Timing" feature to put your device or group of devices on a schedule.
  - a. Select "Cloud Timing" to open the timing control interface (1).
  - b. View any existing schedules or create a new one by clicking "Add Schedule" (2).
  - c. Select a time to turn on your air purifier.
  - d. Select "Repeat" to set the day to be repeated in a week (3).
  - e. Select "Power" and select the action to be performed "ON" if you want the timing to turn your device on or "OFF" if you want this timing to turn your device off (4).
  - f. Repeat the above setting actions to set the shutdown time.



- g. After completing the settings, the product can be turned on and off regularly at the set times and days (5).

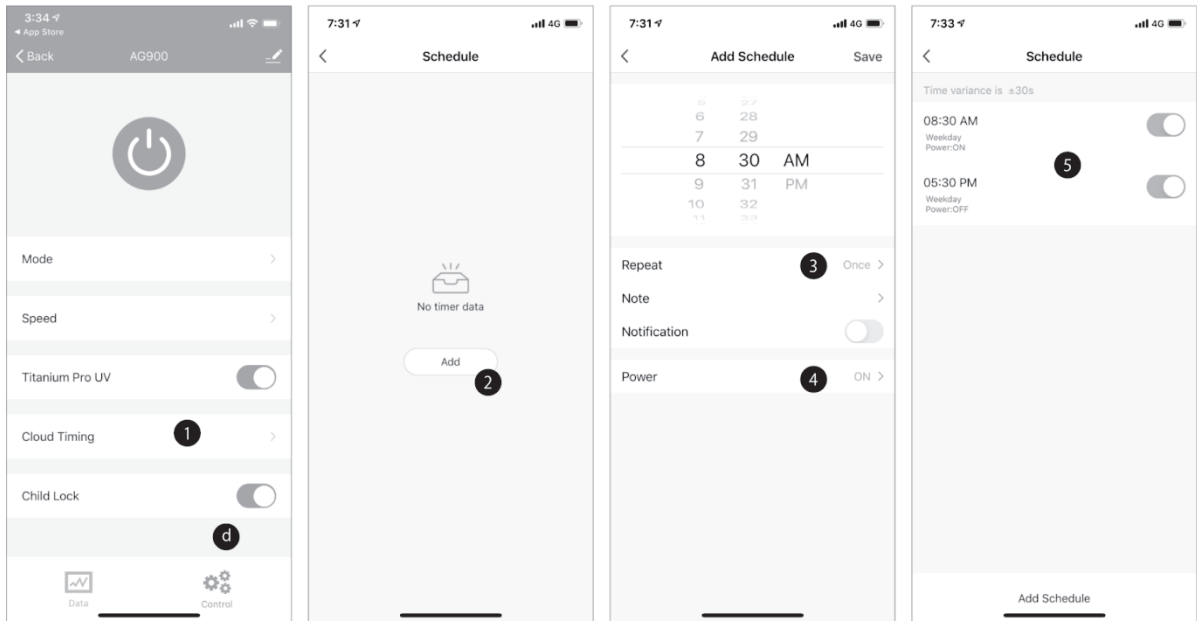

## CONTROLLING MULTIPLE AIRGLE DEVICES

If you have other Airgle® devices in the same location, you can control groups or all of them using the mobile application with a single click or automation. Each group contains up to 100 devices and multiple groups can be created.

1. On the "My Device" page, click on a connected air purifier to enter the control page (1).
2. Click the pencil icon in the upper right corner to view the More options of the product (2).
3. Select the "Create Group" button to create a group of devices (3).
4. The "Select Device" page will show a list of other connected Airgle® devices (4), select all devices you want to add to the group and click "Confirm" (5).

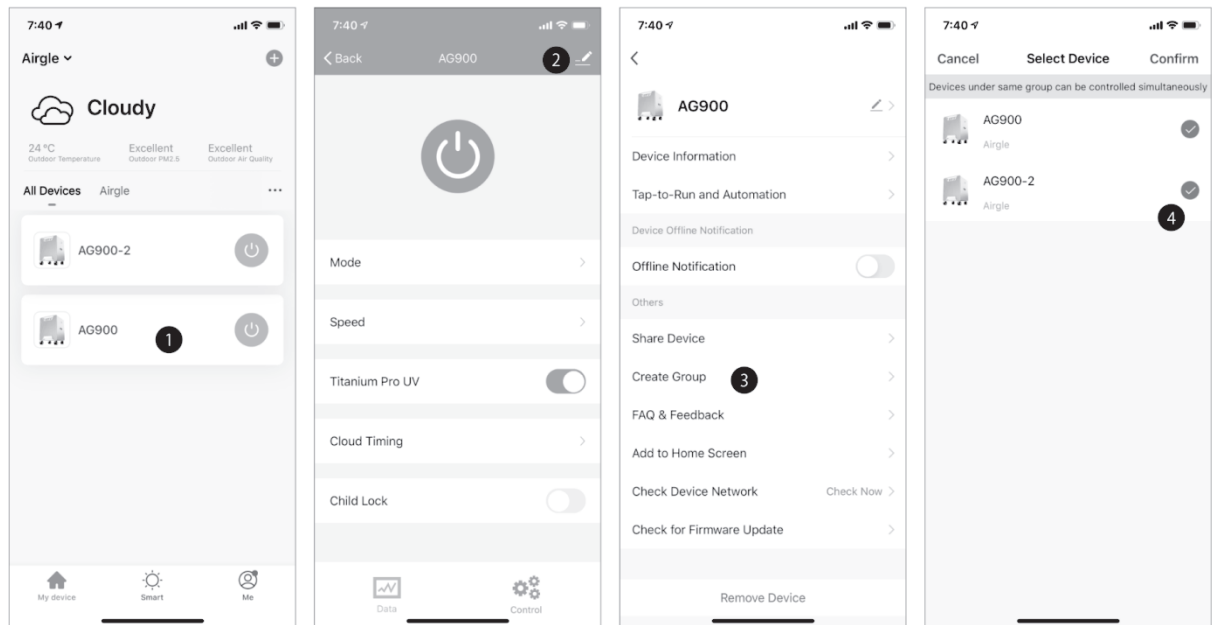

5. Enter a descriptive group name which will be easy to recognize on the "My Device" page.
6. You can now view the devices in the group in "All Devices". (There is a group symbol after the group name for identification) (6). By clicking on this, you can control the group of devices with a single click like powering on/off, adjusting the fan speed and other functions.

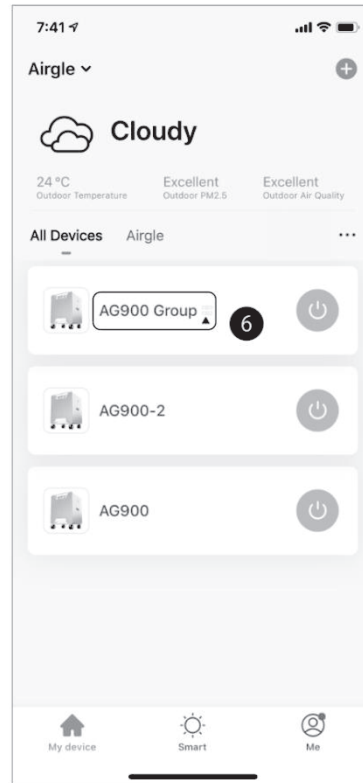
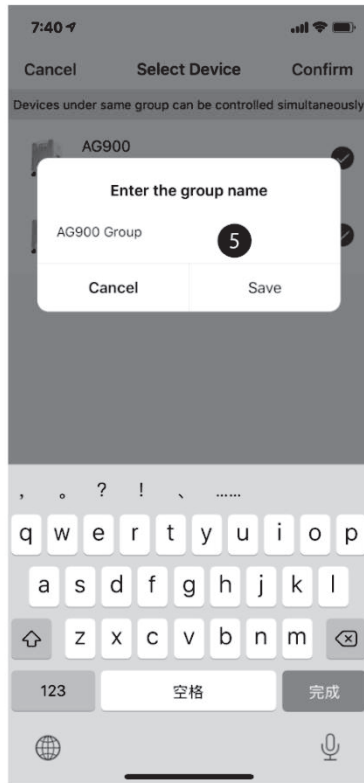

## USE THE AUTOMATION FEATURES

Through the mobile application, not only can you perform general product control like powering on the air purifier or changing the fan speed – but you can also control the air purifier intelligently using smart automation. These automation features can also be used for groups of devices:

1. On the bottom of the app, switch to the "Smart" screen. This is your home page for intelligent product control and smart automation. Click the "+" button (1).
2. Click the "Launch Tap to Run" button to create a one-click shortcut for your device or group of devices (2).
3. Click the "Run the Device" button to select which device or group of devices to apply this shortcut to (3).
4. Choose a device or group of devices in the "All Devices" list (4). If you do not see your device listed, ensure you've added it to your account by following the directions in the *ADD THE AIRGLE® DEVICE TO YOUR APP* section.

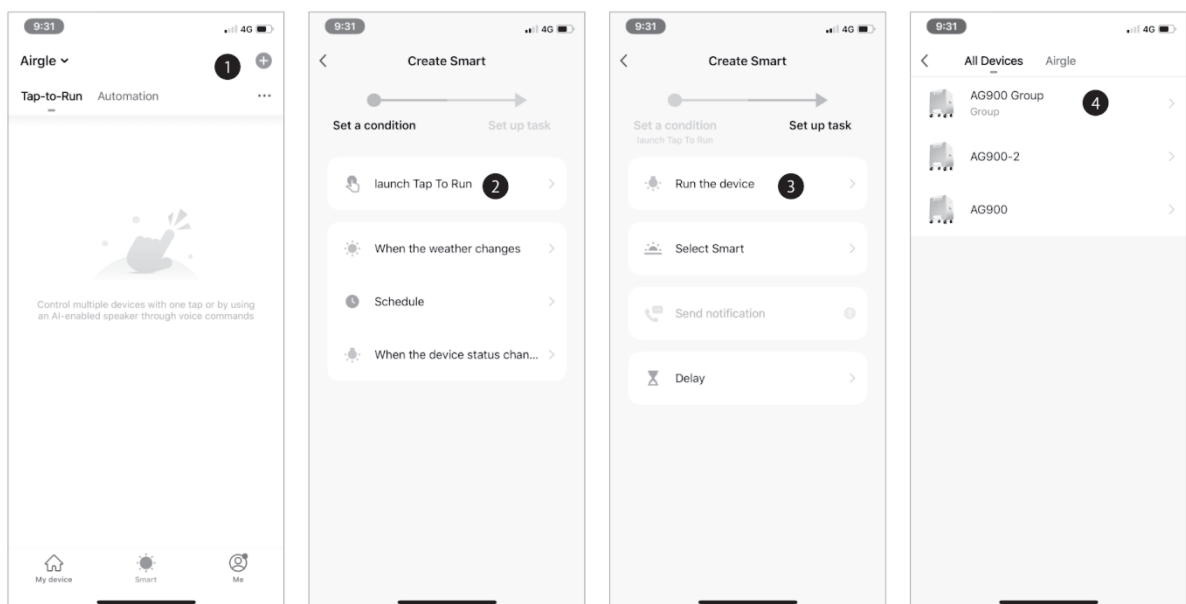

5. Now that you've selected the device/group of devices for the shortcut, you can select the function to be performed using the shortcut. In this example, let's choose "Power" to power on/off the device (5).
6. After choosing "Power", you are given the two options of on or off (6). Make your selection and click "Save".
7. You will then return to the Select Function screen (7) where you can choose from a multitude of options:
  - a. The "Next" button will bring you to the Conditions screen described below(a).
  - b. The "Speed" button allows you to choose a fan speed(b).
  - c. The "Child Lock" button allows you to enable the Child Lock safety feature(c). This disables all buttons on the control panel of your devices.
  - d. The "Titanium Pro UV" button allows you to turn on/off the Titanium Pro® UV module(d).

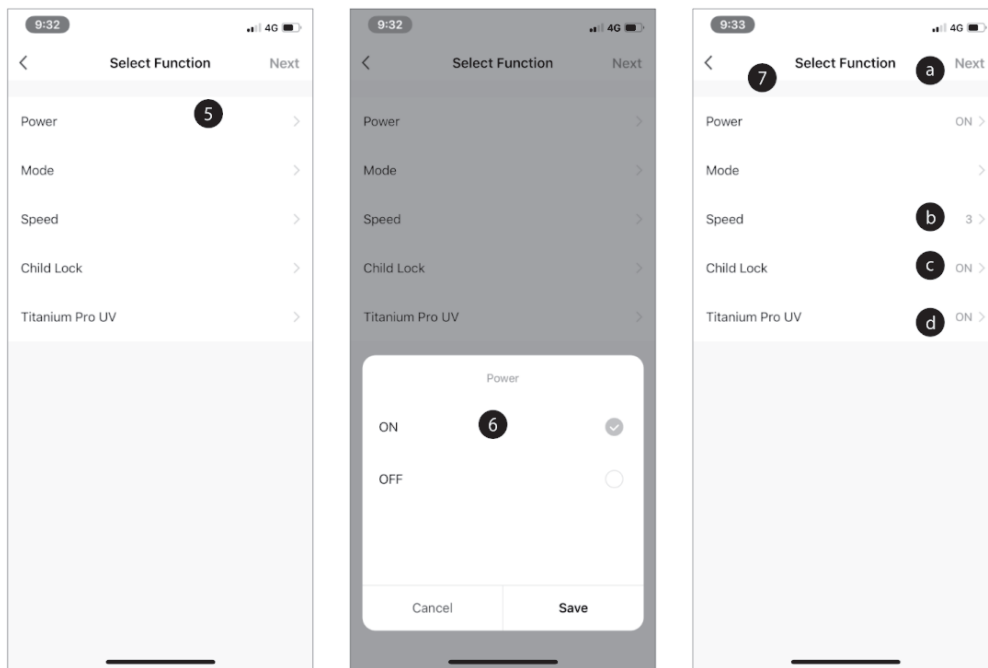

8. After selecting "Next" on the previous screen, you will then need to set the conditions under which your shortcut will run.
9. Finally, you will choose how your shortcut will be displayed on your Smart page. You can edit the name of the short cut for easy reference later, set the color of the tile, and whether it will be displayed on the Smart page (8).
10. Your finalized shortcut is now ready to view on the Smart page (9).

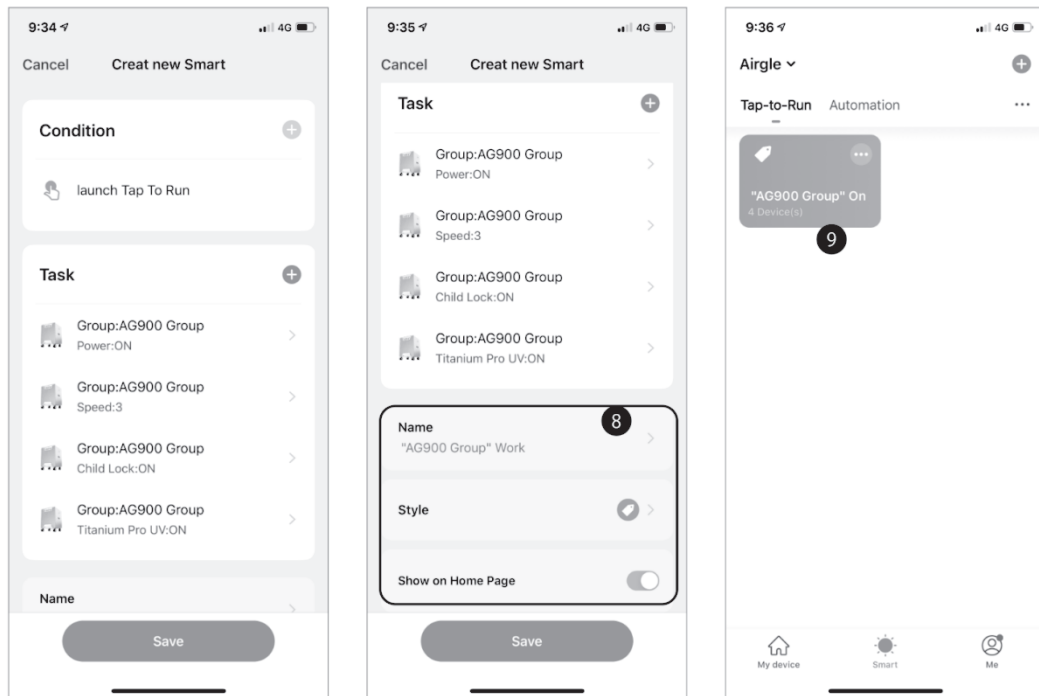

An "Automation" is a series of events that will happen automatically based on conditions you define. For example – you could create an automation to power off any devices after 9 PM.

1. Click "Automation" tab in the Smart page to get started and click the "+" button (1).
2. Click the "Schedule" button to add a schedule for the automation (2).
3. Set an execution time and click the "Repeat" button to indicate for which days to repeat the automation (3).
4. Select the days of the week you want the automation to take place (4).
  - a. Click the "<" button to return to the "Schedule" screen (a).

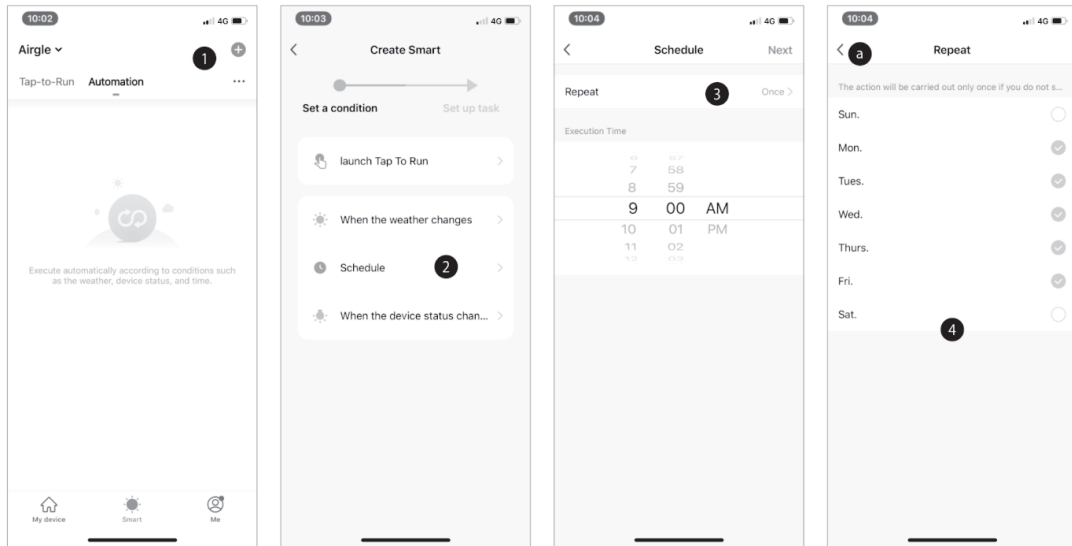

5. Click the "Next" button to continue to select the device(s) and add conditions (5).
6. Click the "Run the device" button to indicate which device or group of devices the automation should control (6).
7. Choose the condition under which the automation will run and the device(s) it will run (7).
8. Give the Automation a name (something that will help you remember its function) and choose a background color for the tile on the "Smart" page (8).
9. Finally, view the Automation created on the "Smart" page (9).

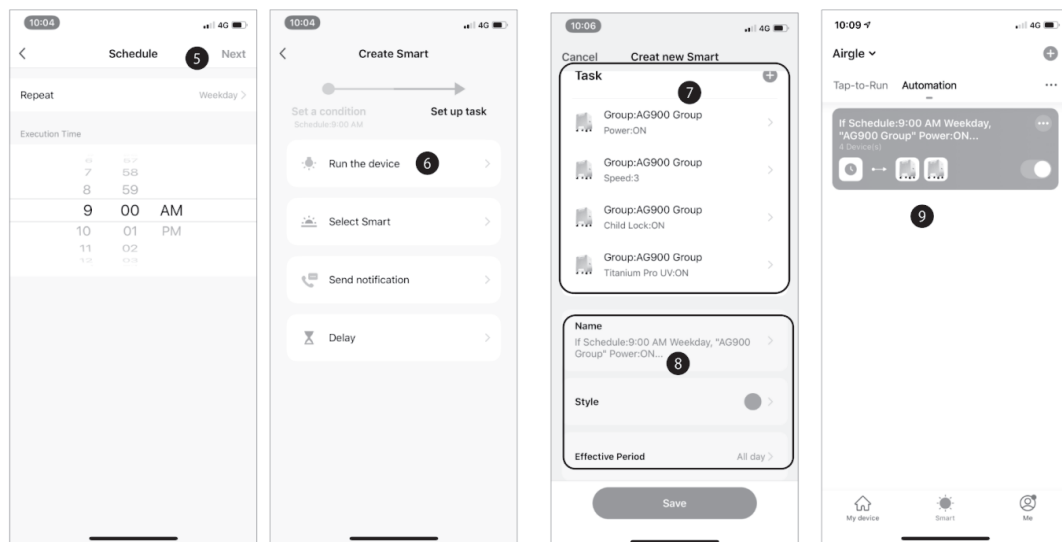

## LIMITED WARRANTY

Airgle Corporation (hereinafter "Airgle") warrants to the original purchaser of this product, who purchased their Airgle® Air Purifier from an Airgle authorized distributor or dealer:

- That this product, including all of its Airgle authorized parts, is free of defects in material and workmanship.
- That this product, if found to be defective within the stated warranty period, will be repaired free of charge to the consumer (both parts and labor) by an authorized Airgle service agent.
- The warranty period for commercial use is one year and for non-commercial use is five (5) years from the date of purchase.

## COMMERCIAL USE

Airgle® AG600 Room Air Purifier and AG900 Clean Room Air Purifier are warranted for a period of twelve (12) months from the date of purchase for commercial use.

## WHAT IS NOT COVERED BY THIS WARRANTY

This warranty does not cover the following:

- Defects resulting from damage caused by repairs, service, or alterations to the appliance performed by a service facility not authorized by Airgle.
- Defects resulting from negligence, abuse, misuse, improper or abnormal usage or maintenance of the product its parts or accessories.
- Ordinary wear or cosmetic damage (scuffs, scratches, gouges, dents, etc.) shall not be considered a defect in materials or workmanship.



## SERVICE

For service under this Limited Warranty or for information you may need about the product, please visit our service website at [www.airgle.com/service-and-support/](http://www.airgle.com/service-and-support/) or call our service hotline at (866) 501-7750.

### User Servicing Instructions

- 1) Risk of fire. Do not replace attachment plug. Contains a safety device (fuse) that should not be removed. Discard product if the attachment plug is damaged.
- 2) Replace fuse a blown device: (Only USA)
  - a. Grasp plug and remove from the receptacle or other outlet device. Do not unplug by pulling on cord.
  - b. Open fuse cover. Slide open fuse access cover on top of attachment plug towards blades.
  - c. Remove fuse carefully. Push the fuse from the other side or turn fuseholder over to remove fuse.
  - d. Risk of fire. Replace fuse only with 5 Amp, 125 Volt fuse.
  - e. Close fuse cover. Slide closed the fuse access cover on top of attachment plug.

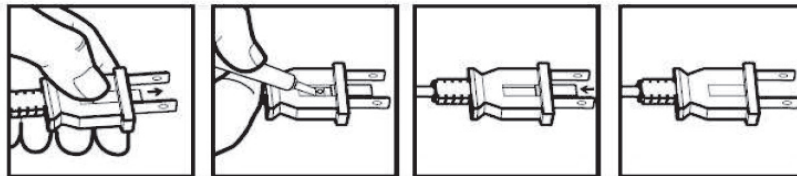

## SPECIFICATIONS

Model Name:	Airgle Room Air Purifier (AG600)	Airgle Clean Room Air Purifier (AG900)
Maximum Clean air delivery	200cfm	400cfm
Fan Speeds:	1 to 5	1 to 5
Noise(dB):	32 to 65	32 to 68
Power Consumption (With WIFI):	1.2W (Standby) to 56W	1.2W (Standby) to 120W
Housing Material:	Aluminum + Steel	Aluminum + Steel



airgle®

Precisely Pure

AIRGLE® CUSTOMER CARE

Toll-Free:(866) 501-7750

[info@airgle.com](mailto:info@airgle.com)

[www.airgle.com](http://www.airgle.com)